

TOSHIBA PHOTOCOUPLER GaAs IRED & PHOTO-TRIAC

# TLP3021(S),TLP3022(S),TLP3023(S)

OFFICE MACHINE  
 HOUSEHOLD USE EQUIPMENT  
 TRIAC DRIVER  
 SOLID STATE RELAY

The TOSHIBA TLP3021 (S), TLP3022 (S) and TLP3023 (S) consist of photo-triac optically coupled to a gallium arsenide infrared emitting diode in a six lead plastic DIP.

- Peak Off-State Voltage : 400 V (min)
- Trigger LED Current : 15 mA (max) (TLP3021(S))  
 10 mA (max) (TLP3022(S))  
 5 mA (max) (TLP3023(S))
- On-State Current : 100 mA (max)
- Isolation Voltage : 5000Vrms(Min)
- UL Recognized : UL1577,File No.E67349
- SEMKO Approved : SS EN60065  
 SS EN60950, File No.9841105
- BSI Approved : BS EN60065, File No.8385  
 BS EN60950, File No.8386
- Option (D4) type  
 VDE approved: DIN EN60747-5-2  
 Approved No. 40009302  
 Maximum operating insulation voltage: 890V<sub>PK</sub>  
 Highest permissible over voltage: 8000V<sub>PK</sub>  
 (Note):When a EN60747-5-2 approved type is needed,  
 please designate the "Option (D4)"

● Construction Mechanical Rating

	7.62 mm pich Standard Type	10.16 mm pich TLPxxxxF Type
Creepage Distance	7.0 mm (Min)	8.0 mm (Min)
Clearance	7.0 mm (Min)	8.0 mm (Min)
Insulation Thickness	0.5 mm (Min)	0.5 mm (Min)

Unit: mm

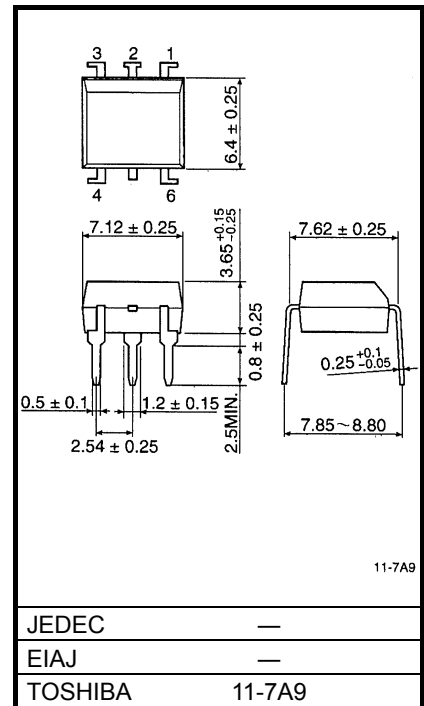

Weight : 0.39g

**Pin Configuration (top view)**

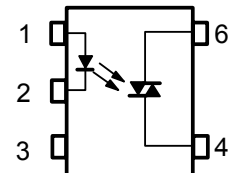

- 1: Anode
- 2: Cathode
- 3: N.C.
- 4: Terminal 1
- 6: Terminal 2

## Absolute Maximum Ratings (Ta=25°C)

CHARACTERISTIC		SYMBOL	RATING	UNIT
LED	Forward Current	$I_F$	50	mA
	Forward Current Derating (Ta≥53°C)	$\Delta I_F / ^\circ\text{C}$	-0.7	mA / °C
	Peak Forward Current (100μs pulse, 100pps)	$I_{FP}$	1	A
	Power Dissipation	$P_D$	100	mW
	Power Dissipation Derating (Ta≥25°C)	$\Delta P_D / ^\circ\text{C}$	-1.0	mW / °C
	Reverse Voltage	$V_R$	5	V
	Junction Temperature	$T_j$	125	°C
DETECTOR	Off-State Output Terminal Voltage	$V_{DRM}$	400	V
	On-State RMS Current	Ta=25°C	100	mA
		Ta=70°C	50	
	On-State Current Derating (Ta≥25°C)	$\Delta I_T / ^\circ\text{C}$	-1.1	mA / °C
	Peak On-State Current (100μs pulse, 120pps)	$I_{TP}$	2	A
	Peak Nonrepetitive Surge Current (Pw=10ms, DC=10%)	$I_{TSM}$	1.2	A
	Power Dissipation	$P_D$	300	mW
	Power Dissipation Derating (Ta≥25°C)	$\Delta P_D / ^\circ\text{C}$	-4.0	mW / °C
	Junction Temperature	$T_j$	115	°C
	Storage Temperature Range	$T_{stg}$	-55~150	°C
Operating Temperature Range	$T_{opr}$	-40~100	°C	
Lead Soldering Temperature (10s)	$T_{sol}$	260	°C	
Total Package Power Dissipation	$P_T$	330	mW	
Total Package Power Dissipation Derating (Ta≥25°C)	$\Delta P_T / ^\circ\text{C}$	-4.4	mW / °C	
Isolation Voltage (AC, 1min., R.H.≤60%)	(Note 2) $BV_S$	5000	Vrms	

Note: Using continuously under heavy loads (e.g. the application of high temperature/current/voltage and the significant change in temperature, etc.) may cause this product to decrease in the reliability significantly even if the operating conditions (i.e. operating temperature/current/voltage, etc.) are within the absolute maximum ratings.

Please design the appropriate reliability upon reviewing the Toshiba Semiconductor Reliability Handbook ("Handling Precautions"/"Derating Concept and Methods") and individual reliability data (i.e. reliability test report and estimated failure rate, etc).

(Note 2) Device considered a two terminal device :Pins1,2 and 3 shorted together and pin4 and pin6 shorted together.

## Recommended Operating Conditions

CHARACTERISTIC	SYMBOL	MIN.	TYP.	MAX.	UNIT
Supply Voltage	$V_{AC}$	—	—	120	$V_{ac}$
Forward Current	$I_F^*$	15	20	25	mA
Peak On-State Current	$I_{TP}$	—	—	1	A
Operating Temperature	$T_{opr}$	-25	—	85	°C

Note: Recommended operating conditions are given as a design guideline to obtain expected performance of the device. Additionally, each item is an independent guideline respectively. In developing designs using this product, please confirm specified characteristics shown in this document.

\*In The case of TLP3022

## Individual Electrical Characteristics (Ta=25°C)

CHARACTERISTIC		SYMBOL	TEST CONDITION	MIN.	TYP.	MAX.	UNIT
LED	Forward Voltage	$V_F$	$I_F = 10 \text{ mA}$	1.0	1.15	1.3	V
	Reverse Current	$I_R$	$V_R = 5 \text{ V}$	—	—	10	$\mu\text{A}$
	Capacitance	$C_T$	$V = 0, f = 1\text{MHz}$	—	10	—	pF
DETECTOR	Peak Off-State Current	$I_{DRM}$	$V_{DRM} = 400\text{V}$	—	10	1000	nA
	Peak On-State Voltage	$V_{TM}$	$I_{TM} = 100\text{mA}$	—	1.7	3.0	V
	Holding Current	$I_H$	—	—	0.6	—	mA
	Critical Rate of Rise of Off-State Voltage	$dv/dt$	$V_{in} = 120\text{Vrms}, T_a = 85^\circ\text{C}$ (Fig.1)	200	500	—	$\text{V}/\mu\text{s}$
	Critical Rate of Rise of Commutating Voltage	$dv/dt(c)$	$V_{in} = 30\text{Vrms}, I_T = 15\text{mA}$ (Fig.1)	—	0.2	—	$\text{V}/\mu\text{s}$

## Coupled Electrical Characteristics (Ta=25°C)

CHARACTERISTIC		SYMBOL	TEST CONDITION	MIN.	TYP.	MAX.	UNIT
Trigger LED Current	TLP3021(S)	$I_{FT}$	$V_T = 3\text{V}$	—	—	15	mA
	TLP3022(S)			—	5	10	
	TLP3023(S)			—	—	5	
Capacitance (Input to Output)		$C_S$	$V_S = 0, f = 1\text{MHz}$	—	0.8	—	pF
Isolation Resistance		$R_S$	$V_S = 500\text{V} (\text{R.H.} \leq 60\%)$	$5 \times 10^{10}$	$10^{14}$	—	$\Omega$
Isolation Voltage		$BV_S$	AC, 1minute	5000	—	—	Vrms
			AC, 1second, in oil	—	10000	—	Vdc
			DC, 1minute, in oil	—	10000	—	

Fig. 1  $dv/dt$  test circuit

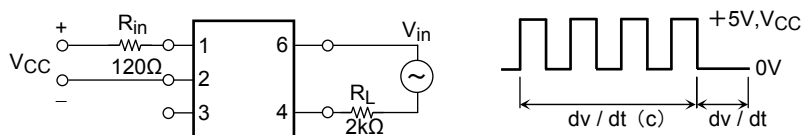

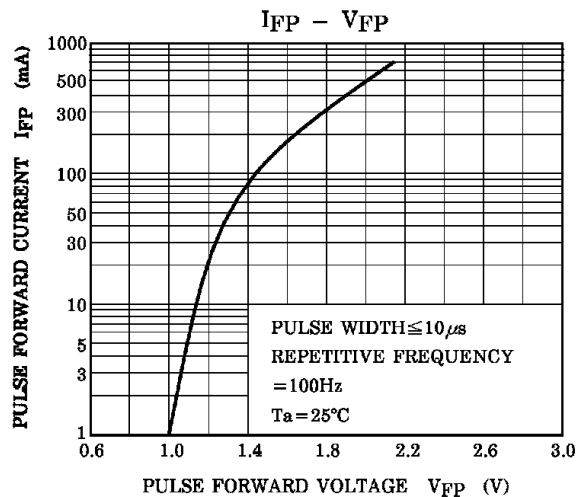
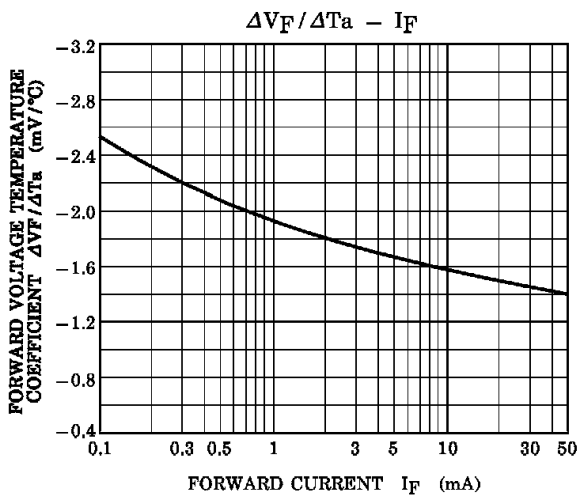
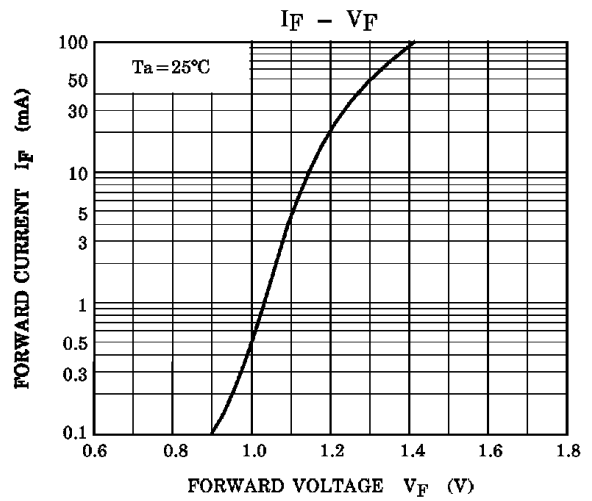
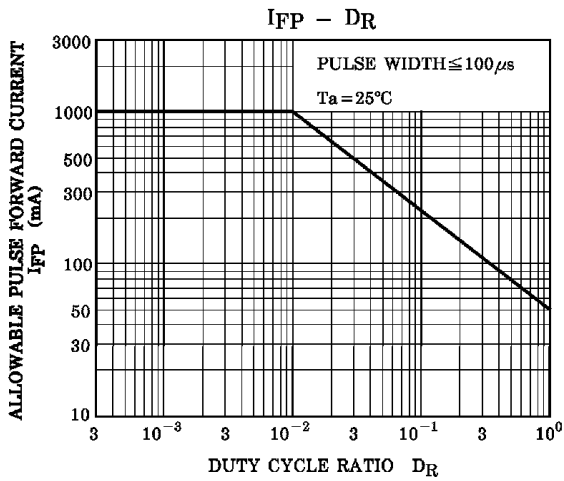
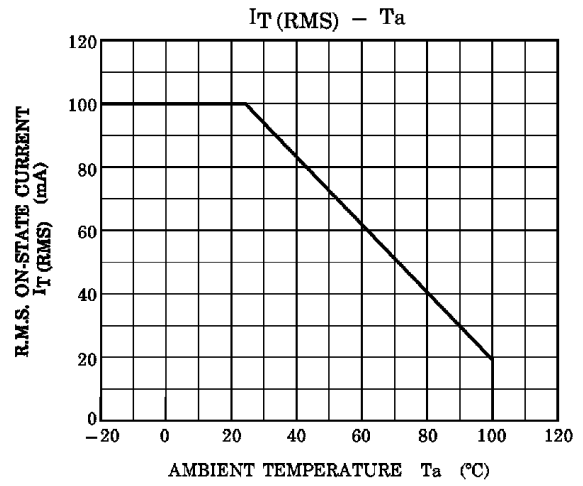
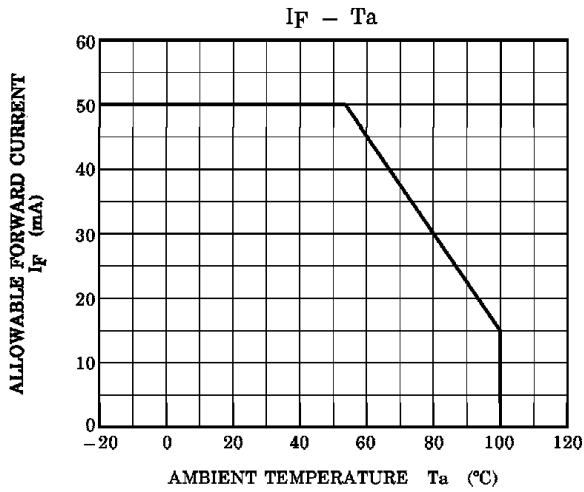

NORMALIZED  $I_{FT} - T_a$

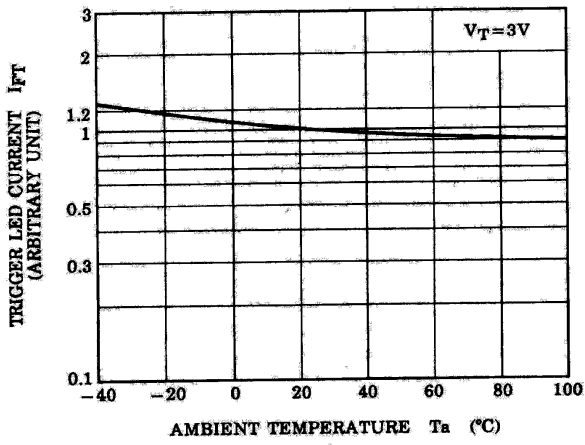

NORMALIZED  $I_H - T_a$

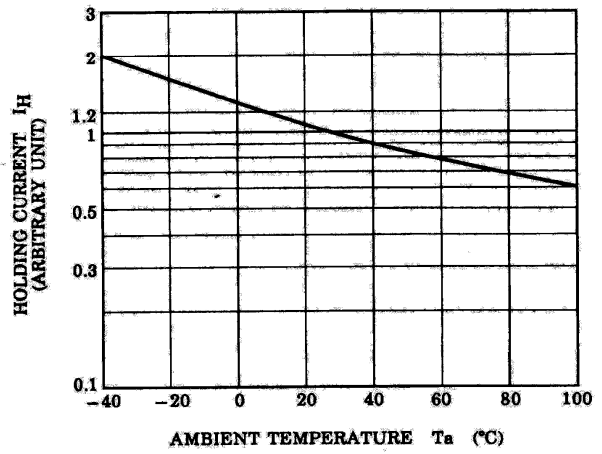

NORMALIZED  $I_{DRM} - T_a$

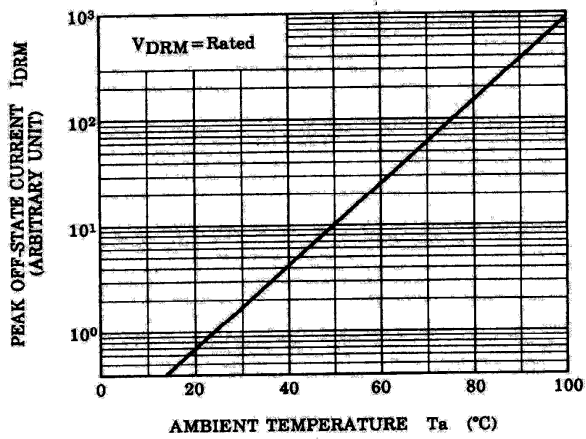

NORMALIZED  $V_{DRM} - T_a$

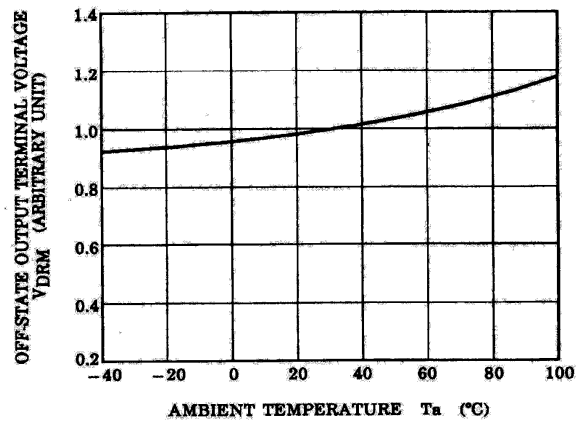

NORMALIZED LED CURRENT  
- LED CURRENT PULSE WIDTH

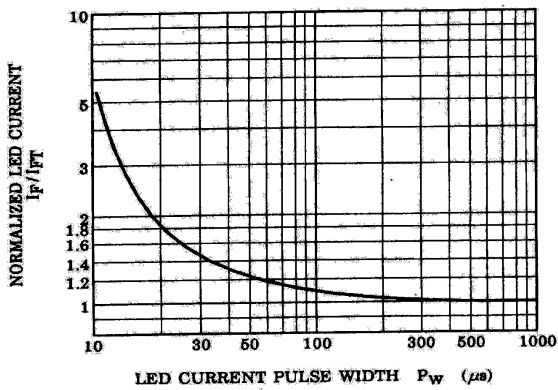

**RESTRICTIONS ON PRODUCT USE**

20070701-EN

- The information contained herein is subject to change without notice.
- TOSHIBA is continually working to improve the quality and reliability of its products. Nevertheless, semiconductor devices in general can malfunction or fail due to their inherent electrical sensitivity and vulnerability to physical stress. It is the responsibility of the buyer, when utilizing TOSHIBA products, to comply with the standards of safety in making a safe design for the entire system, and to avoid situations in which a malfunction or failure of such TOSHIBA products could cause loss of human life, bodily injury or damage to property.  
In developing your designs, please ensure that TOSHIBA products are used within specified operating ranges as set forth in the most recent TOSHIBA products specifications. Also, please keep in mind the precautions and conditions set forth in the "Handling Guide for Semiconductor Devices," or "TOSHIBA Semiconductor Reliability Handbook" etc.
- The TOSHIBA products listed in this document are intended for usage in general electronics applications (computer, personal equipment, office equipment, measuring equipment, industrial robotics, domestic appliances, etc.). These TOSHIBA products are neither intended nor warranted for usage in equipment that requires extraordinarily high quality and/or reliability or a malfunction or failure of which may cause loss of human life or bodily injury ("Unintended Usage"). Unintended Usage include atomic energy control instruments, airplane or spaceship instruments, transportation instruments, traffic signal instruments, combustion control instruments, medical instruments, all types of safety devices, etc.. Unintended Usage of TOSHIBA products listed in this document shall be made at the customer's own risk.
- The products described in this document shall not be used or embedded to any downstream products of which manufacture, use and/or sale are prohibited under any applicable laws and regulations.
- The information contained herein is presented only as a guide for the applications of our products. No responsibility is assumed by TOSHIBA for any infringements of patents or other rights of the third parties which may result from its use. No license is granted by implication or otherwise under any patents or other rights of TOSHIBA or the third parties.
- GaAs(Gallium Arsenide) is used in this product. The dust or vapor is harmful to the human body. Do not break, cut, crush or dissolve chemically.
- Please contact your sales representative for product-by-product details in this document regarding RoHS compatibility. Please use these products in this document in compliance with all applicable laws and regulations that regulate the inclusion or use of controlled substances. Toshiba assumes no liability for damage or losses occurring as a result of noncompliance with applicable laws and regulations.