



# S3A~S3M

## SURFACE MOUNT RECTIFIER

**VOLTAGE** 50 to 1000 Volts    **CURRENT** 3.0 Amperes

**SMC/DO-214AB**    Unit: inch (mm)

### FEATURES

- Plastic package has Underwriters Laboratory Flammability Classification 94V-O
- For surface mounted applications
- Low profile package
- Built-in strain relief
- Easy pick and place
- glass passivated junction
- In compliance with EU RoHS 2002/95/EC directives

### MECHANICAL DATA

- Case: JEDEC DO-214AB molded plastic
- Terminals: Solder plated, solderable per MIL-STD-750, Method 2026
- Polarity: Indicated by cathode band
- Standard packaging: 16mm tape (EIA-481)
- Weight: 0.007 ounce, 0.21 gram

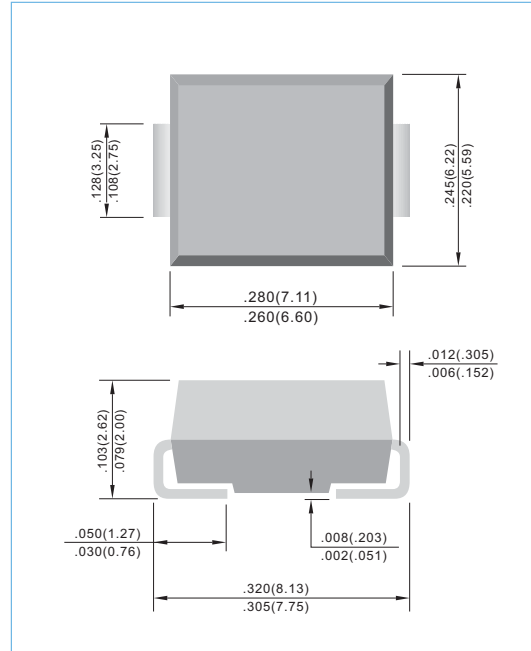

### MAXIMUM RATINGS AND ELECTRICAL CHARACTERISTICS

Ratings at 25°C ambient temperature unless otherwise specified. Single phase , half wave ,60Hz, resistive or inductive load. For capacitive load , derate current by 20%.

PARAMETER	SYMBOL	S3A	S3B	S3D	S3G	S3J	S3K	S3M	UNITS
Maximum Recurrent Peak Reverse Voltage	$V_{RRM}$	50	100	200	400	600	800	1000	V
Maximum RMS Voltage	$V_{RMS}$	35	70	140	280	420	560	700	V
Maximum DC Blocking Voltage	$V_{DC}$	50	100	200	400	600	800	1000	V
Maximum Average Forward Rectified Current at $T_L = 75^\circ\text{C}$	$I_{F(AV)}$	3.0							A
Peak Forward Surge Current :8.3ms single half sine-wave superimposed on rated load(JEDEC method)	$I_{FSM}$	100							A
Maximum Forward Voltage at 3.0A	$V_F$	1.2							V
Maximum DC Reverse Current at $T_J = 25^\circ\text{C}$ Rated DC Blocking Voltage $T_J = 125^\circ\text{C}$	$I_R$	5.0 250							uA
Maximum Junction capacitance (Note 1)	$C_J$	53							pF
Typical Junction Resistance(Note 2)	$R_{\theta JL}$ $R_{\theta JA}$	13 47							$^\circ\text{C} / \text{W}$
Operating Junction and Storage Temperature Range	$T_J, T_{STG}$	-55 TO +150							$^\circ\text{C}$

**NOTES:**

1. Measured at 1.0 MHZ and applied Vr=4.0 volts.
2. 8.0mm<sup>2</sup>(.013mm thick)land areas.



# S3A~S3M

## RATING AND CHARACTERISTIC CURVES

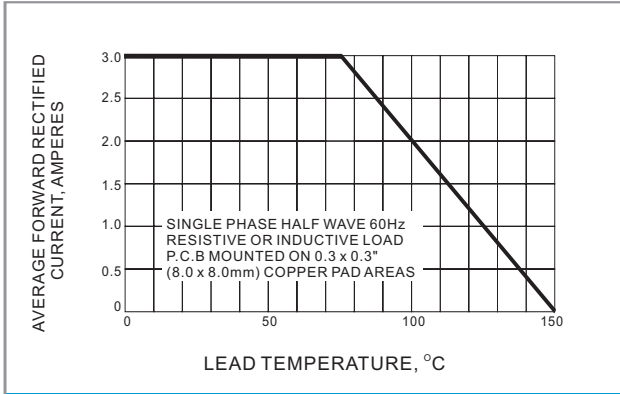

**Fig.1 FORWARD CURRENT DERATING CURVE**

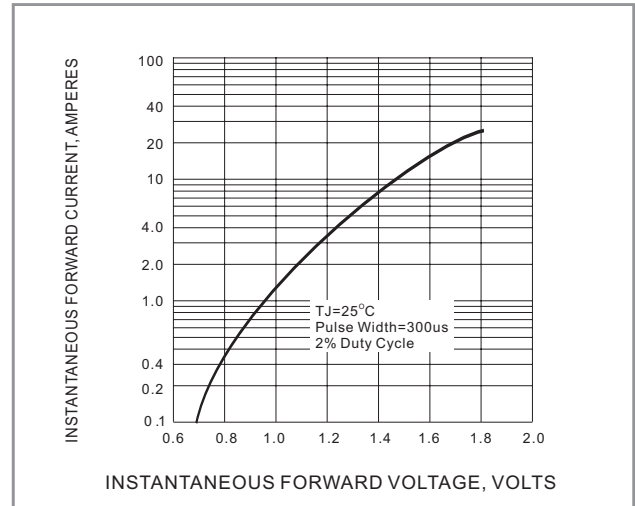

**Fig.2 TYPICAL INSTANTANEOUS FORWARD CHARACTERISTICS**

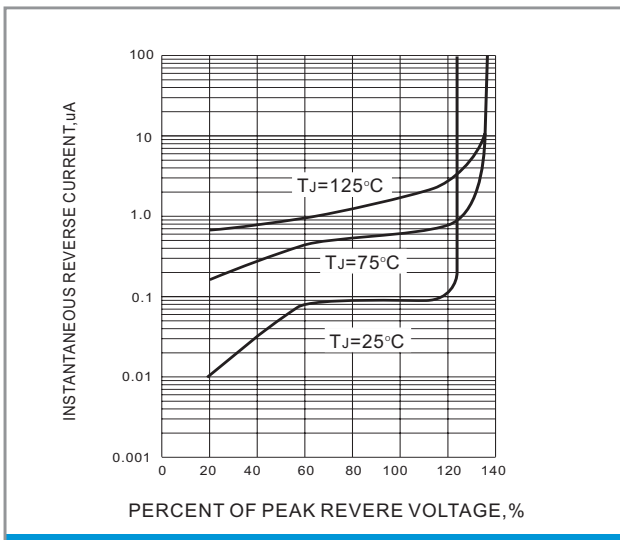

**Fig.3 TYPICAL REVERSE CHARACTERISTICS**

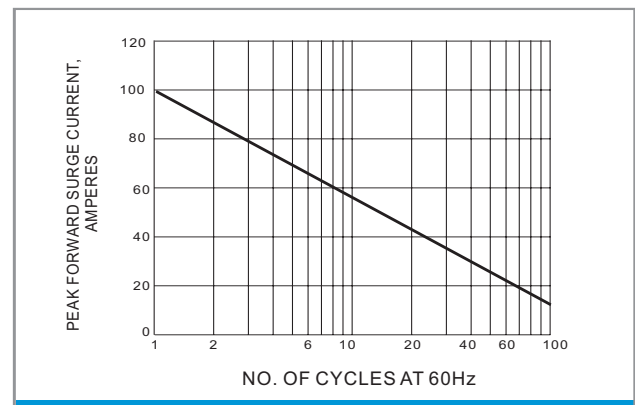

**Fig.4 MAXIMUM NON REPETITIVE PEAK SURGE CURRENT**

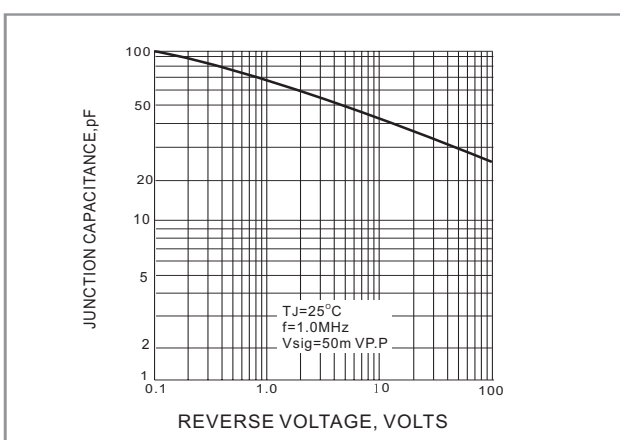

**Fig.5 TYPICAL JUNCTION CAPACITANCE**



## S3A~S3M

### MOUNTING PAD LAYOUT

SMC/DO-214AB

Unit: inch ( mm )

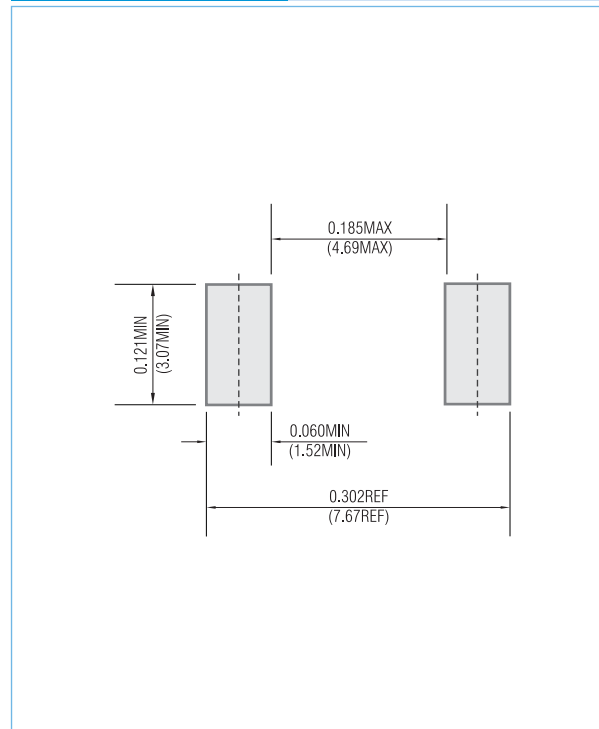

### ORDER INFORMATION

- Packing information
  - T/R - 3K per 13" plastic Reel
  - T/R - 0.5Kper 7" plastic Reel

### LEGAL STATEMENT

#### Copyright PanJit International, Inc 2007

The information presented in this document is believed to be accurate and reliable. The specifications and information herein are subject to change without notice. Pan Jit makes no warranty, representation or guarantee regarding the suitability of its products for any particular purpose. Pan Jit products are not authorized for use in life support devices or systems. Pan Jit does not convey any license under its patent rights or rights of others.