

NTMS4503N

Power MOSFET

28 V, 14 A, N-Channel, SO-8

Features

- Low RDS(on)
- High Power and Current Handling Capability
- Low Gate Charge

Applications

- DC/DC Converters
- Motor Drives
- Synchronous Rectifier – POL
- Buck Low-Side

MAXIMUM RATINGS (T_J = 25°C unless otherwise noted)

Rating	Symbol	Value	Unit
Drain-to-Source Voltage	V _{DSS}	28	V
Gate-to-Source Voltage – Continuous	V _{GS}	±20	V
Drain Current	I _D	14	A
Continuous @ T _a = 25°C (Note 1)		12	
Continuous @ T _a = 25°C (Note 2)		9.0	
Continuous @ T _a = 25°C (Note 3)		40	
Single Pulse (tp = 10 μs)	I _{DM}		
Total Power Dissipation	P _D	2.5	W
T _A = 25°C (Note 1)		1.66	
T _A = 25°C (Note 2)		0.93	
T _A = 25°C (Note 3)			
Operating and Storage Temperature	T _J , T _{stg}	-55 to 150	°C
Single Pulse Drain-to-Source Avalanche Energy – Starting T _J = 25°C (V _{DD} = 30 V, V _{GS} = 10 V, I _L = 12.2 A, L = 1.0 mH, R _G = 25 Ω)	E _{AS}	75	mJ
Maximum Lead Temperature for Soldering Purposes, 1/8" from case for 10 seconds	T _L	260	°C

THERMAL RESISTANCE RATINGS

Rating	Symbol	Value	Unit
Thermal Resistance	R _{θJA}	50	°C/W
Junction-to-Ambient (Note 1)		75	
Junction-to-Ambient (Note 2)		135	
Junction-to-Ambient (Note 3)			

1. Surface-mounted on FR4 board using minimum recommended pad size (Cu area 0.412 in²), t < 10 s.
2. Surface-mounted on FR4 board using 1" pad size (Cu area 1.127 in²) steady state.
3. Surface-mounted on FR4 board using minimum recommended pad size (Cu area 0.412 in²), steady state.



ON Semiconductor®

<http://onsemi.com>

V _{(BR)DSS}	R _{DS(on)} TYP	I _D MAX (Note 1)
28 V	7.0 mΩ @ 10 V	14 A
	8.8 mΩ @ 4.5 V	

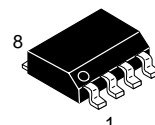
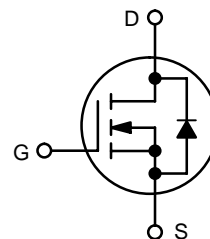

SO-8
CASE 751
STYLE 12

MARKING DIAGRAM/ PIN ASSIGNMENT

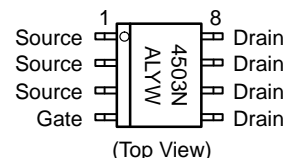

4503N = Specific Device Code
 A = Assembly Location
 L = Wafer Lot
 Y = Year
 W = Work Week

ORDERING INFORMATION

Device	Package	Shipping†
NTMS4503NR2	SO-8	2500/Tape & Reel

†For information on tape and reel specifications, including part orientation and tape sizes, please refer to our Tape and Reel Packaging Specifications Brochure, BRD8011/D.

NTMS4503N

ELECTRICAL CHARACTERISTICS (T_J = 25°C unless otherwise noted)

Characteristic	Symbol	Test Condition	Min	Typ	Max	Unit
----------------	--------	----------------	-----	-----	-----	------

OFF CHARACTERISTICS

Drain-to-Source Breakdown Voltage	V _{(BR)DSS}	V _{GS} = 0 V, I _D = 250 μA	28	31	–	V	
Drain-to-Source Breakdown Voltage Temperature Coefficient	V _{(BR)DSS} /T _J	–	–	22	–	mV/°C	
Zero Gate Voltage Drain Current	I _{DSS}	V _{GS} = 0 V, V _{DS} = 24 V	T _J = 25°C	–	–	1.0	μA
			T _J = 100°C	–	–	25	
Gate-to-Source Leakage Current	I _{GSS}	V _{DS} = 0 V, V _{GS} = ±20 V	–	–	±100	nA	

ON CHARACTERISTICS (Note 4)

Gate Threshold Voltage	V _{GS(TH)}	V _{GS} = V _{DS} , I _D = 250 μA	1.0	–	2.0	V
Negative Threshold Temperature Coefficient	V _{GS(TH)} /T _J	–	–	–5.0	–	mV/°C
Drain-to-Source On Resistance	R _{DS(on)}	V _{GS} = 10 V, I _D = 14 A	–	7.0	8.0	mΩ
		V _{GS} = 4.5 V, I _D = 10 A	–	8.8	9.8	
Forward Transconductance	g _{FS}	V _{DS} = 10 V, I _D = 14 A	–	30	–	S

CHARGES, CAPACITANCES AND GATE RESISTANCE

Input Capacitance	C _{ISS}	V _{GS} = 0 V, f = 1.0 MHz, V _{DS} = 16 A	–	2400	–	pF
Output Capacitance	C _{OSS}		–	1000	–	
Reverse Transfer Capacitance	C _{RSS}		–	375	–	
Total Gate Charge	Q _{G(TOT)}	V _{GS} = 4.5 V, V _{DS} = 16 V, I _D = 10 A	–	23	–	nC
Threshold Gate Charge	Q _{G(TH)}		–	2.0	–	
Gate-to-Source Charge	Q _{GS}		–	5.0	–	
Gate-to-Drain Charge	Q _{GD}		–	12	–	

SWITCHING CHARACTERISTICS, V_{GS} = V (Note 5)

Turn-On Delay Time	t _{d(ON)}	V _{GS} = 4.5 V, V _{DD} = 16 V, I _D = 10 A, R _G = 2.0 Ω	–	18.5	–	ns
Rise Time	t _r		–	70	–	
Turn-Off Delay Time	t _{d(OFF)}		–	21	–	
Fall Time	t _f		–	23	–	

DRAIN-SOURCE DIODE CHARACTERISTICS

Forward Diode Voltage	V _{SD}	V _{GS} = 0 V, I _S = 10 A	T _J = 25°C	–	0.82	1.2	V
			T _J = 125°C	–	0.65	–	
Reverse Recovery Time	t _{RR}	V _{GS} = 0 V, dI _{SD} /dt = 100 A/μs, I _S = 14 A	–	48	–	ns	
Charge Time	T _a		–	23	–		
Discharge Time	T _b		–	25	–		
Reverse Recovery Charge	Q _{RR}		–	25	–	nC	

4. Pulse Test: Pulse Width ≤ 300 μs, Duty Cycle ≤ 2%.
 5. Switching characteristics are independent of operating junction temperatures.

TYPICAL PERFORMANCE CURVES

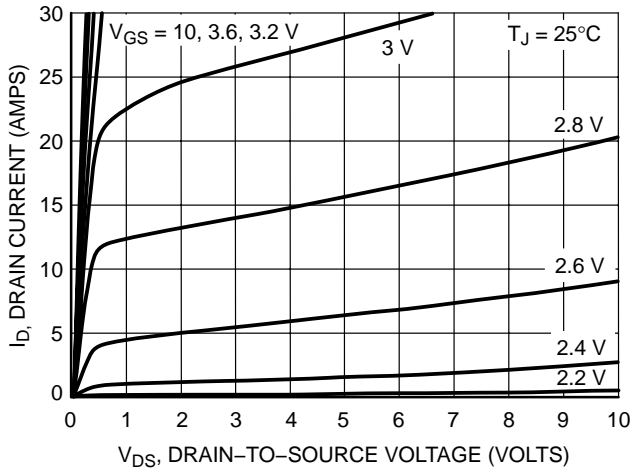

Figure 1. On-Region Characteristics

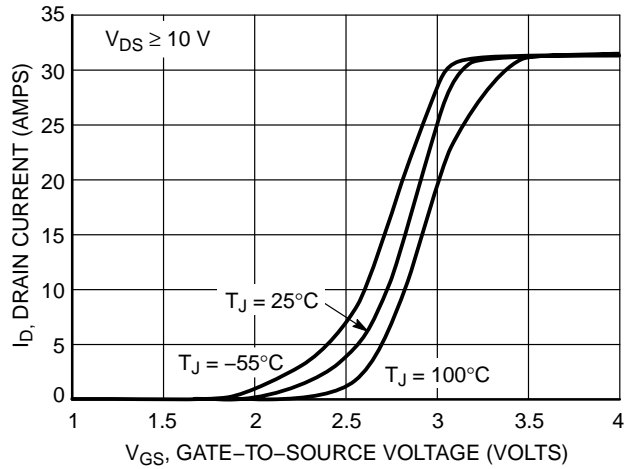

Figure 2. Transfer Characteristics

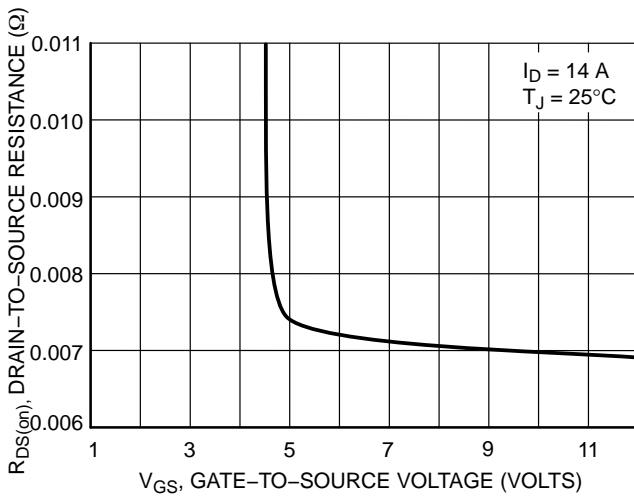

Figure 3. On-Resistance vs. Gate-to-Source Voltage

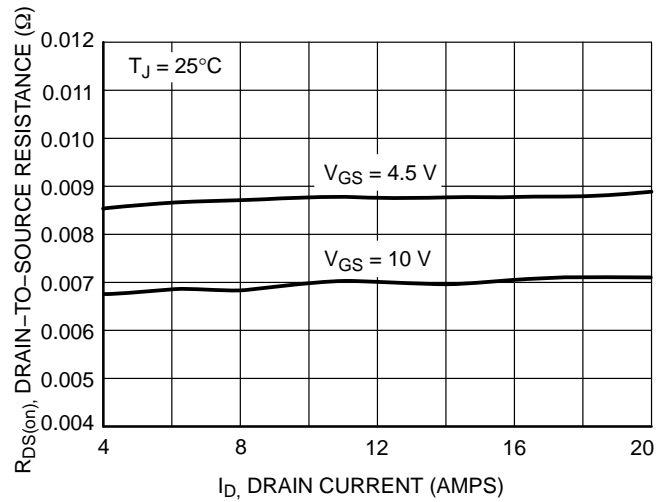

Figure 4. On-Resistance vs. Drain Current and Gate Voltage

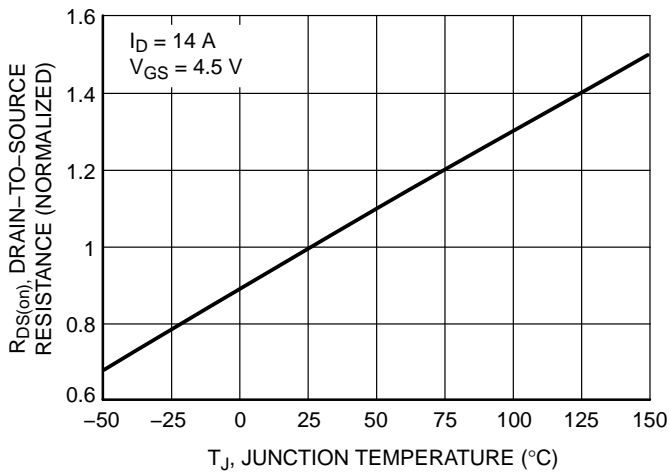

Figure 5. On-Resistance Variation with Temperature

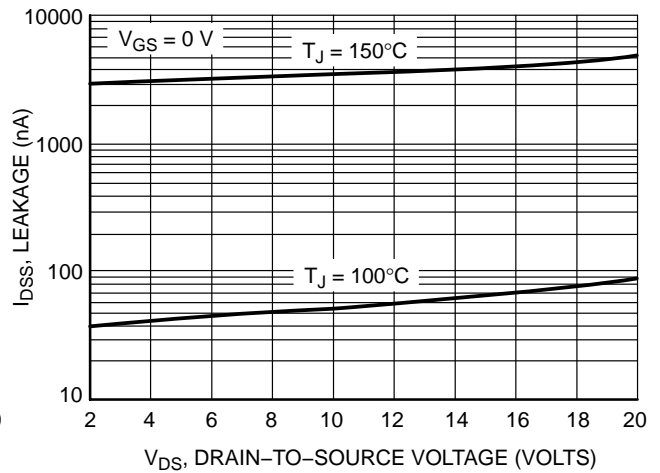

Figure 6. Drain-to-Source Leakage Current vs. Voltage

TYPICAL PERFORMANCE CURVES

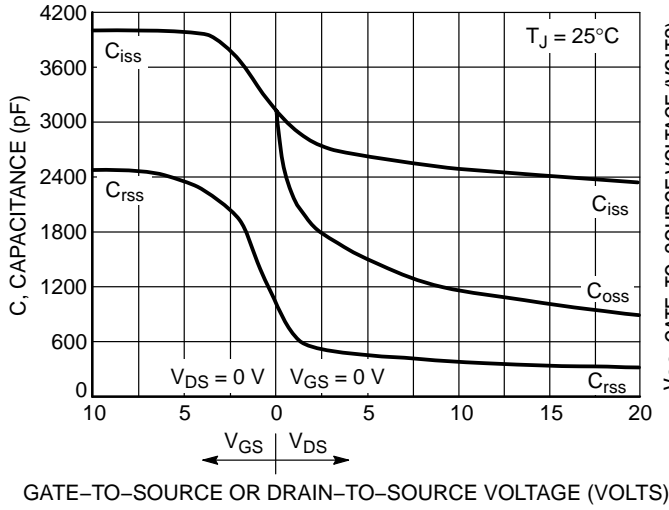

Figure 7. Capacitance Variation

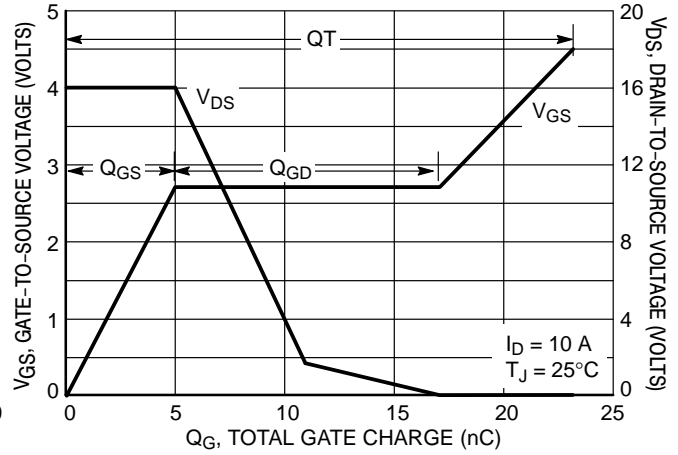

Figure 8. Gate-To-Source and Drain-To-Source Voltage vs. Total Charge

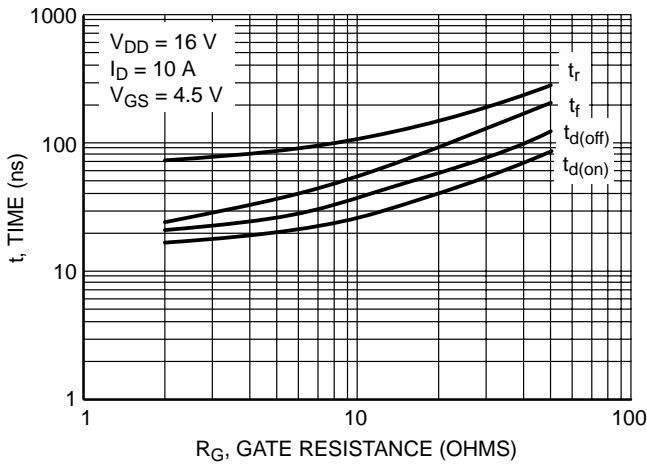

Figure 9. Resistive Switching Time Variation vs. Gate Resistance

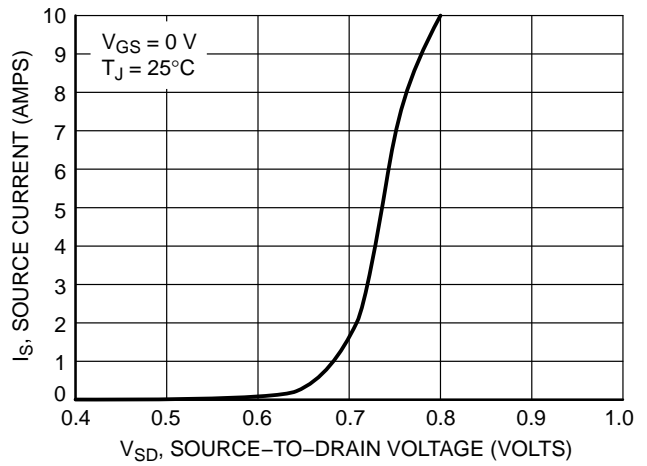
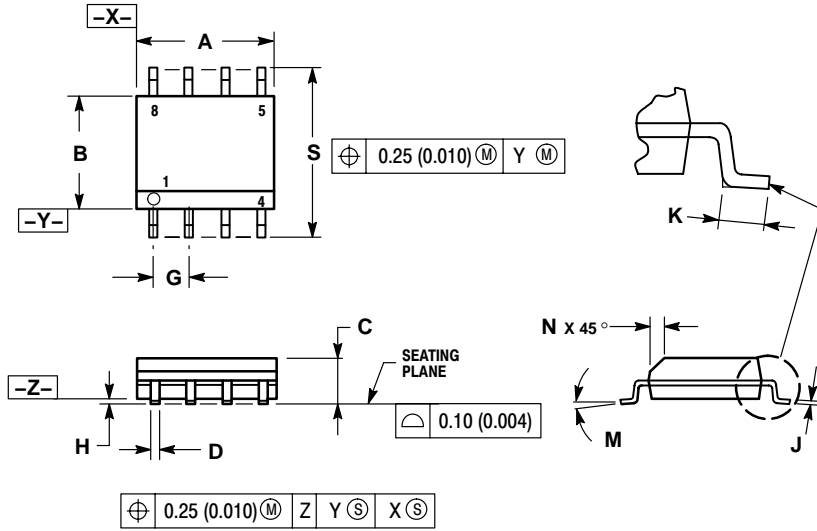

Figure 10. Diode Forward Voltage vs. Current

NTMS4503N

PACKAGE DIMENSIONS

SO-8
CASE 751-07
ISSUE AA



NOTES:

1. DIMENSIONING AND TOLERANCING PER ANSI Y14.5M, 1982.
2. CONTROLLING DIMENSION: MILLIMETER.
3. DIMENSION A AND B DO NOT INCLUDE MOLD PROTRUSION.
4. MAXIMUM MOLD PROTRUSION 0.15 (0.006) PER SIDE.
5. DIMENSION D DOES NOT INCLUDE DAMBAR PROTRUSION. ALLOWABLE DAMBAR PROTRUSION SHALL BE 0.127 (0.005) TOTAL IN EXCESS OF THE D DIMENSION AT MAXIMUM MATERIAL CONDITION.
6. 751-01 THRU 751-06 ARE OBSOLETE. NEW STANDARD IS 751-07.

DIM	MILLIMETERS		INCHES	
	MIN	MAX	MIN	MAX
A	4.80	5.00	0.189	0.197
B	3.80	4.00	0.150	0.157
C	1.35	1.75	0.053	0.069
D	0.33	0.51	0.013	0.020
G	1.27 BSC		0.050 BSC	
H	0.10	0.25	0.004	0.010
J	0.19	0.25	0.007	0.010
K	0.40	1.27	0.016	0.050
M	0°	8°	0°	8°
N	0.25	0.50	0.010	0.020
S	5.80	6.20	0.228	0.244

STYLE 12:

- PIN 1. SOURCE
 2. SOURCE
 3. SOURCE
 4. GATE
 5. DRAIN
 6. DRAIN
 7. DRAIN
 8. DRAIN

NTMS4503N

ON Semiconductor and  are registered trademarks of Semiconductor Components Industries, LLC (SCILLC). SCILLC reserves the right to make changes without further notice to any products herein. SCILLC makes no warranty, representation or guarantee regarding the suitability of its products for any particular purpose, nor does SCILLC assume any liability arising out of the application or use of any product or circuit, and specifically disclaims any and all liability, including without limitation special, consequential or incidental damages. "Typical" parameters which may be provided in SCILLC data sheets and/or specifications can and do vary in different applications and actual performance may vary over time. All operating parameters, including "Typicals" must be validated for each customer application by customer's technical experts. SCILLC does not convey any license under its patent rights nor the rights of others. SCILLC products are not designed, intended, or authorized for use as components in systems intended for surgical implant into the body, or other applications intended to support or sustain life, or for any other application in which the failure of the SCILLC product could create a situation where personal injury or death may occur. Should Buyer purchase or use SCILLC products for any such unintended or unauthorized application, Buyer shall indemnify and hold SCILLC and its officers, employees, subsidiaries, affiliates, and distributors harmless against all claims, costs, damages, and expenses, and reasonable attorney fees arising out of, directly or indirectly, any claim of personal injury or death associated with such unintended or unauthorized use, even if such claim alleges that SCILLC was negligent regarding the design or manufacture of the part. SCILLC is an Equal Opportunity/Affirmative Action Employer. This literature is subject to all applicable copyright laws and is not for resale in any manner.

PUBLICATION ORDERING INFORMATION

LITERATURE FULFILLMENT:

Literature Distribution Center for ON Semiconductor
P.O. Box 5163, Denver, Colorado 80217 USA

Phone: 303-675-2175 or 800-344-3860 Toll Free USA/Canada

Fax: 303-675-2176 or 800-344-3867 Toll Free USA/Canada

Email: orderlit@onsemi.com

N. American Technical Support: 800-282-9855 Toll Free
USA/Canada

Japan: ON Semiconductor, Japan Customer Focus Center
2-9-1 Kamimeguro, Meguro-ku, Tokyo, Japan 153-0051
Phone: 81-3-5773-3850

ON Semiconductor Website: <http://onsemi.com>

Order Literature: <http://www.onsemi.com/litorder>

For additional information, please contact your
local Sales Representative.

NTMS4503N/D