

GaAs MMIC SMT HIGH ISOLATION SPDT SWITCH, DC - 6.0 GHz

Typical Applications

The HMC607G7 is ideal for:

- Telecom Infrastructure
- Microwave Radio & VSAT
- Military Radios, Radar & ECM
- Space Systems
- Test Instrumentation

Functional Diagram

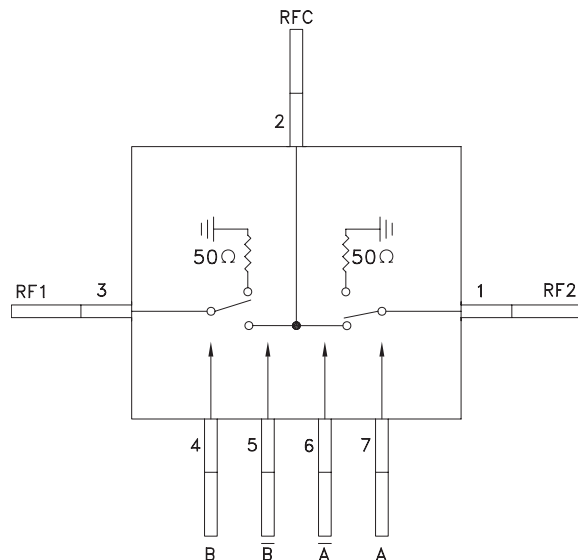

Features

- High Isolation: 55 dB @ 2.0 GHz
42 dB @ 6.0 GHz
- Low Insertion Loss: 1.9 dB Typical @ 6.0 GHz
- Non-Reflective Design
- Hermetic Surface Mount Package
- Higher Performance Drop-In Replacement for:
Skyworks AS406M2-10

General Description

The HMC607G7 is a broadband high isolation non-reflective GaAs MESFET SPDT switch in a hermetic surface mount package. Covering DC to 6.0 GHz, the switch features >55 dB isolation up to 2 GHz and >42 dB isolation up to 6.0 GHz. The switch operates using complementary negative control voltage logic lines of -5/0V and requires no bias supply.

Electrical Specifications, $T_A = +25^\circ \text{C}$, With 0/-5V Control, 50 Ohm System

Parameter	Frequency	Min.	Typ.	Max.	Units
Insertion Loss	DC - 2.0 GHz		1.3	1.6	dB
	DC - 4.0 GHz		1.4	1.7	dB
	DC - 6.0 GHz		1.9	2.3	dB
Isolation	DC - 2.0 GHz	50	55		dB
	DC - 4.0 GHz	41	46		dB
	DC - 6.0 GHz	37	42		dB
Return Loss	DC - 2.0 GHz		20		dB
	DC - 4.0 GHz		17		dB
	DC - 6.0 GHz		13		dB
Return Loss RF1, RF2	DC - 2.0 GHz		13		dB
	DC - 4.0 GHz		13		dB
	DC - 6.0 GHz		13		dB
Input Power for 1 dB Compression	0.5 - 6.0 GHz	23	27		dBm
Input Third Order Intercept (Two-Tone Input Power= +7 dBm Each Tone, 1 MHz Tone Separation)	0.5 - 6.0 GHz		47		dBm
Switching Characteristics	DC - 6.0 GHz	tRISE, tFALL (10/90% RF)	3		ns
		tON, tOFF (50% CTL to 10/90% RF)	6		ns

For price, delivery, and to place orders, please contact Hittite Microwave Corporation:
20 Alpha Road, Chelmsford, MA 01824 Phone: 978-250-3343 Fax: 978-250-3373
Order On-line at www.hittite.com

**GaAs MMIC SMT HIGH ISOLATION
SPDT SWITCH, DC - 6.0 GHz**

Insertion Loss

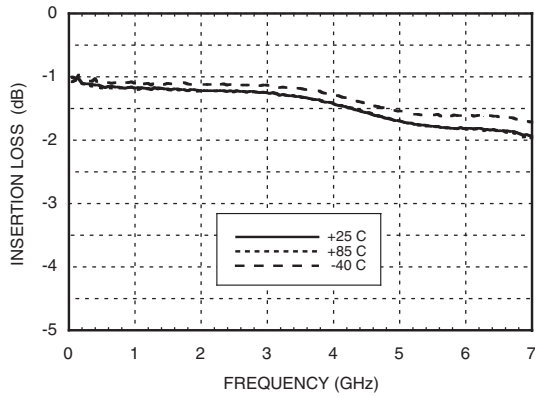

Isolation

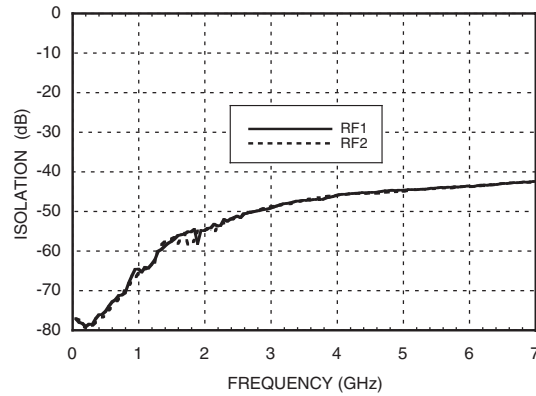

Return Loss

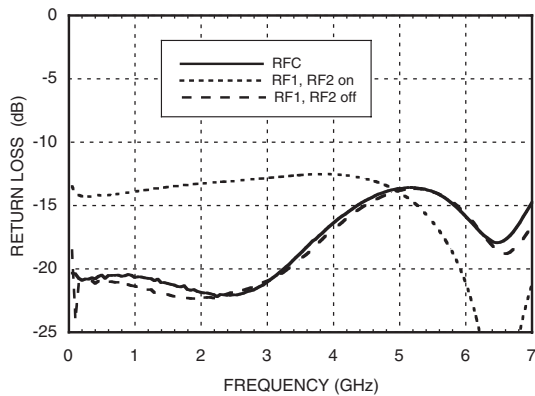

0.1 and 1 dB Input Compression Point

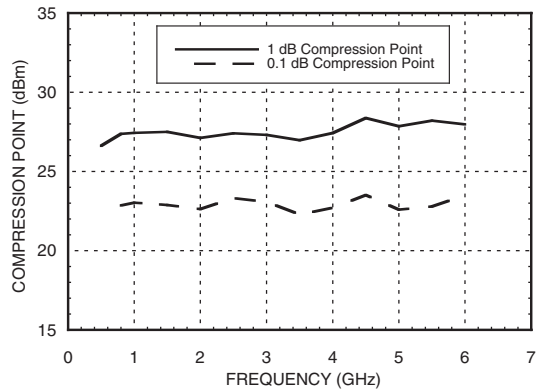

Input Third Order Intercept Point

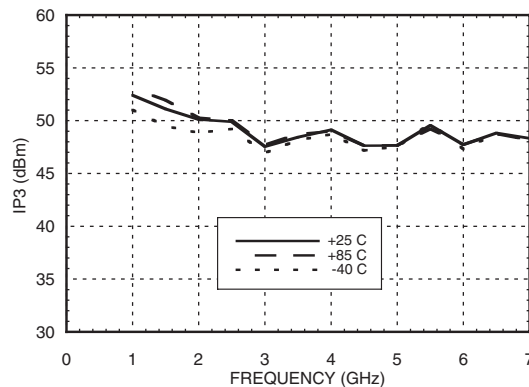

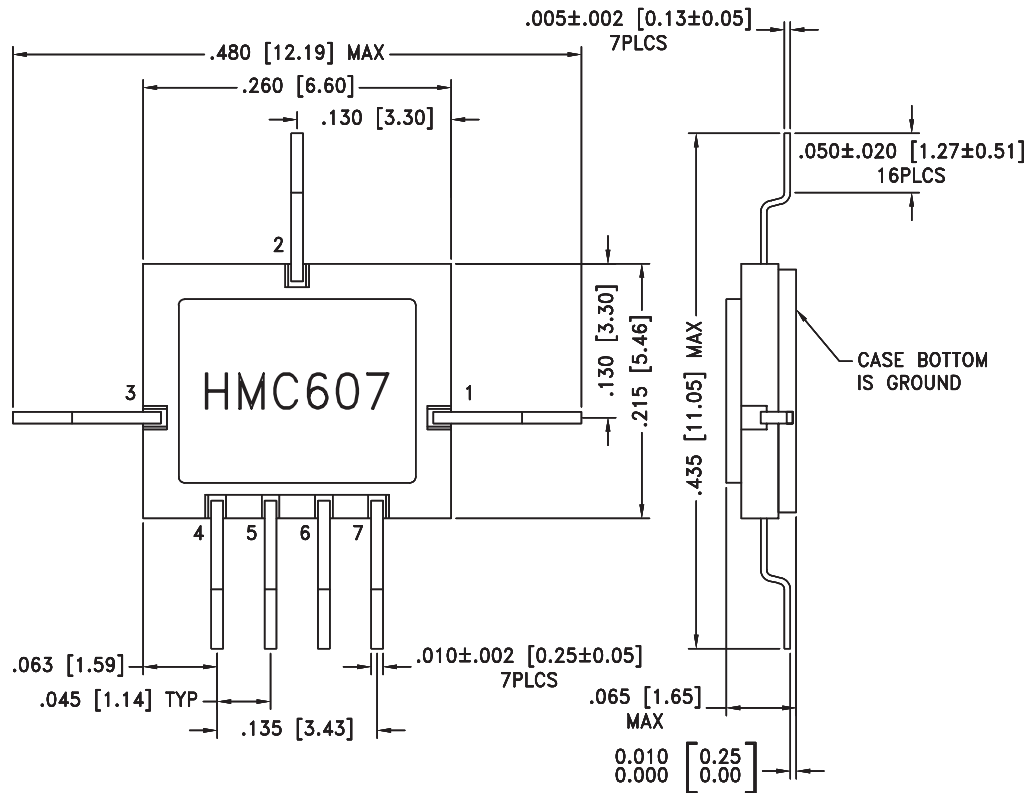

**GaAs MMIC SMT HIGH ISOLATION
SPDT SWITCH, DC - 6.0 GHz**

Outline Drawing

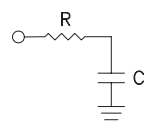

- NOTES:
1. PACKAGE BODY MATERIAL: WHITE ALUMINA 92%
 2. CONDUCTOR TRACES MATERIAL: THICK FILM TUNGSTEN.
 3. LEAD, BASE, COVER MATERIAL: KOVAR™.
 4. PLATING: ELECTROLYTIC GOLD 50 MICROINCHES MIN, OVER ELECTROLYTIC NICKEL 50 MICROINCHES MIN.
 5. ALL DIMENSIONS ARE IN INCHES [MILLIMETERS].
 6. TOLERANCES: ±.005 [0.13] UNLESS OTHERWISE SPECIFIED.
 7. ALL GROUND LEADS AND GROUND PADDLE MUST BE SOLDERED TO PCB RF GROUND.

Pin Descriptions

Pin Number	Function	Description	Interface Schematic
1, 2, 3	RF2, RFC, RF1	This pin is DC coupled and matched to 50 Ohm. Blocking capacitors are required if RF line potential is not equal to 0V.	
4	B	See truth table and control voltage table.	
5	\bar{B}		
6	\bar{A}		
7	A		
	GND	Package bottom must also be connected to PCB RF ground.	

**GaAs MMIC SMT HIGH ISOLATION
SPDT SWITCH, DC - 6.0 GHz**

Evaluation PCB

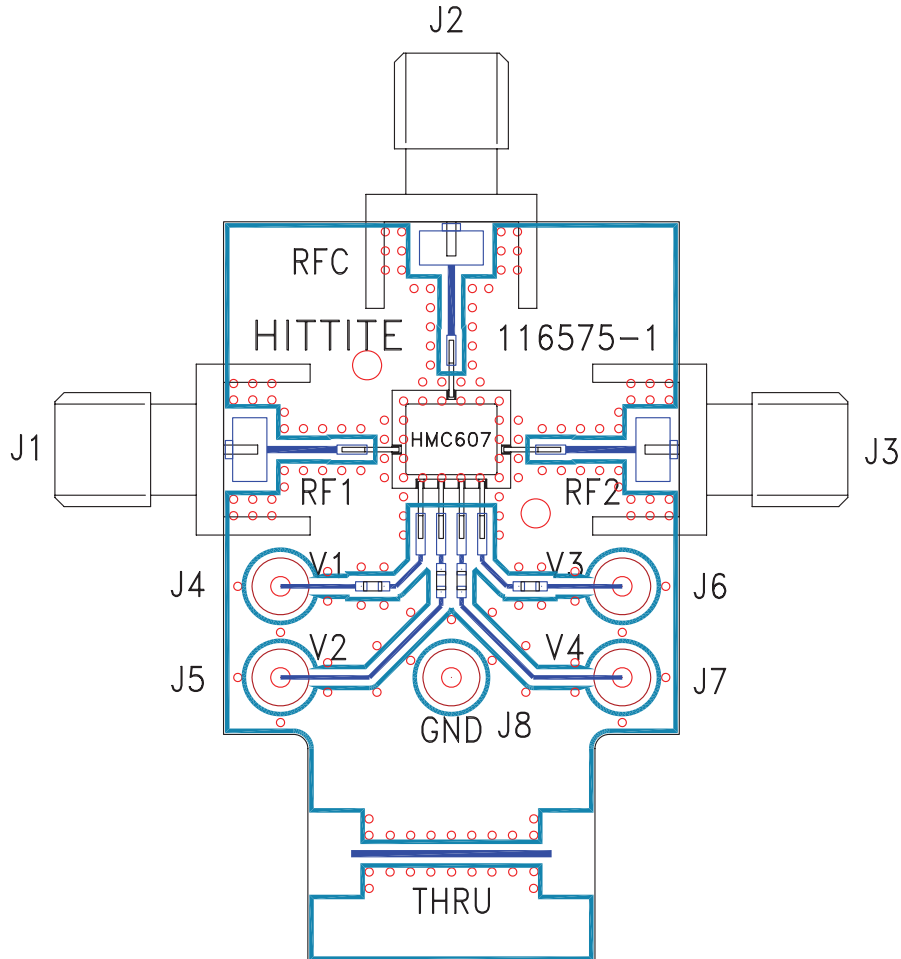

List of Materials for Evaluation PCB 116577 [1]

Item	Description
J1 - J3	PCB Mount SMA RF Connector
J4 - J8	DC Pin
R1 - R4	100 Ohm Resistor, 0402 Pkg.
U1	HMC607G7 SPDT Switch
PCB [2]	116575 Evaluation PCB

[1] Reference this number when ordering complete evaluation PCB

[2] Circuit Board Material: Rogers 4350

The circuit board used in the final application should be generated with proper RF circuit design techniques. Signal lines at the RF port should have 50 ohm impedance and the package ground leads and package bottom should be connected directly to the ground plane similar to that shown above. The evaluation circuit board shown above is available from Hittite Microwave Corporation upon request.

**GaAs MMIC SMT HIGH ISOLATION
SPDT SWITCH, DC - 6.0 GHz**

Notes: