

Features

- Micropower operation
- Operation with North or South Pole
- 1.65 to 3.3V battery operation
- Chopper stabilized
 - Superior temperature stability
 - Extremely Low Switch-Point Drift
 - Insensitive to Physical Stress
- Good RF noise immunity
- -40°C to 85°C operating temperature
- ESD > 4KV in human body mode
- SOT553: Available in "Green" Molding Compound (no Br, Sb)
- Lead Free Finish/RoHS Compliant (Note 1)

General Description

AH1883 is with two Hall effect plates and a CMOS output driver, mainly designed for battery-powered, hand-held equipment (such as Cellular and Cordless Phone, PDA). The total operation power is down to 15uW in the 1.8V supply.

Either north or south pole of sufficient strength will turn the output on. The output will be turned off under no magnetic field. While the magnetic flux density (**B**) is larger than operate point (**Bop**), the output will be turned on (low), the output is held until **B** is lower than release point (**Brp**), then turned off.

Applications

- Cellular phone
- PDA
- Cordless phone

Ordering Information

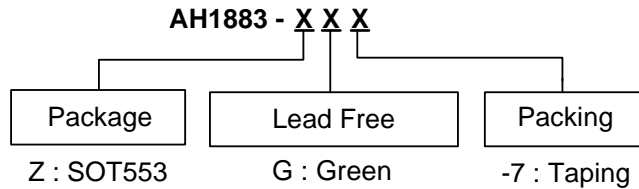

Note: 1. RoHS revision 13.2.2003. Glass and High Temperature Solder Exemptions Applied, see *EU Directive Annex Notes 5 and 7*.

Device	Package Code	Packaging (Note 2)	7" Tape and Reel	
			Quantity	Part Number Suffix
AH1883-Z	Z	SOT553	3000/Tape & Reel	-7

Note: 2. Pad layout as shown on Diodes Inc. suggested pad layout document AP02001, which can be found on our website at <http://www.diodes.com/datasheets/ap02001.pdf>.

Pin Assignment

(Top View)

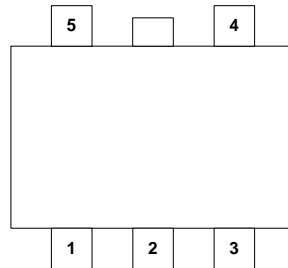

SOT553

Pin Descriptions

Name	P/I/O	Pin #	Description
N.C.		1	No Connection
GND	P/I	2	Ground
N.C.		3	No Connection
Vdd	P/I	4	Power Supply Voltage
Output	O	5	Output Pin (active Low)

Block Diagram

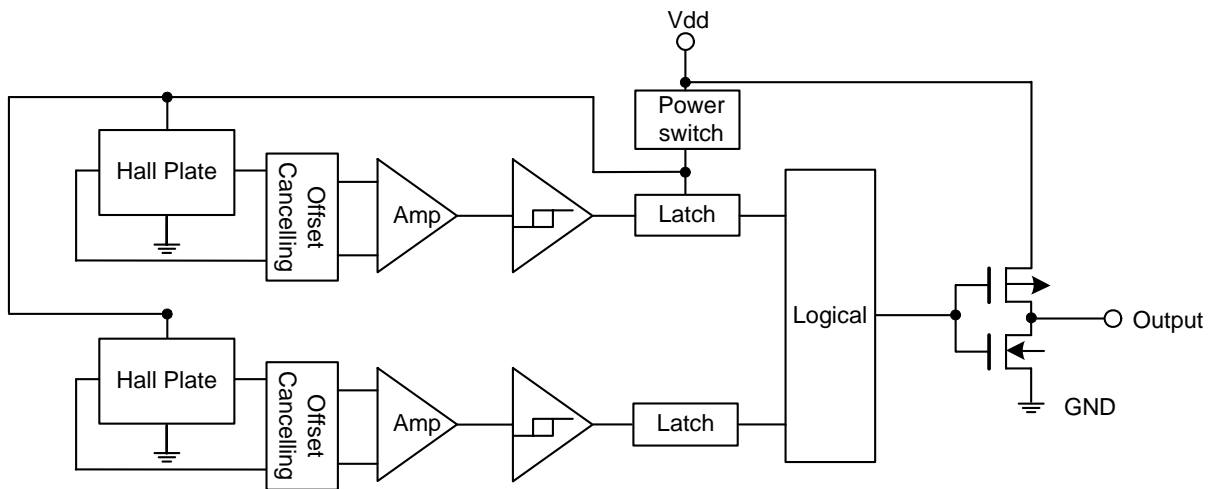

Typical Circuit

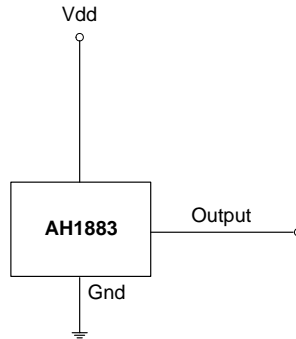

Absolute Maximum Ratings (at TA= 25°C)

Symbol	Characteristics	Values	Unit
Vdd	Supply voltage	5	V
B	Magnetic flux density	Unlimited	
TA	Operating Temperature Range	-40 to +85	°C
Ts	Storage Temperature Range	-65 to +150	°C
PD	Package Power Dissipation	230	mW
TJ	Maximum Junction Temperature	150	°C

Recommended Operating Conditions (TA = 25°C)

Symbol	Parameter	Conditions	Rating	Unit
Vdd	Supply Voltage	Operating	1.65~3.3	V

Electrical Characteristics (TA = +25°C, Vdd = 1.8V; unless otherwise specified)

Symbol	Characteristic	Conditions	Min	Typ	Max	Unit
V _{OH}	Output On Voltage (High side)	I _O = -0.5mA	Vdd-0.2	-	-	V
V _{OL}	Output On Voltage (Low side)	I _O = 0.5mA	-	-	0.2	V
I _{off}	Output Leakage Current	Output off	-	<0.1	1	µA
I _{dd(en)}	Supply Current	Chip enable	-	2	4	mA
I _{dd(dis)}		Chip disable	-	5	8	µA
I _{dd(avg)}		average supply current	-	7	12	µA
T _{awake}	Awake Time		-	50	100	µs
T _{period}	Period		-	50	100	ms
D.C.	Duty Cycle		-	0.1	-	%

Magnetic Characteristics ($T_A = 25^\circ\text{C}$, $V_{dd} = 1.8\text{V} \sim 3.0\text{V}$) (Note 3)

(1mT=10 Gauss)

Symbol	Characteristic (Note 4)	Min	Typ	Max	Unit
Bops(south pole to brand side)	Operate Point	-	37	55	Gauss
Bopn(north pole to brand side)		-55	-37	-	
Brps(south pole to brand side)	Release Point	6	29	-	
Brpn(north pole to brand side)		-	-29	-6	
Bhy($ B_{opx} - B_{rpx} $)	Hysteresis	3	8	-	

Notes: 3. Typical data is at $T_A = 25^\circ\text{C}$, $V_{dd} = 3\text{V}$, and for design information only.
4. Operate point and release point will vary with supply voltage and operating temperature.

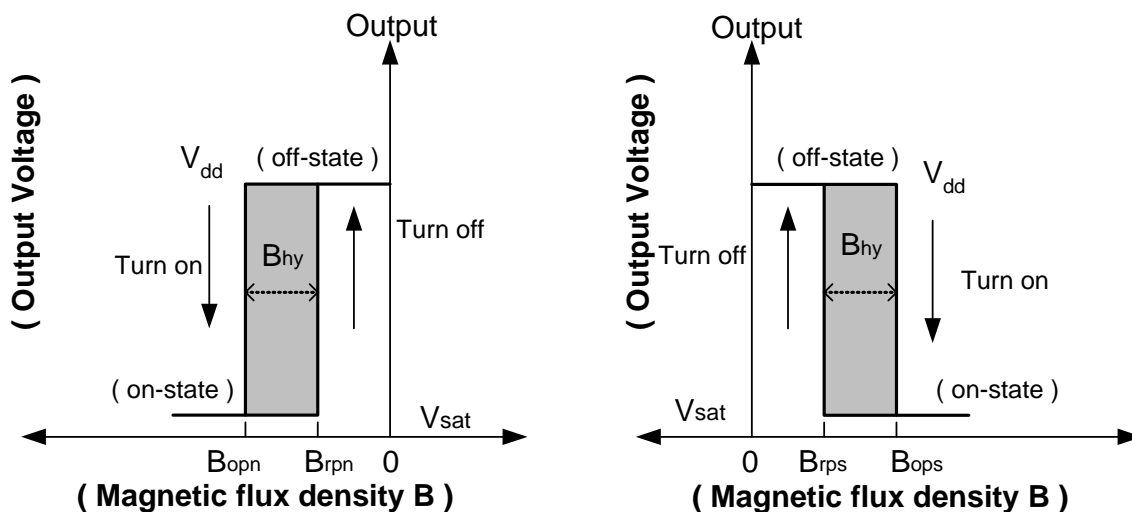

Typical Operating Characteristics

Switching Point

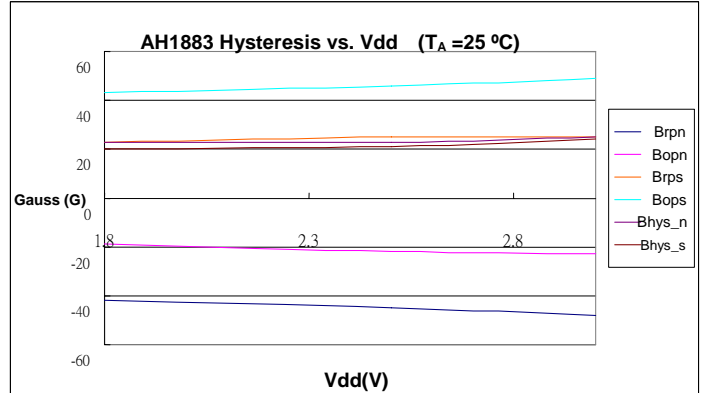
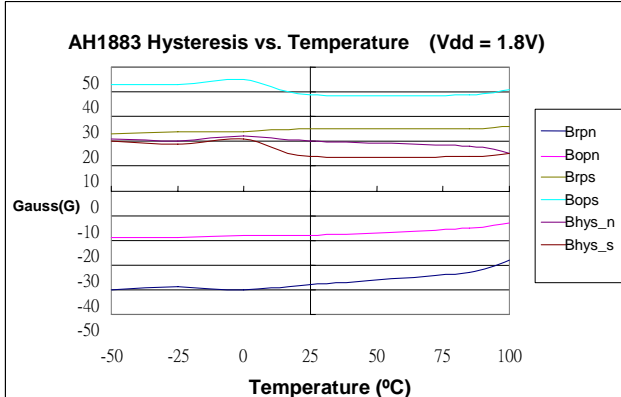

Supply Current

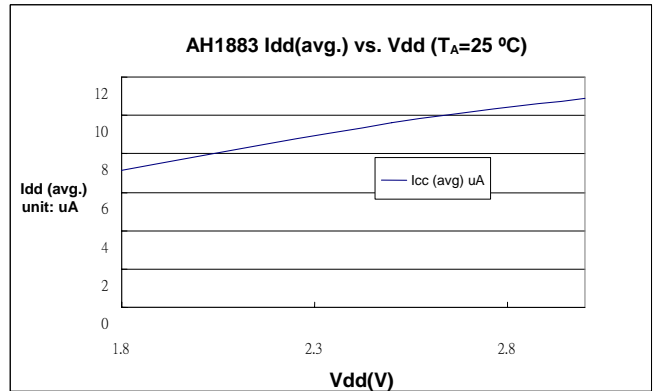
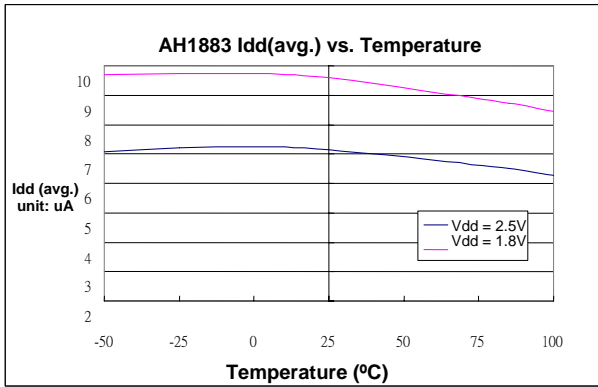

Performance Characteristics

T _A (°C)	25	50	60	70	80	85	90	100	110	120	130	140	150
P _D (mW)	230	184	166	147	129	120	110	92	74	55	37	18	0

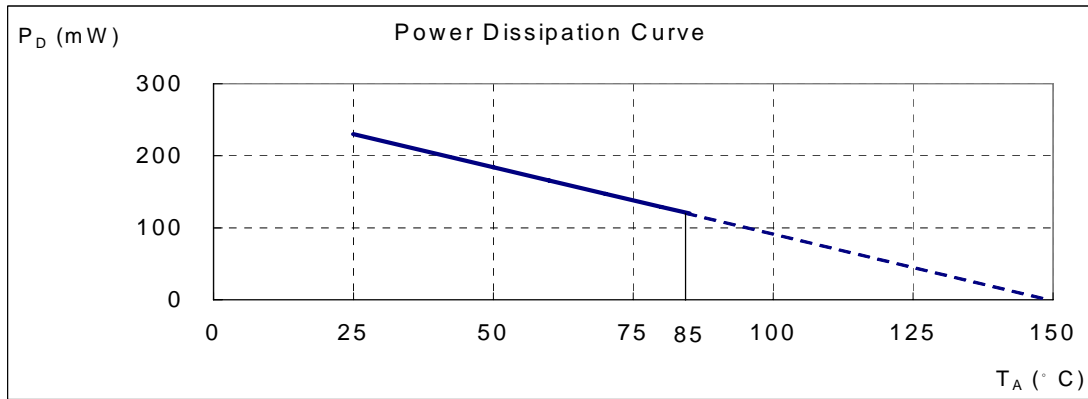

Marking Information

(1) SOT553

(Top View)

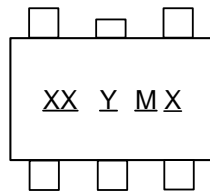

XX : KP : AH1883
Y : Year 0~9
M : Month A~L
X : Internal code
 A~Z : Green

Part Number	Package	Identification Code
AH1883	SOT553	KP

Package Information (unit: mm)

(1) Package Type: SOT553

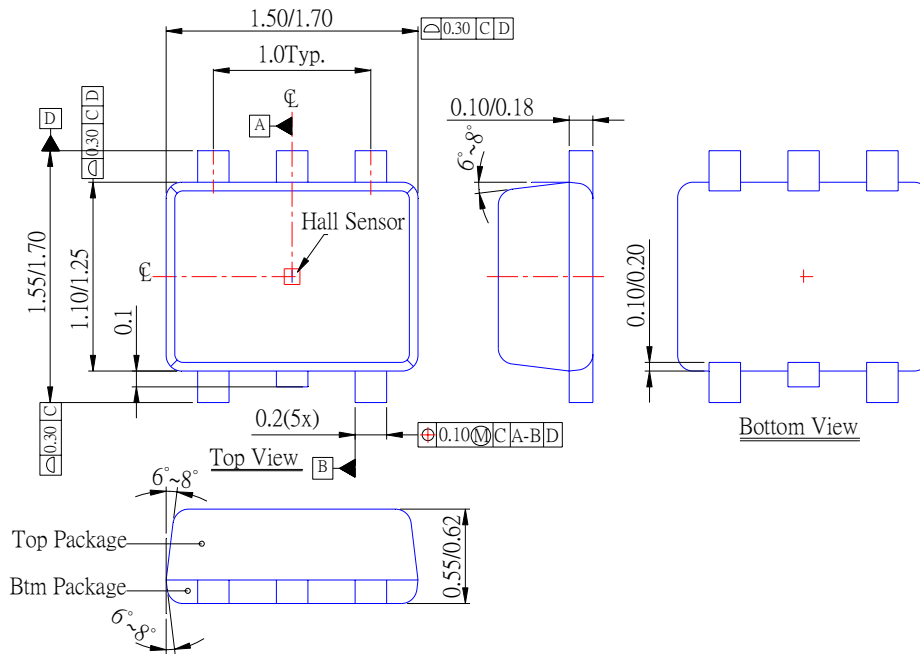

IMPORTANT NOTICE

Diodes Incorporated and its subsidiaries reserve the right to make modifications, enhancements, improvements, corrections or other changes without further notice to any product herein. Diodes Incorporated does not assume any liability arising out of the application or use of any product described herein; neither does it convey any license under its patent rights, nor the rights of others. The user of products in such applications shall assume all risks of such use and will agree to hold Diodes Incorporated and all the companies whose products are represented on our website, harmless against all damages.

LIFE SUPPORT

Diodes Incorporated products are not authorized for use as critical components in life support devices or systems without the expressed written approval of the President of Diodes Incorporated.