

TOSHIBA Bipolar Digital Integrated Circuit Silicon Monolithic

## ULQ2003AP, ULQ2003AFW (Manufactured by Toshiba Malaysia)

### 7-ch Darlington Sink Driver

The ULQ2003AP/AFW are high-voltage, high-current darlington drivers comprised of seven NPN darlington pairs. All units feature integral clamp diodes for switching inductive loads. Applications include relay, hammer, lamp and display (LED) drivers.

### Features

- Output current (single output): 500 mA (max)
- High sustaining voltage output: 50 V (max)
- Operating temperature:  $T_a = -40$  to  $105^\circ\text{C}$
- Output clamp diodes
- Inputs compatible with various types of logic
- Package type-AP: DIP-16pin
- Package type-AFW: SOL-16pin

Type	Input Base Resistor	Designation
ULQ2003AP/AFW	2.7 k $\Omega$	TTL, 5 V CMOS

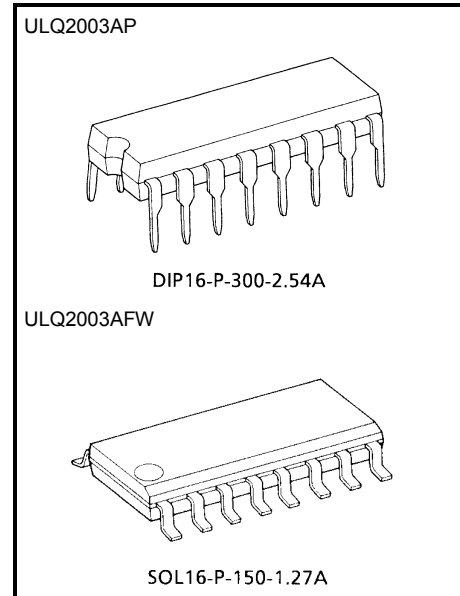

Weight  
 DIP16-P-300-2.54A: 1.11 g (typ.)  
 SOL16-P-150-1.27A: 0.15 g (typ.)

### Pin Connection (top view)

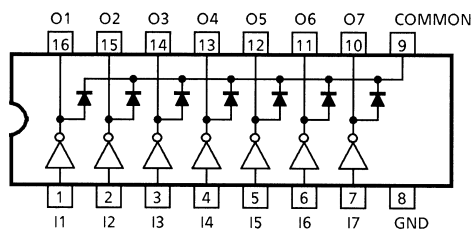

## Schematics (each driver)

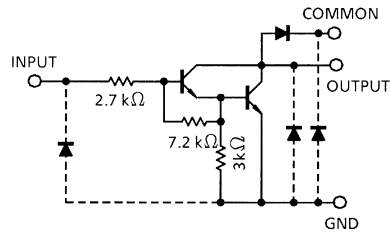

Note: The input and output parasitic diodes cannot be used as clamp diodes.

## Absolute Maximum Ratings (Ta = 25°C)

Characteristics	Symbol	Rating	Unit
Output sustaining voltage	$V_{CE(SUS)}$	-0.5 to 50	V
Output current	$I_{OUT}$	500	mA/ch
Input voltage	$V_{IN}$	-0.5 to 30	V
Clamp diode reverse voltage	$V_R$	50	V
Clamp diode forward current	$I_F$	500	mA
Power dissipation	AP	$P_D$	W
	AFW		
Operating Temperature	$T_{opr}$	-40 to 105	°C
Storage Temperature	$T_{stg}$	-55 to 150	°C

Note: On glass epoxy PCB (30 × 30 × 1.6 mm Cu 50%)

## Recommended Operating Conditions (Ta = -40 to 105°C)

Characteristics	Symbol	Test Condition	Min	Typ.	Max	Unit	
Output sustaining voltage	$V_{CE(SUS)}$		0	—	50	V	
Output current	$I_{OUT}$	$T_{pw} = 25\text{ ms}$ 7 Circuits $T_a = 105^\circ\text{C}$ $T_j = 120^\circ\text{C}$	Duty = 10%	0	—	200	mA/ch
			Duty = 50%	0	—	50	
			Duty = 10%	0	—	100	
			Duty = 50%	0	—	25	
Input voltage	$V_{IN}$		0	—	24	V	
Input voltage (output on)	$V_{IN(ON)}$	$I_{OUT} = 400\text{ mA}$ , $h_{FE} = 1000$	2.8	—	24	V	
Input voltage (output off)	$V_{IN(OFF)}$		0	—	0.7	V	
Clamp diode reverse voltage	$V_R$		—	—	50	V	
Clamp diode forward current	$I_F$		—	—	350	mA	
Power dissipation	AP	$P_D$	$T_a = 105^\circ\text{C}$	—	—	W	
	AFW						(Note)
						0.22	

Note: On glass epoxy PCB (30 × 30 × 1.6 mm Cu 50%)

## Electrical Characteristics (Ta = 25°C unless otherwise noted)

Characteristic	Symbol	Test Circuit	Test Condition	Min	Typ.	Max	Unit
Output leakage current	I <sub>CEX</sub>	1	V <sub>CE</sub> = 50 V, Ta = 25°C	—	—	50	μA
			V <sub>CE</sub> = 50 V, Ta = 105°C	—	—	100	
Collector-emitter saturation voltage	V <sub>CE (sat)</sub>	2	I <sub>OUT</sub> = 350 mA, I <sub>IN</sub> = 500 μA	—	1.3	1.6	V
			I <sub>OUT</sub> = 200 mA, I <sub>IN</sub> = 350 μA	—	1.1	1.3	
			I <sub>OUT</sub> = 100 mA, I <sub>IN</sub> = 250 μA	—	0.9	1.1	
DC current transfer ratio	h <sub>FE</sub>	2	V <sub>CE</sub> = 2 V, I <sub>OUT</sub> = 350 mA	1000	—	—	
Input current (output on)	I <sub>IN (ON)</sub>	3	V <sub>IN</sub> = 2.4 V, I <sub>OUT</sub> = 350 mA	—	0.4	0.7	mA
Input current (output off)	I <sub>IN (OFF)</sub>	4	I <sub>OUT</sub> = 500 μA, Ta = 85°C	50	65	—	μA
Input voltage (output on)	V <sub>IN (ON)</sub>	5	V <sub>CE</sub> = 2 V, I <sub>OUT</sub> = 350 mA	—	—	2.6	V
			h <sub>FE</sub> = 1000, I <sub>OUT</sub> = 200 mA	—	—	2.0	
Clamp diode reverse current	I <sub>R</sub>	6	V <sub>R</sub> = 50 V, Ta = 25°C	—	—	50	μA
			V <sub>R</sub> = 50 V, Ta = 105°C	—	—	100	
Clamp diode forward voltage	V <sub>F</sub>	7	I <sub>F</sub> = 350 mA	—	—	2.2	V
Input capacitance	C <sub>IN</sub>	—		—	15	—	pF
Turn-on delay	t <sub>ON</sub>	8	V <sub>OUT</sub> = 50 V, R <sub>L</sub> = 125 Ω C <sub>L</sub> = 15 pF	—	0.1	—	μs
Turn-off delay	t <sub>OFF</sub>	8	V <sub>OUT</sub> = 50 V, R <sub>L</sub> = 125 Ω C <sub>L</sub> = 15 pF	—	0.6	—	

## Test Circuit

### 1. $I_{CEX}$

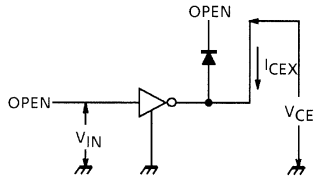

### 2. $V_{CE(sat)}$ , $h_{FE}$

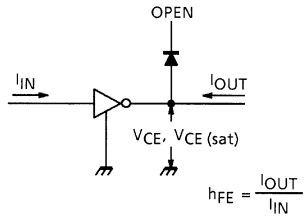

### 3. $I_{IN(ON)}$

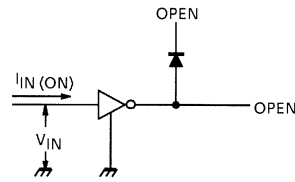

### 4. $I_{IN(OFF)}$

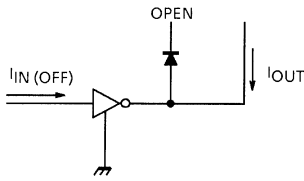

### 5. $V_{IN(ON)}$

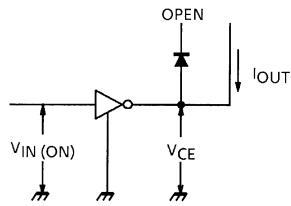

### 6. $I_R$

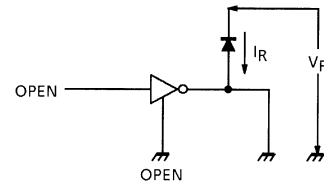

### 7. $V_F$

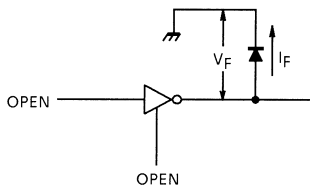

**8.  $t_{ON}$ ,  $t_{OFF}$**

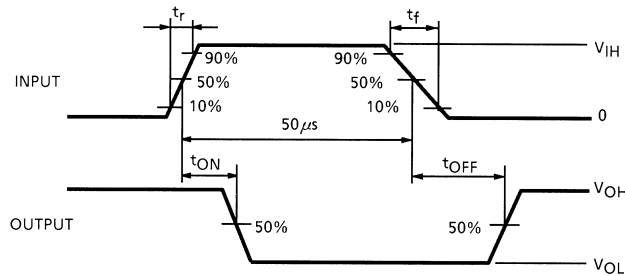
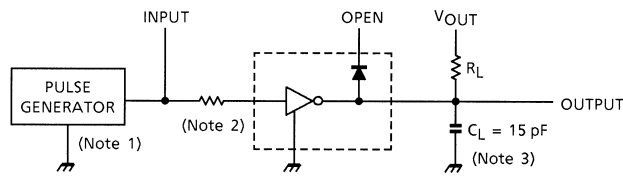

- Note 1: Pulse width 50  $\mu$ s, duty cycle 10%  
Output impedance 50  $\Omega$ ,  $t_r \leq 5$  ns,  $t_f \leq 10$  ns
- Note 2: See below

Input Condition

Type Number	R1	$V_{IH}$
ULQ2003AP/AFW	0	3 V

Note 3:  $C_L$  includes probe and jig capacitance.

**Precautions for Using**

This IC does not include built-in protection circuits for excess current or overvoltage. If this IC is subjected to excess current or overvoltage, it may be destroyed. Hence, the utmost care must be taken when systems which incorporate this IC are designed. Utmost care is necessary in the design of the output line, COMMON and GND line since IC may be destroyed due to short-circuit between outputs, air contamination fault, or fault by improper grounding.

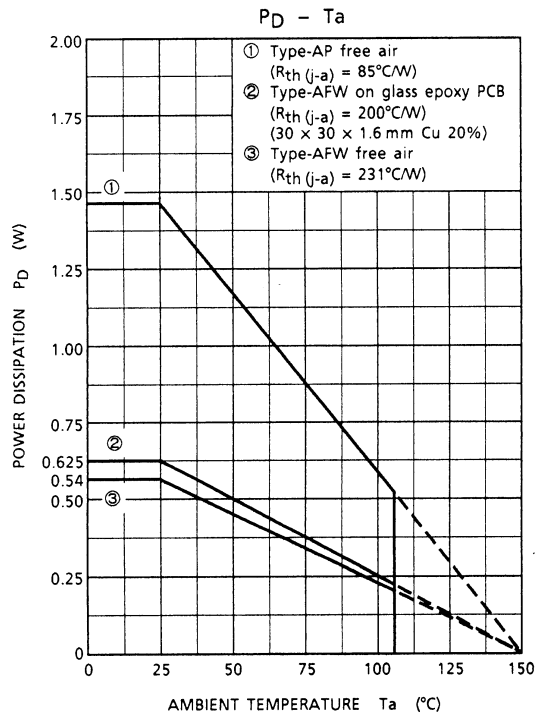

## Package Dimensions

DIP16-P-300-2.54A

Unit : mm

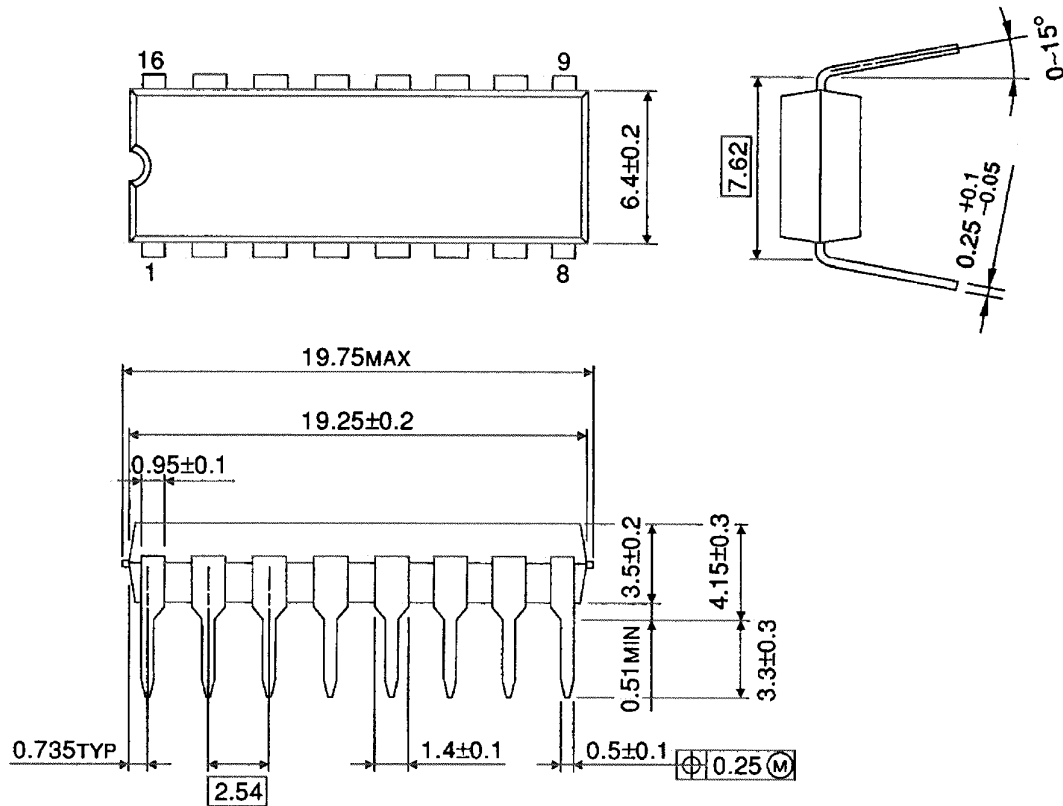

Weight: 1.11 g (typ.)

## Package Dimensions

SOL16-P-150-1.27A

Unit : mm

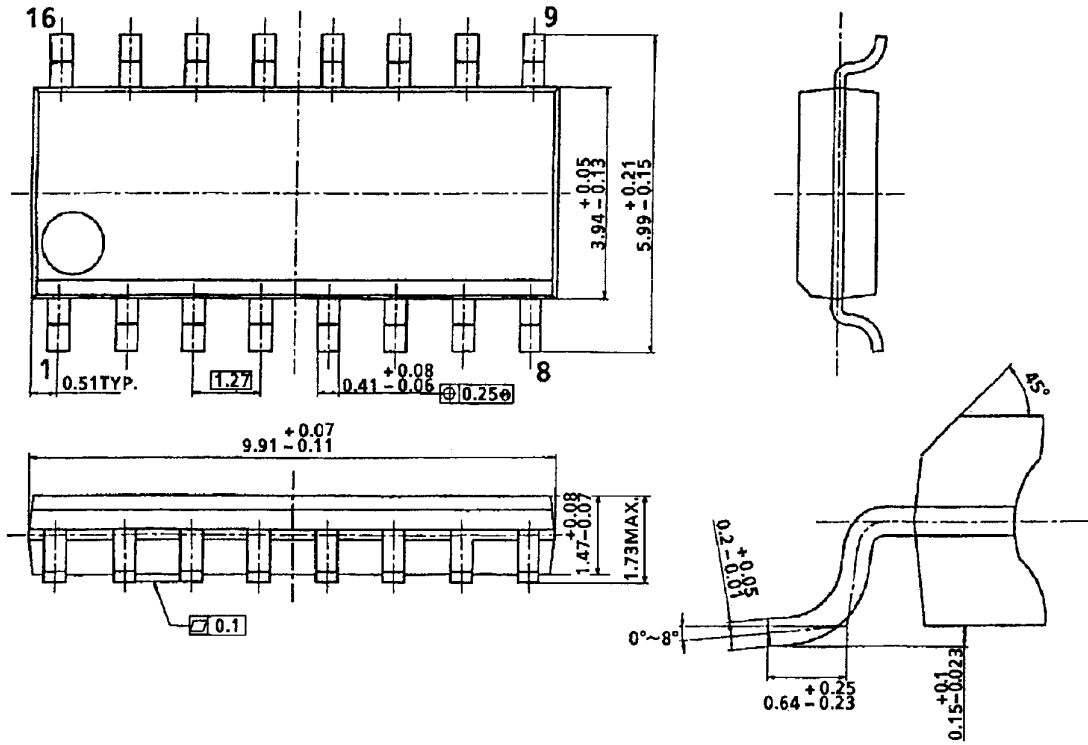

Weight: 0.15 g (typ.)



## Notes on Contents

### 1. Equivalent Circuits

The equivalent circuit diagrams may be simplified or some parts of them may be omitted for explanatory purposes.

### 2. Test Circuits

Components in the test circuits are used only to obtain and confirm the device characteristics. These components and circuits are not guaranteed to prevent malfunction or failure from occurring in the application equipment.

## IC Usage Considerations

### Notes on Handling of ICs

- (1) The absolute maximum ratings of a semiconductor device are a set of ratings that must not be exceeded, even for a moment. Do not exceed any of these ratings.  
Exceeding the rating(s) may cause the device breakdown, damage or deterioration, and may result injury by explosion or combustion.
- (2) Use an appropriate power supply fuse to ensure that a large current does not continuously flow in case of over current and/or IC failure. The IC will fully break down when used under conditions that exceed its absolute maximum ratings, when the wiring is routed improperly or when an abnormal pulse noise occurs from the wiring or load, causing a large current to continuously flow and the breakdown can lead smoke or ignition. To minimize the effects of the flow of a large current in case of breakdown, appropriate settings, such as fuse capacity, fusing time and insertion circuit location, are required.
- (3) If your design includes an inductive load such as a motor coil, incorporate a protection circuit into the design to prevent device malfunction or breakdown caused by the current resulting from the inrush current at power ON or the negative current resulting from the back electromotive force at power OFF. IC breakdown may cause injury, smoke or ignition.  
Use a stable power supply with ICs with built-in protection functions. If the power supply is unstable, the protection function may not operate, causing IC breakdown. IC breakdown may cause injury, smoke or ignition.
- (4) Do not insert devices in the wrong orientation or incorrectly.  
Make sure that the positive and negative terminals of power supplies are connected properly. Otherwise, the current or power consumption may exceed the absolute maximum rating, and exceeding the rating(s) may cause the device breakdown, damage or deterioration, and may result injury by explosion or combustion.  
In addition, do not use any device that is applied the current with inserting in the wrong orientation or incorrectly even just one time.
- (5) Carefully select external components (such as inputs and negative feedback capacitors) and load components (such as speakers), for example, power amp and regulator.  
If there is a large amount of leakage current such as input or negative feedback condenser, the IC output DC voltage will increase. If this output voltage is connected to a speaker with low input withstand voltage, overcurrent or IC failure can cause smoke or ignition. (The over current can cause smoke or ignition from the IC itself.) In particular, please pay attention when using a Bridge Tied Load (BTL) connection type IC that inputs output DC voltage to a speaker directly.

**Points to Remember on Handling of ICs**

## (1) Heat Radiation Design

In using an IC with large current flow such as power amp, regulator or driver, please design the device so that heat is appropriately radiated, not to exceed the specified junction temperature ( $T_j$ ) at any time and condition. These ICs generate heat even during normal use. An inadequate IC heat radiation design can lead to decrease in IC life, deterioration of IC characteristics or IC breakdown. In addition, please design the device taking into consideration the effect of IC heat radiation with peripheral components.

## (2) Back-EMF

When a motor rotates in the reverse direction, stops or slows down abruptly, a current flow back to the motor's power supply due to the effect of back-EMF. If the current sink capability of the power supply is small, the device's motor power supply and output pins might be exposed to conditions beyond maximum ratings. To avoid this problem, take the effect of back-EMF into consideration in system design.

**RESTRICTIONS ON PRODUCT USE**

060116EBA

- The information contained herein is subject to change without notice. 021023\_D
- TOSHIBA is continually working to improve the quality and reliability of its products. Nevertheless, semiconductor devices in general can malfunction or fail due to their inherent electrical sensitivity and vulnerability to physical stress. It is the responsibility of the buyer, when utilizing TOSHIBA products, to comply with the standards of safety in making a safe design for the entire system, and to avoid situations in which a malfunction or failure of such TOSHIBA products could cause loss of human life, bodily injury or damage to property.  
In developing your designs, please ensure that TOSHIBA products are used within specified operating ranges as set forth in the most recent TOSHIBA products specifications. Also, please keep in mind the precautions and conditions set forth in the "Handling Guide for Semiconductor Devices," or "TOSHIBA Semiconductor Reliability Handbook" etc. 021023\_A
- The TOSHIBA products listed in this document are intended for usage in general electronics applications (computer, personal equipment, office equipment, measuring equipment, industrial robotics, domestic appliances, etc.). These TOSHIBA products are neither intended nor warranted for usage in equipment that requires extraordinarily high quality and/or reliability or a malfunction or failure of which may cause loss of human life or bodily injury ("Unintended Usage"). Unintended Usage include atomic energy control instruments, airplane or spaceship instruments, transportation instruments, traffic signal instruments, combustion control instruments, medical instruments, all types of safety devices, etc. Unintended Usage of TOSHIBA products listed in this document shall be made at the customer's own risk. 021023\_B
- The products described in this document shall not be used or embedded to any downstream products of which manufacture, use and/or sale are prohibited under any applicable laws and regulations. 060106\_Q
- The information contained herein is presented only as a guide for the applications of our products. No responsibility is assumed by TOSHIBA for any infringements of patents or other rights of the third parties which may result from its use. No license is granted by implication or otherwise under any patent or patent rights of TOSHIBA or others. 021023\_C
- The products described in this document are subject to the foreign exchange and foreign trade laws. 021023\_E