

IGBT MODULE (U series) 600V / 30A / PIM



■ Features

- Low $V_{CE(sat)}$
- Compact Package
- P.C. Board Mount Module
- Converter Diode Bridge Dynamic Brake Circuit

■ Applications

- Inverter for Motoe Drive
- AC and DC Servo Drive Amplifier
- Uninterruptible Power Supply

■ Maximum ratings and characteristics

● Absolute maximum ratings ($T_c=25^\circ\text{C}$ unless ptherwise specified)

Item	Symbol	Condition	Rating	Unit	
Inverter	Collector-Emitter voltage	V_{CES}	600	V	
	Gate-Emitter voltage	V_{GES}	± 20	V	
	Collector current	I_C	Continuous	30	A
		I_{CP}	1ms	60	
		$-I_C$		30	
		$-I_C$ pulse	1ms	60	
Collector power dissipation	P_C	1 device	133	W	
Brake	Collector-Emitter voltage	V_{CES}	600	V	
	Gate-Emitter voltage	V_{GES}	± 20	V	
	Collector current	I_C	Continuous	20	A
		I_{CP}	1ms	40	A
	Collector power dissipation	P_C	1 device	104	W
	Repetitive peak reverse voltage	V_{RRM}		600	V
Converter	Repetitive peak reverse voltage	V_{RRM}	800	V	
	Average output current	I_o	50Hz/60Hz sine wave	30	A
	Surge current (Non-Repetitive)	I_{FSM}	$T_j=150^\circ\text{C}$, 10ms	210	A
	I^2t (Non-Repetitive)	I^2t	half sine wave	221	A^2s
Operating junction temperature	T_j		+150	$^\circ\text{C}$	
Storage temperature	T_{stg}		-40 to +125	$^\circ\text{C}$	
Isolation voltage	between terminal and copper base *2 between thermistor and others *3	V_{iso}	AC : 1 minute	AC 2500	V
				AC 2500	
Mounting screw torque			3.5 *1	N·m	

*1 Recommendable value : 2.5 to 3.5 N·m (M5)

*2 All terminals should be connected together when isolation test will be done.

*3 Two thermistor terminals should be connected together, each other terminals should be connected together and shorted to base plate when isolation test will be done.

● Electrical characteristics (T_j=25°C unless otherwise specified)

Item	Symbol	Condition	Characteristics			Unit			
			Min.	Typ.	Max.				
Inverter	Zero gate voltage collector current	ICES	V _{CE} =600V, V _{GE} =0V			1.0	mA		
	Gate-Emitter leakage current	IGES	V _{CE} =0V, V _{GE} =±20V			200	nA		
	Gate-Emitter threshold voltage	V _{GE(th)}	V _{CE} =20V, I _C =30mA			6.2	6.7	7.7	V
	Collector-Emitter saturation voltage	V _{CE(sat)} (terminal)	V _{GE} =15V I _C =30A	T _J =25°C		2.10	2.40	V	
				T _J =125°C		2.40			
		V _{CE(sat)} (chip)		T _J =25°C		1.85			
				T _J =125°C		2.15			
	Input capacitance	C _{ies}	V _{GE} =0V, V _{CE} =10V, f=1MHz			1.7		nF	
	Turn-on time	t _{on}	V _{CC} =300V			0.36	1.20	μs	
		t _r	I _C =30A			0.20	0.60		
		t _{r(i)}	V _{GE} =±15V			0.05			
	Turn-off time	t _{off}	R _G =120Ω			0.45	1.20	μs	
t _f					0.04	0.45			
Forward on voltage	V _F (terminal)	V _{GE} =0V I _F =30A	T _J =25°C		2.10	2.65	V		
			T _J =125°C		2.00				
	V _F (chip)		T _J =25°C		1.85				
			T _J =125°C		1.75				
Reverse recovery time	t _{rr}	I _F =30A				0.35	μs		
Brake	Zero gate voltage collector current	ICES	V _{CE} =600V, V _{GE} =0V			1.0	mA		
	Gate-Emitter leakage current	IGES	V _{CE} =0V, V _{GE} =±20V			200	nA		
	Collector-Emitter saturation voltage	V _{CE(sat)} (terminal)	I _C =20A V _{GE} =15V	T _J =25°C		1.85	2.15	V	
				T _J =125°C		2.15			
		V _{CE(sat)} (chip)		T _J =25°C		1.70			
				T _J =125°C		2.00			
	Turn-on time	t _{on}	V _{CC} =300V			0.45	1.20	μs	
		t _r	I _C =20A			0.15	0.60		
	Turn-off time	t _{off}	V _{GE} =±15V			0.37	1.20	μs	
		t _f	R _G =150Ω			0.04	0.45		
	Reverse current	I _{RRM}	V _R =600V				1.0	mA	
	Converter	Forward on voltage	V _{FM}	I _F =30A	terminal	1.20	1.50	V	
V _{GE} =0V				chip	1.10				
Reverse current	I _{RRM}	V _R =800V				1.0	mA		
Thermistor	Resistance	R	T=25°C			5000	Ω		
			T=100°C			465		495	520
B value	B	T=25/50°C			3305	3375	3450	K	

● Thermal resistance Characteristics

Item	Symbol	Condition	Characteristics			Unit
			Min.	Typ.	Max.	
Thermal resistance (1 device)	R _{th(j-c)}	Inverter IGBT			0.94	°C/W
		Inverter FWD			1.60	
		Brake IGBT			1.20	
		Converter Diode			1.20	
Contact thermal resistance *	R _{th(c-f)}	With thermal compound			0.05	

* This is the value which is defined mounting on the additional cooling fin with thermal compound

■ Equivalent Circuit Schematic

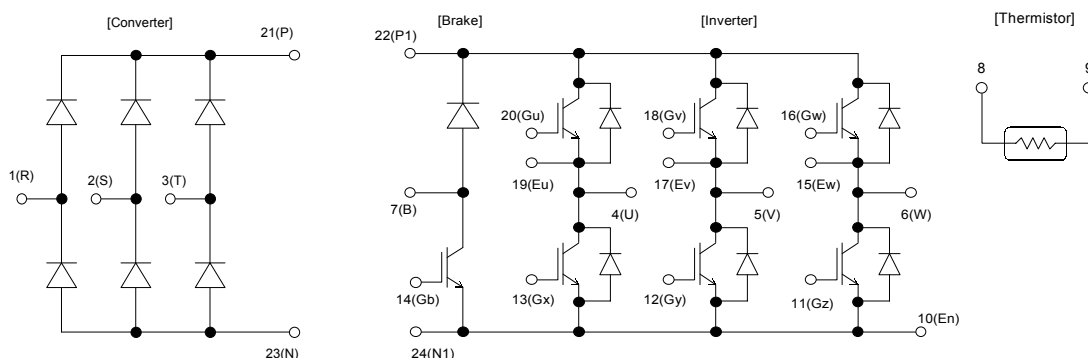

■ Characteristics (Representative)

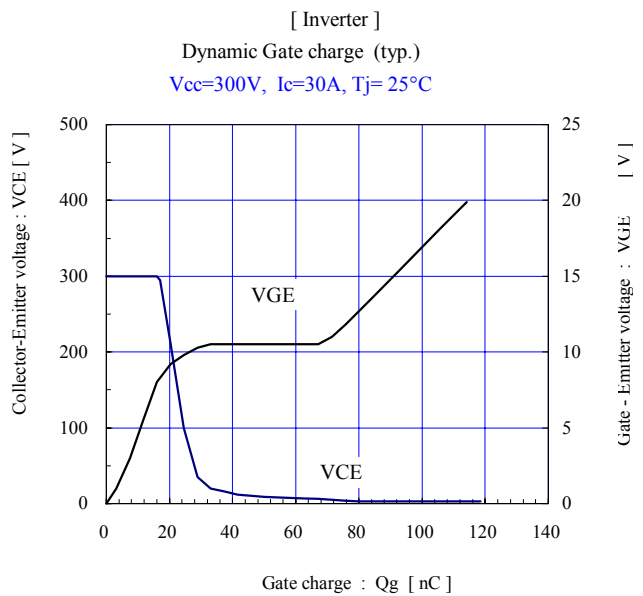
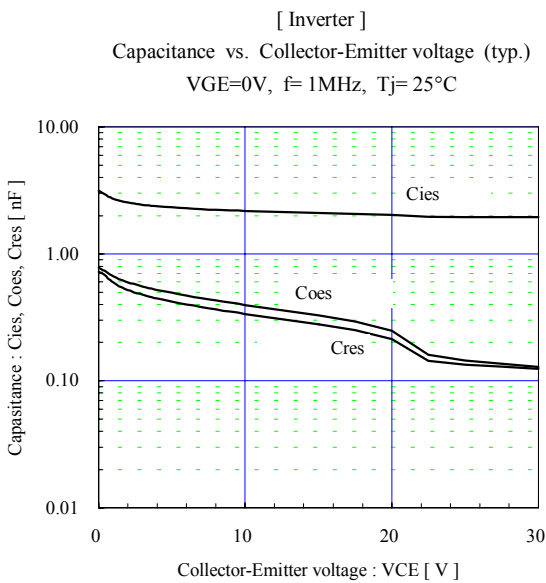
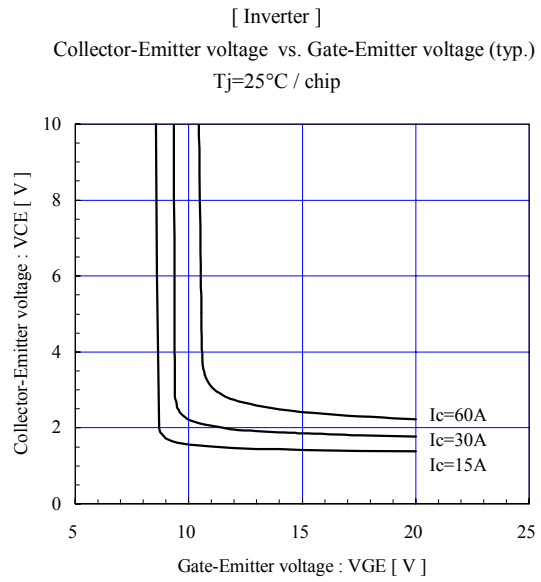
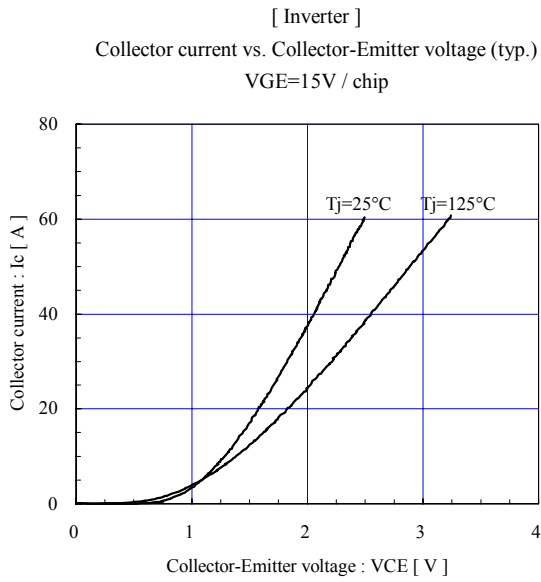
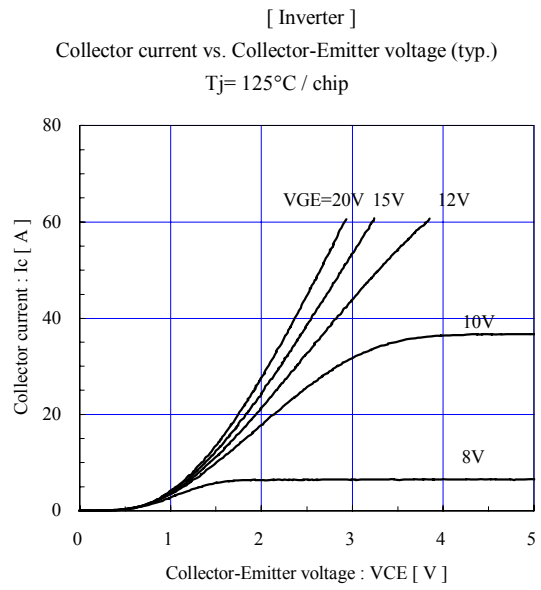
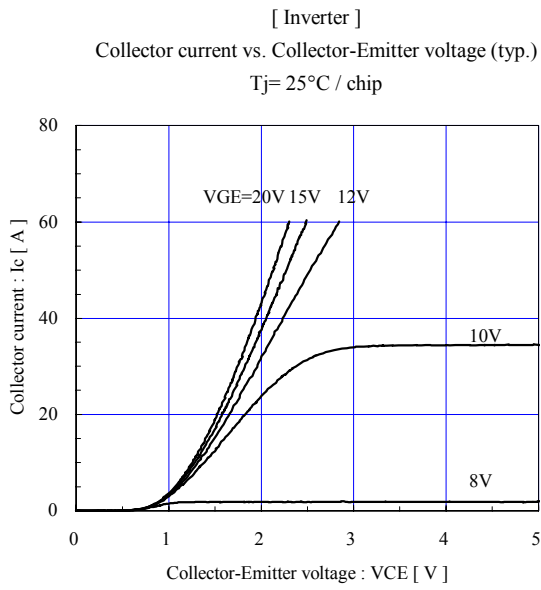

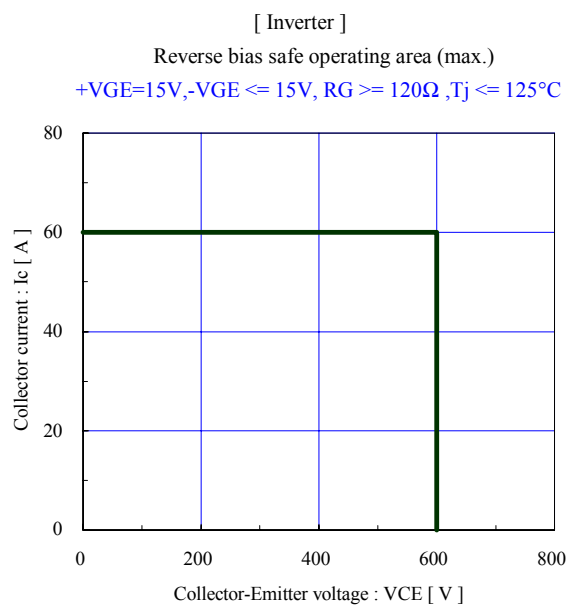
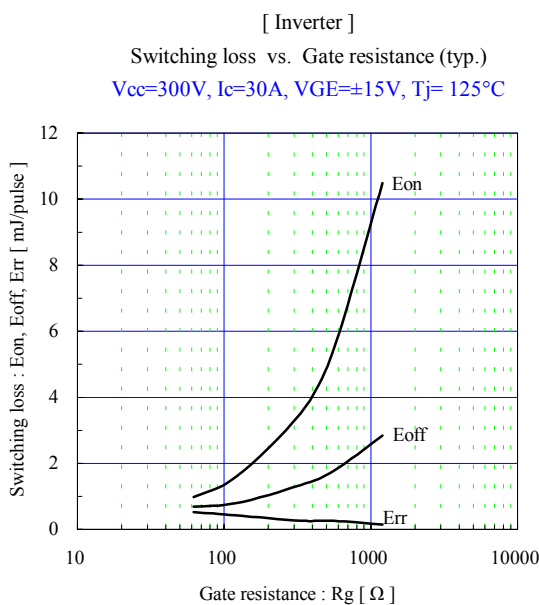
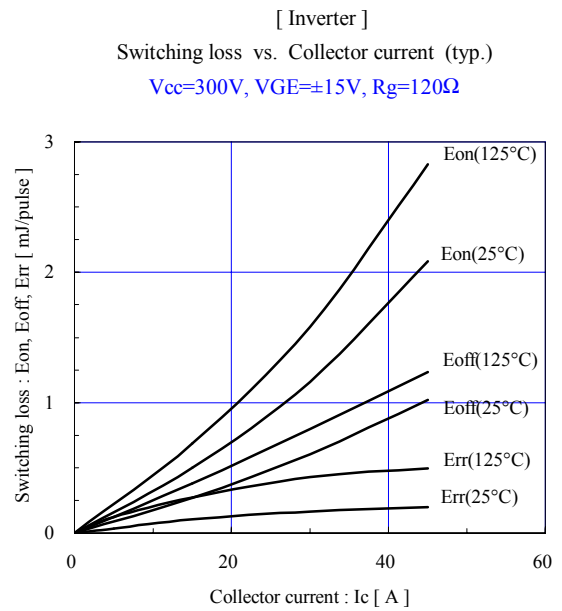
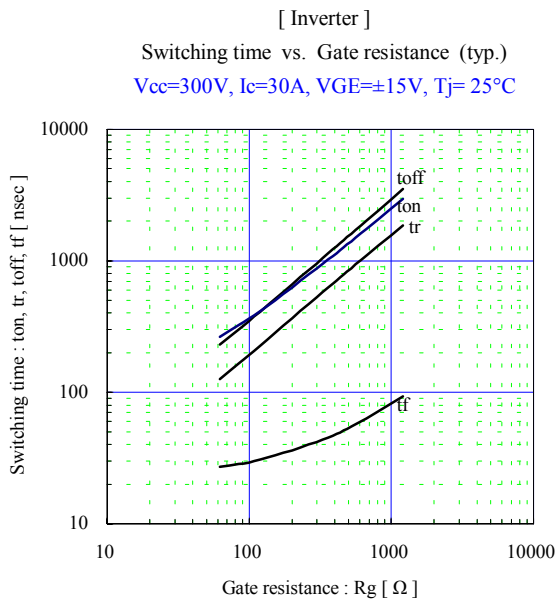
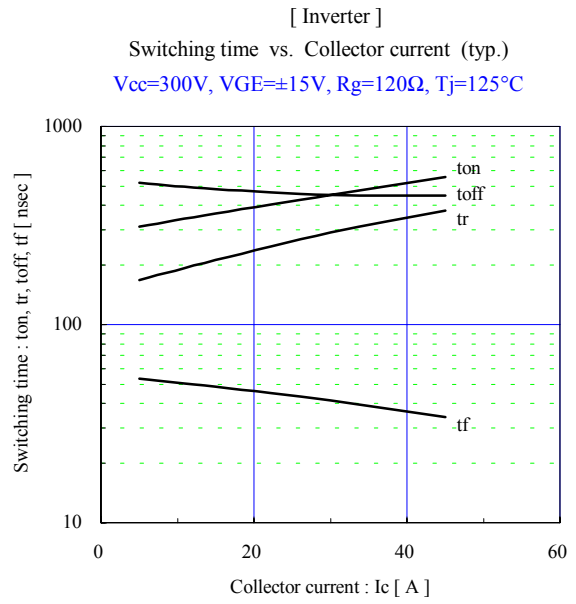
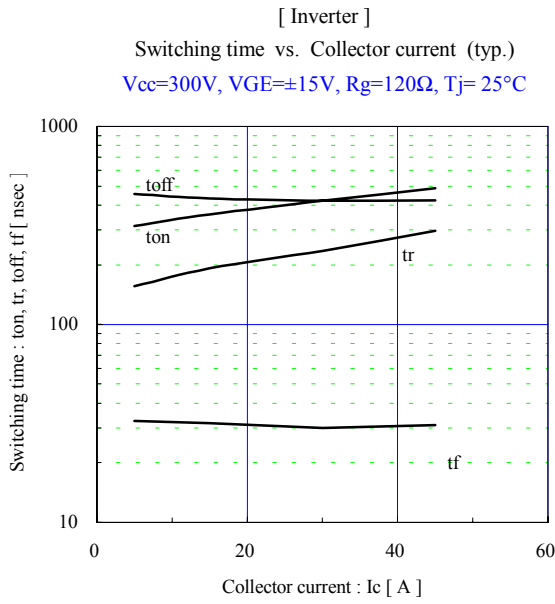

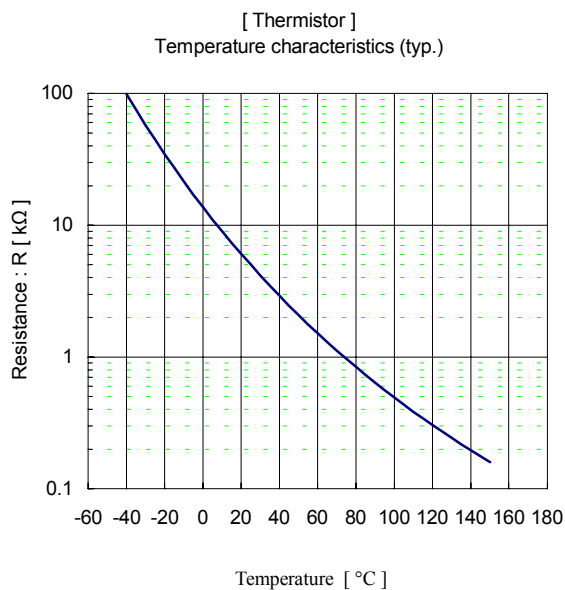
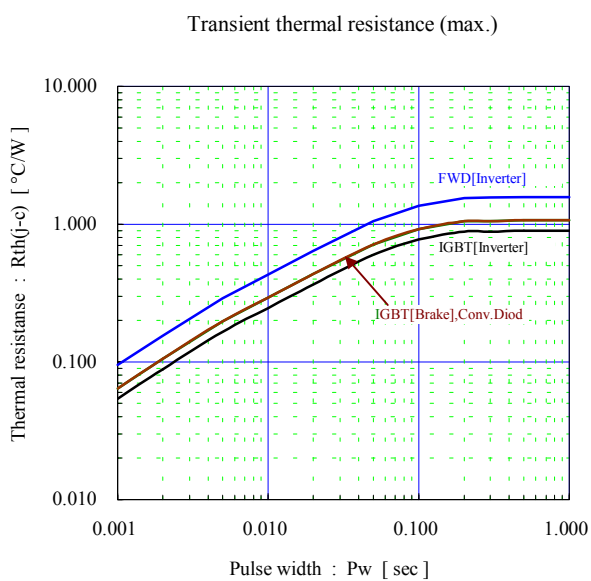
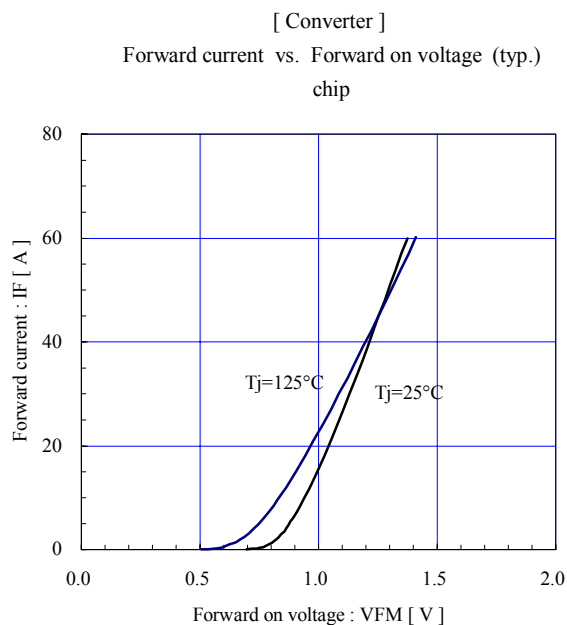
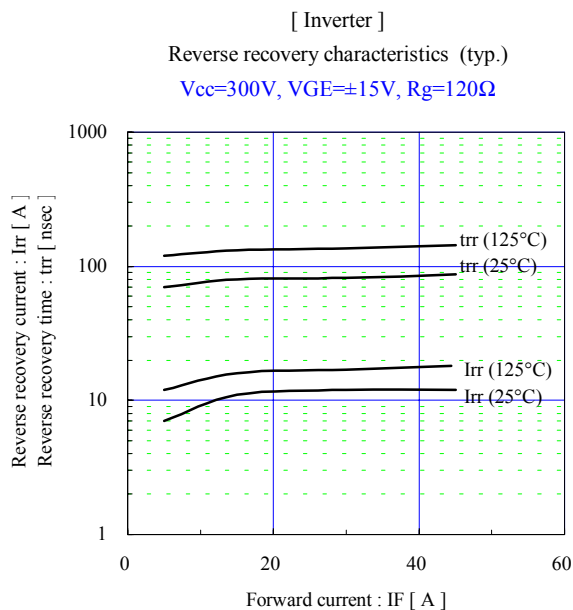
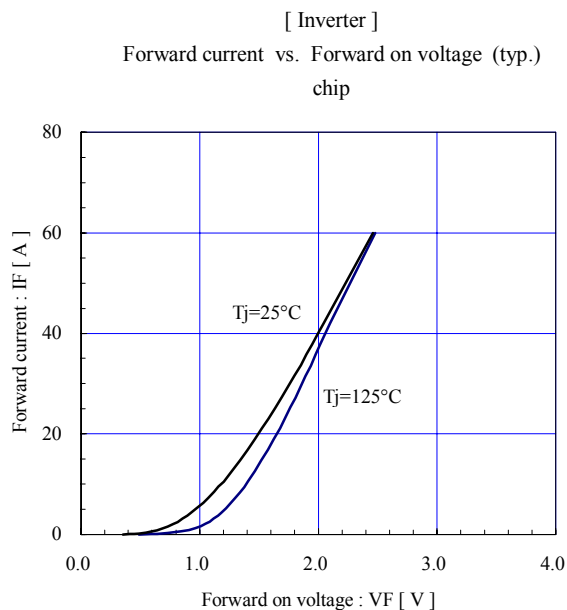

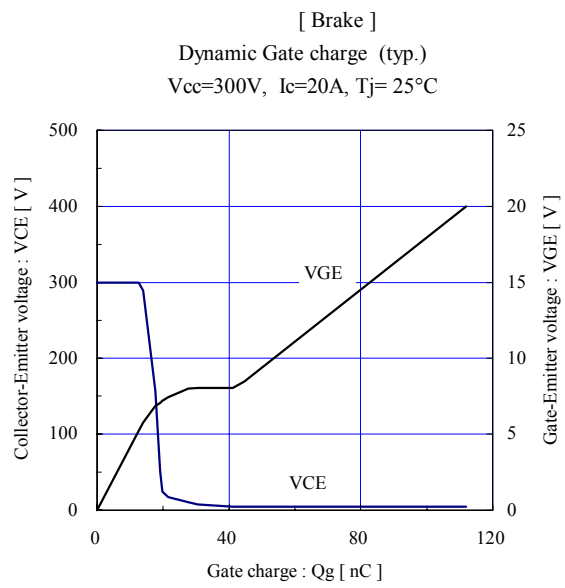
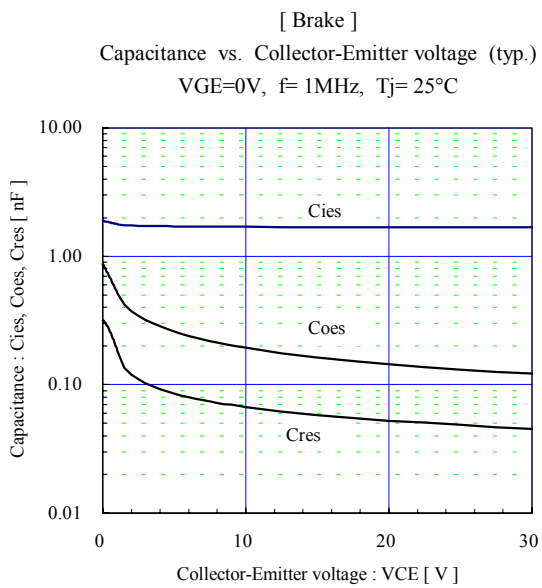
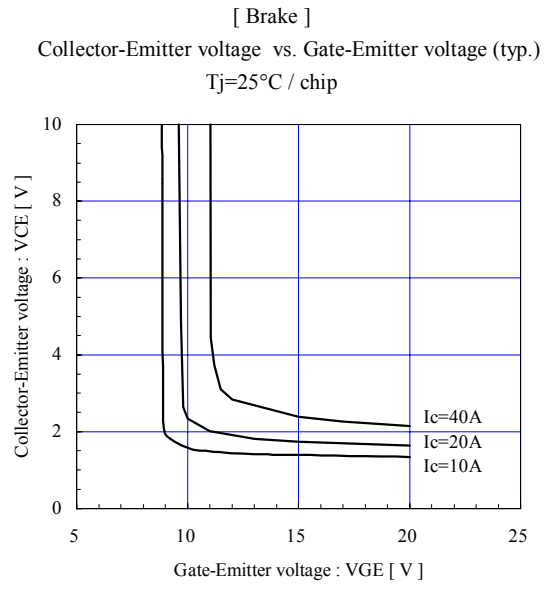
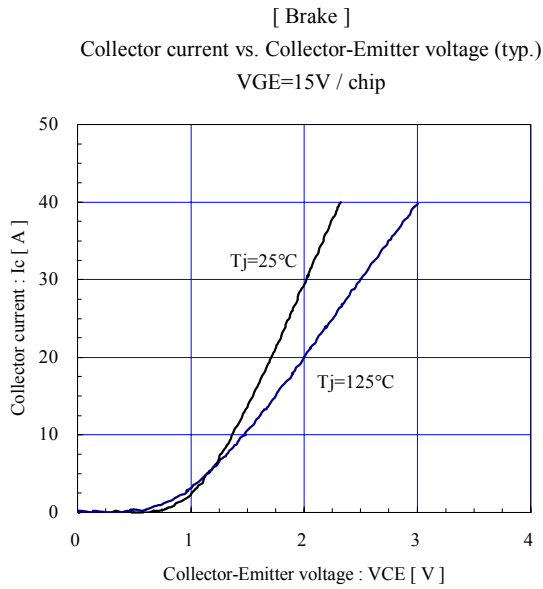
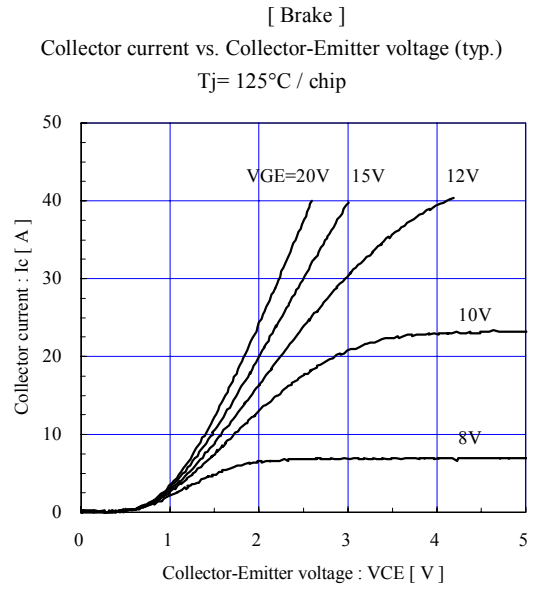
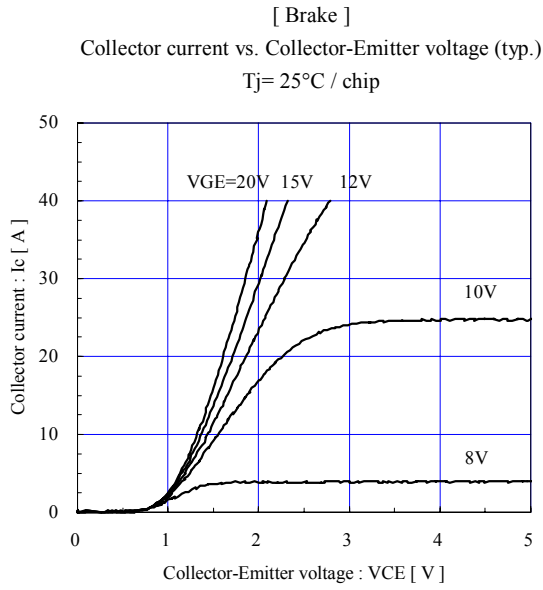

■ Outline Drawings, mm

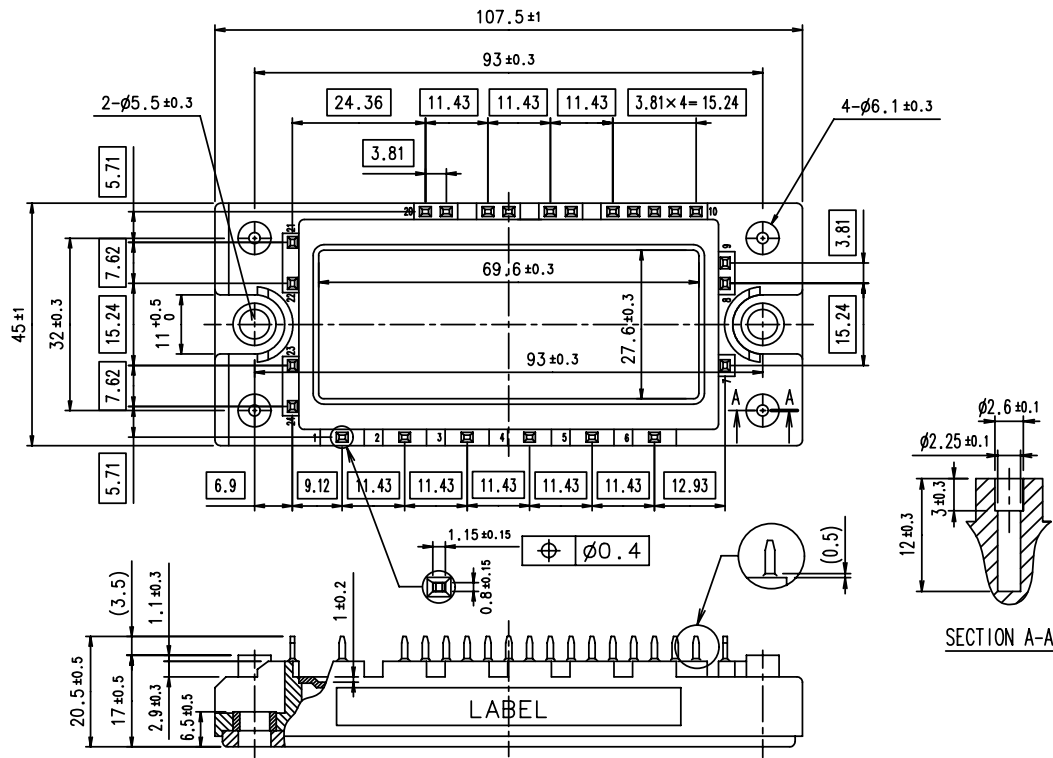

□ shows theoretical dimension.
 () shows reference dimension.