

IGBT MODULE (U series) 600V / 100A / PIM



■ Features

- Low $V_{CE(sat)}$
- Compact Package
- P.C. Board Mount Module
- Converter Diode Bridge Dynamic Brake Circuit

■ Applications

- Inverter for Motoe Drive
- AC and DC Servo Drive Amplifier
- Uninterruptible Power Supply

■ Maximum ratings and characteristics

● Absolute maximum ratings ($T_c=25^{\circ}\text{C}$ unless otherwise specified)

Item	Symbol	Condition	Rating	Unit	
Inverter	Collector-Emitter voltage	V_{CES}	600	V	
	Gate-Emitter voltage	V_{GES}	± 20	V	
	Collector current	I_C	Continuous	100	A
		I_{CP}	1ms	200	A
		$-I_C$		100	A
		$-I_C$ pulse	1ms	200	
Collector power dissipation	P_C	1 device	378	W	
Brake	Collector-Emitter voltage	V_{CES}	600	V	
	Gate-Emitter voltage	V_{GES}	± 20	V	
	Collector current	I_C	Continuous	50	A
		I_{CP}	1ms	100	A
	Collector power dissipation	P_C	1 device	187	W
Converter	Repetitive peak reverse voltage	V_{RRM}	600	V	
	Repetitive peak reverse voltage	V_{RRM}	800	V	
	Average output current	I_b	50Hz/60Hz sine wave	100	A
	Surge current (Non-Repetitive)	I_{FSM}	$T_j=150^{\circ}\text{C}$, 10ms	700	A
	I^2t (Non-Repetitive)	I^2t	half sine wave	2450	A^2s
Operating junction temperature	T_j		+150	$^{\circ}\text{C}$	
Storage temperature	T_{stg}		-40 to +125	$^{\circ}\text{C}$	
Isolation voltage	between terminal and copper base *2	V_{iso}	AC : 1 minute	AC 2500	V
	between thermistor and others *3			AC 2500	V
Mounting screw torque			3.5 *1	N·m	

*1 Recommendable value : 2.5 to 3.5 N·m (M5)

*2 All terminals should be connected together when isolation test will be done.

*3 Two thermistor terminals should be connected together, each other terminals should be connected together and shorted to base plate when isolation test will be done.

● Electrical characteristics (Tj=25°C unless otherwise specified)

Item	Symbol	Condition	Characteristics			Unit			
			Min.	Typ.	Max.				
Inverter	Zero gate voltage collector current	ICES	VCE=600V, VGE=0V			1.0	mA		
	Gate-Emitter leakage current	IGES	VCE=0V, VGE=±20V			200	nA		
	Gate-Emitter threshold voltage	VGE(th)	VCE=20V, IC=100mA			6.2	6.7	7.7	V
	Collector-Emitter saturation voltage	VCE(sat) (terminal)	VGE=15V IC=100A	Tj=25°C		2.30	2.60	V	
				Tj=125°C		2.50			
		VCE(sat) (chip)		Tj=25°C		1.85			
				Tj=125°C		2.00			
	Input capacitance	Cies	VGE=0V, VCE=10V, f=1MHz			8.4		nF	
	Turn-on time	ton	VCC=300V			0.51	1.20	µs	
		tr	IC=100A			0.22	0.60		
		tr(i)	VGE=±15V			0.16			
	Turn-off time	toff	RG=33Ω			0.58	1.20	µs	
tf					0.07	0.45			
Forward on voltage	VF (terminal)	VGE=0V IF=100A	Tj=25°C		2.10	2.40	V		
			Tj=125°C		2.40				
	VF (chip)		Tj=25°C		1.60				
			Tj=125°C		1.65				
Reverse recovery time	trr	IF=100A				0.35	µs		
Brake	Zero gate voltage collector current	ICES	VCE=600V, VGE=0V			1.0	mA		
	Gate-Emitter leakage current	IGES	VCE=0V, VGE=±20V			200	nA		
	Collector-Emitter saturation voltage	VCE(sat) (terminal)	IC=50A VGE=15V	Tj=25°C		2.10	2.40	V	
				Tj=125°C		2.40			
		VCE(sat) (chip)		Tj=25°C		1.85			
				Tj=125°C		2.15			
	Turn-on time	ton	VCC=300V			0.42	1.20	µs	
		tr	IC=50A			0.24	0.60		
	Turn-off time	toff	VGE=±15V			0.42	1.20	µs	
		tf	RG=68Ω			0.03	0.45		
	Reverse current	IRRM	VR=600V				1.0	mA	
	Converter	Forward on voltage	VFM	IF=100A	terminal	1.20	1.50	V	
VGE=0V				chip	1.10				
Reverse current	IRRM	VR=800V				1.0	mA		
Thermistor	Resistance	R	T=25°C			5000	Ω		
			T=100°C			465		495	520
B value	B	T=25/50°C			3305	3375	3450	K	

● Thermal resistance Characteristics

Item	Symbol	Condition	Characteristics			Unit
			Min.	Typ.	Max.	
Thermal resistance (1 device)	Rth(j-c)	Inverter IGBT			0.33	°C/W
		Inverter FWD			0.67	
		Brake IGBT			0.67	
		Converter Diode			0.47	
Contact thermal resistance *	Rth(c-f)	With thermal compound			0.05	

* This is the value which is defined mounting on the additional cooling fin with thermal compound

■ Equivalent Circuit Schematic

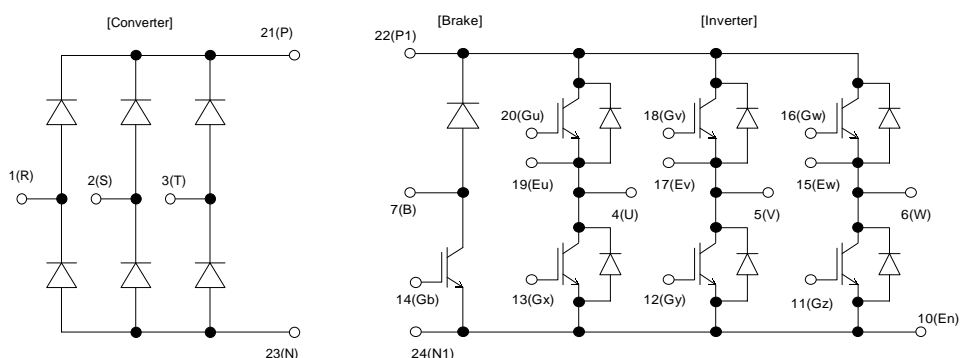

■ Characteristics (Representative)

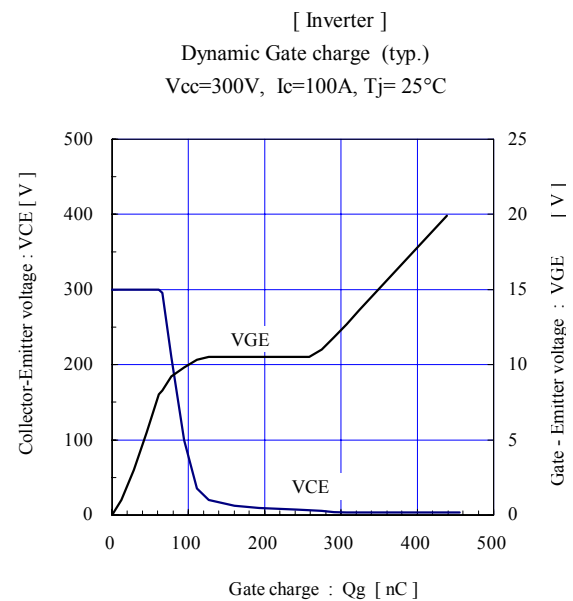
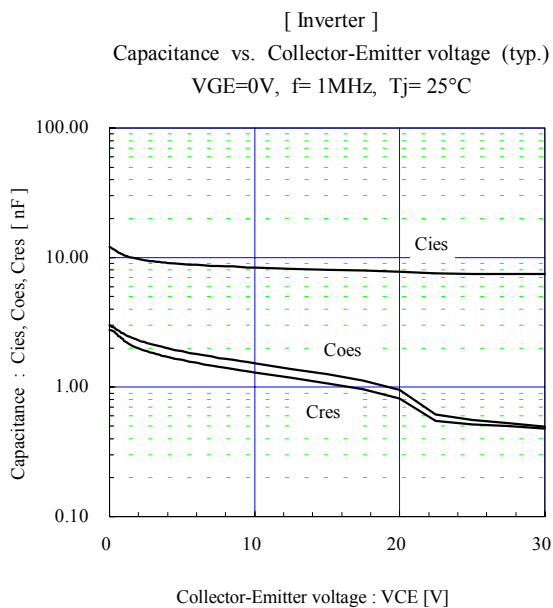
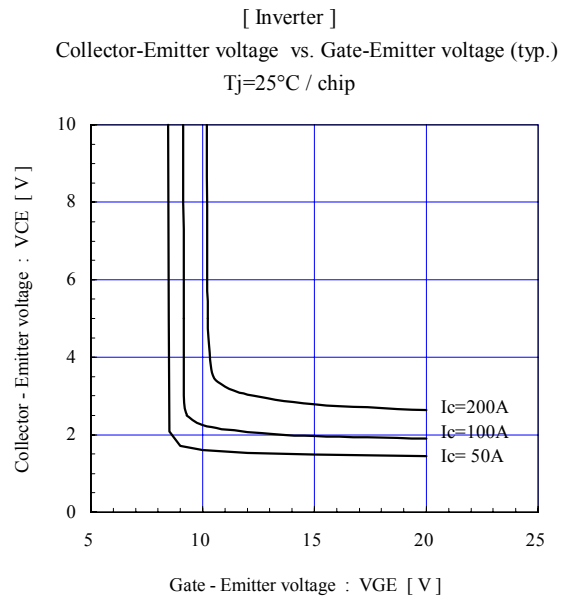
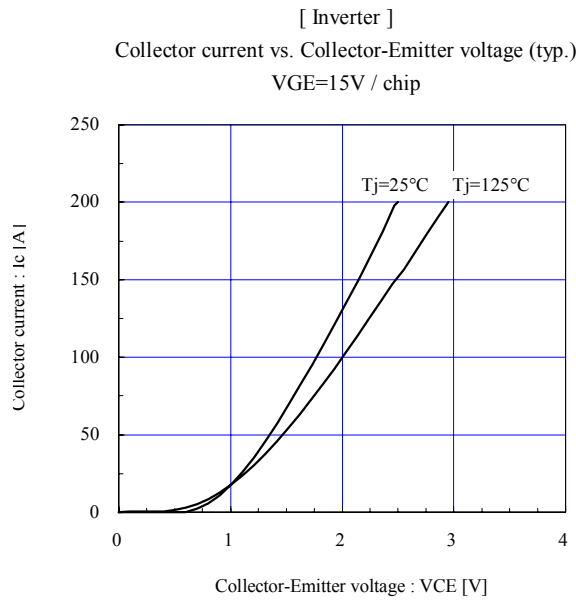
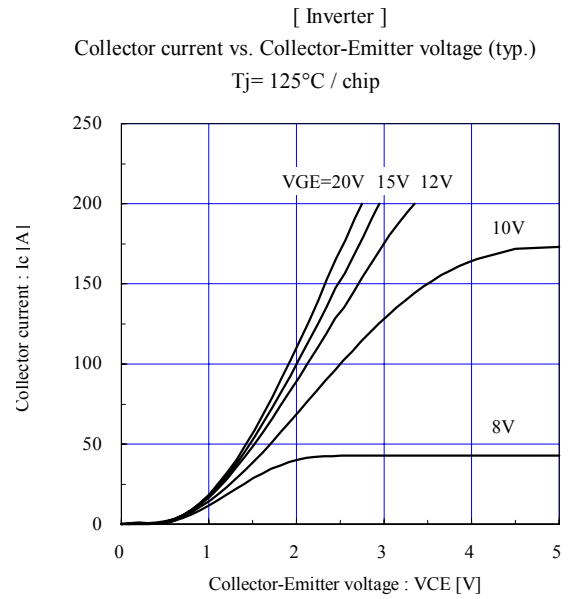
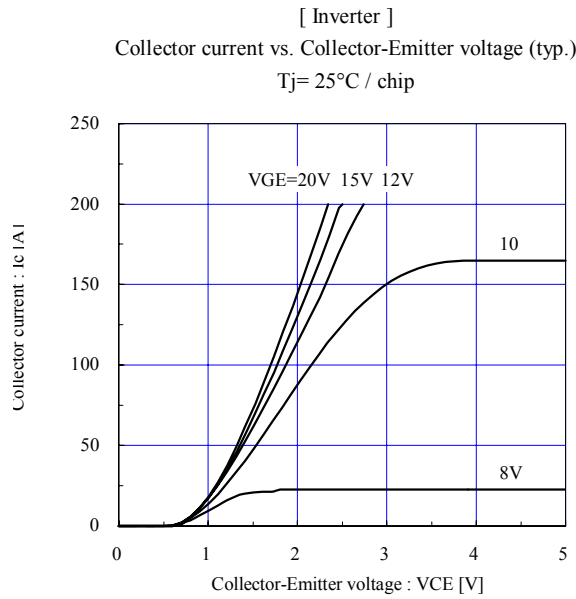

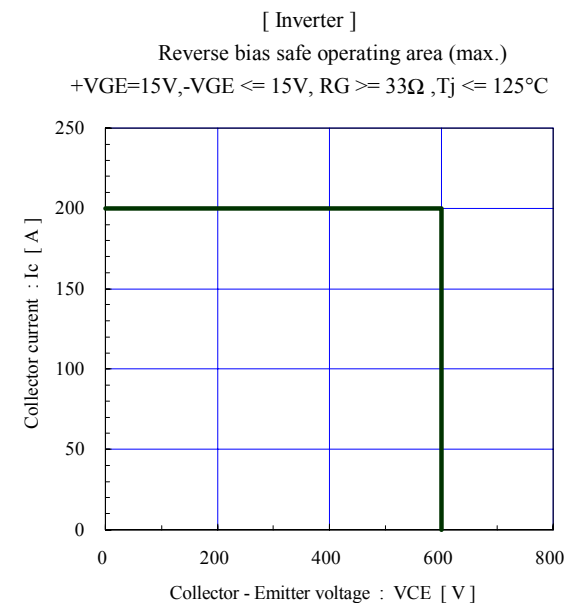
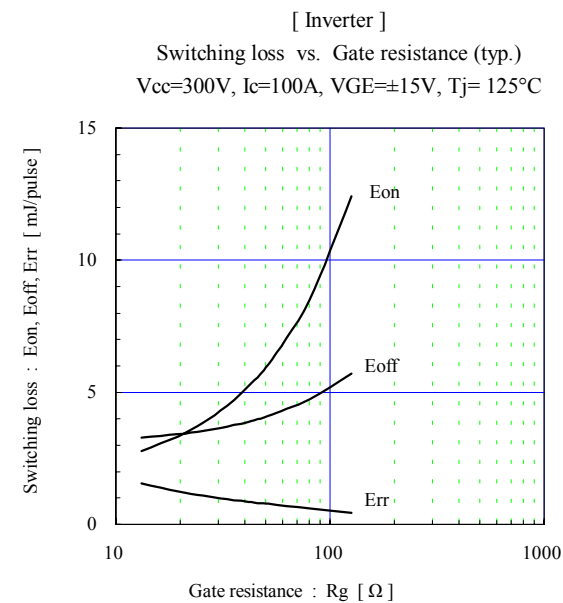
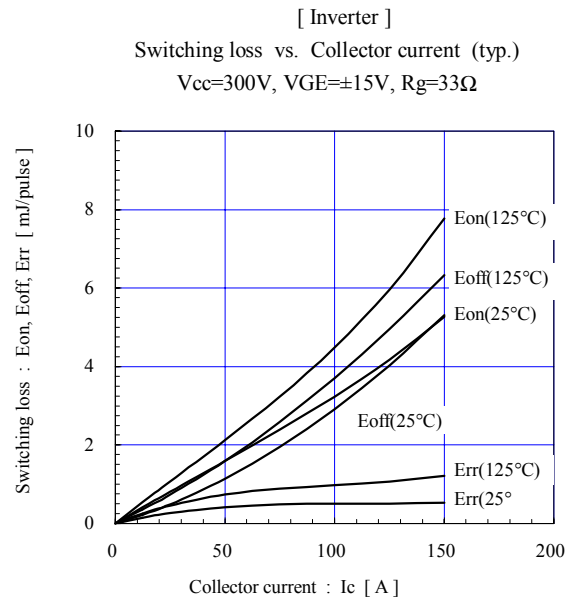
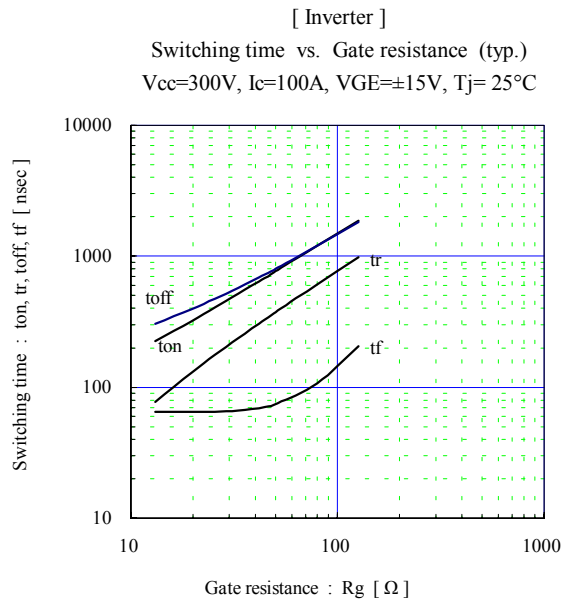
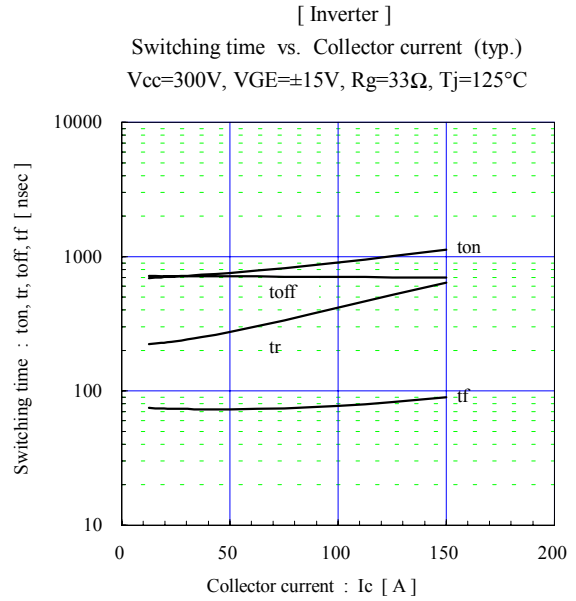
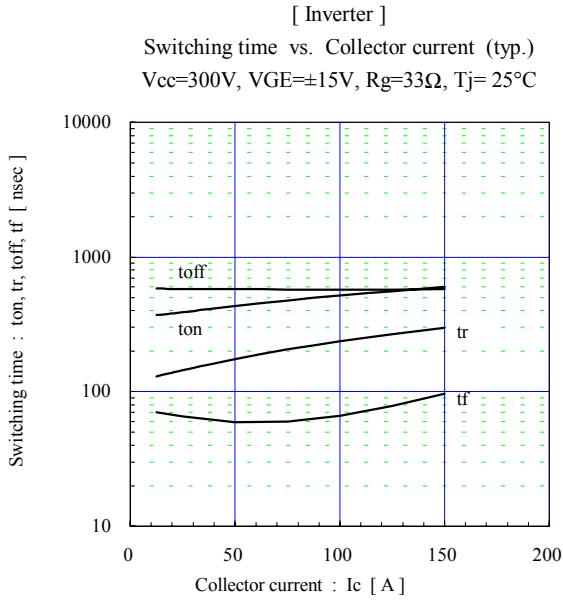

Forward current vs. Forward on voltage (typ.)
chip

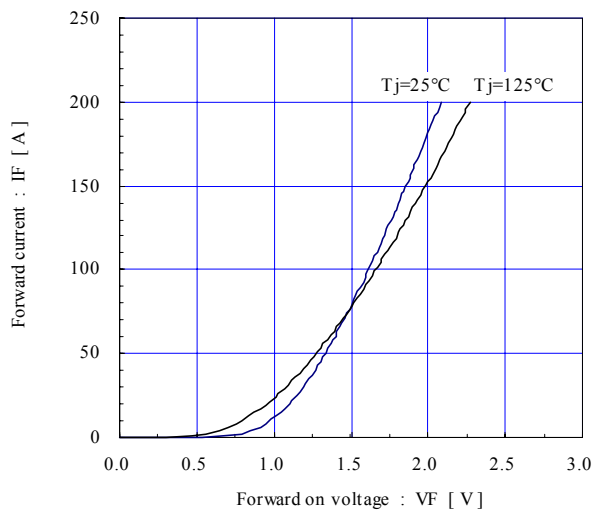

Reverse recovery characteristics (typ.)
 $V_{cc}=300\text{V}$, $V_{GE}=\pm 15\text{V}$, $R_g=33\Omega$

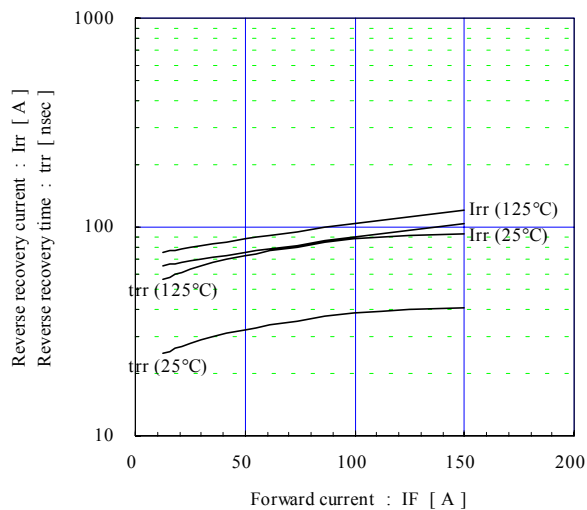

[Converter]

Forward current vs. Forward on voltage (typ.)
chip

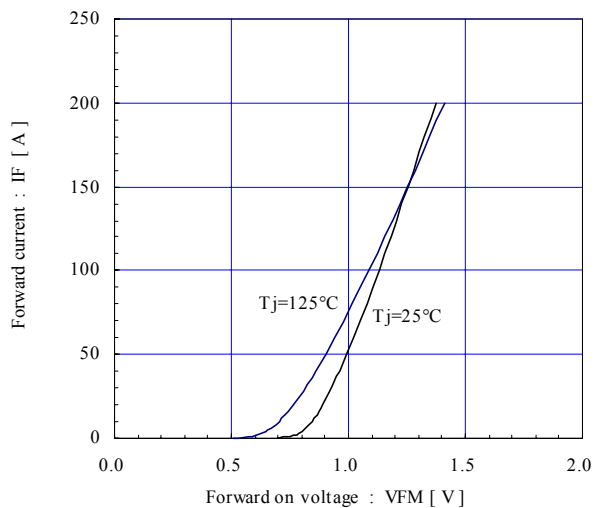

[Thermistor]

Transient thermal resistance (max.)

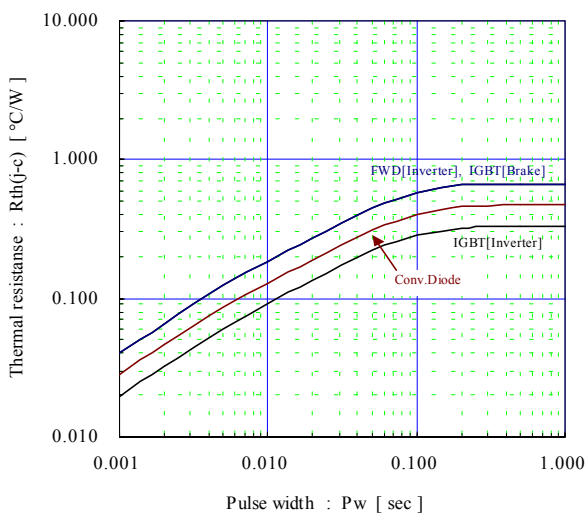

Temperature characteristic (typ.)

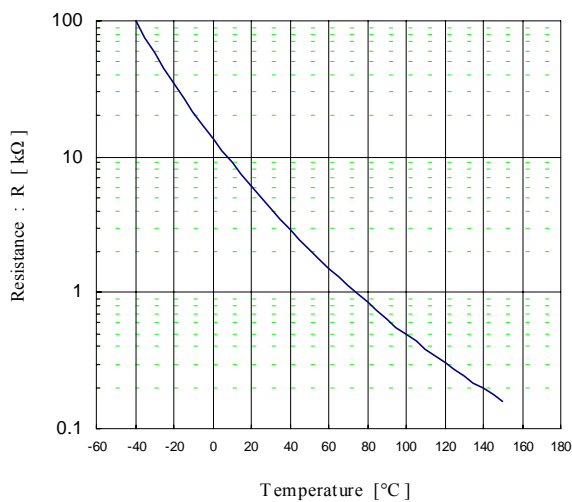

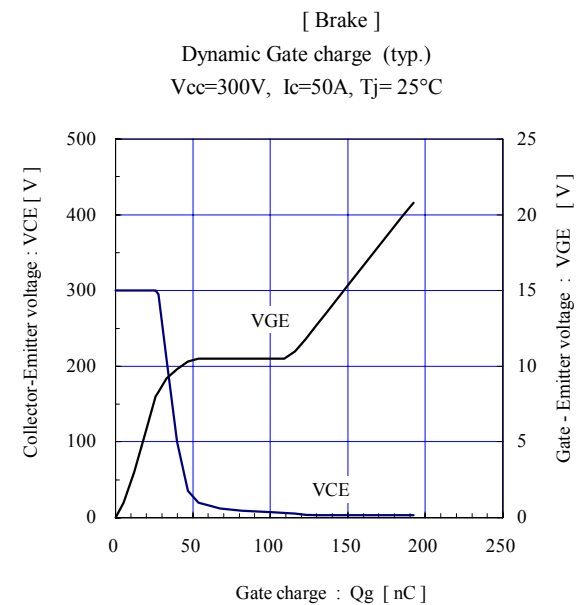
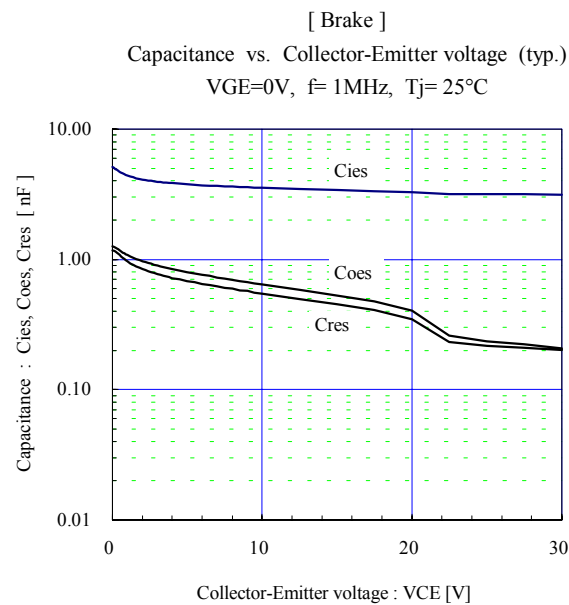
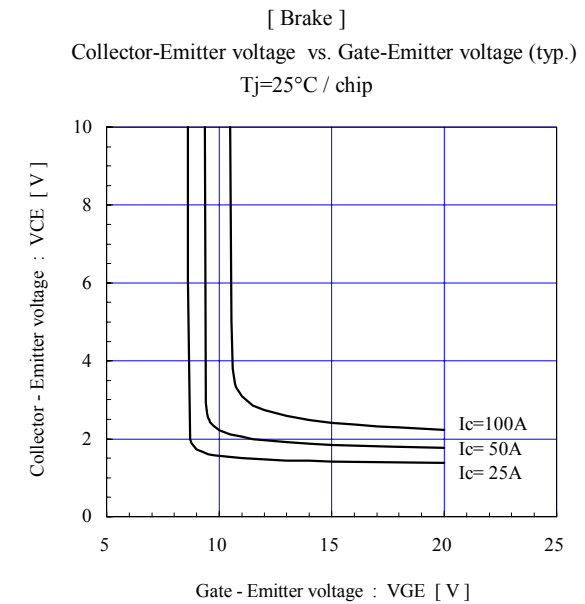
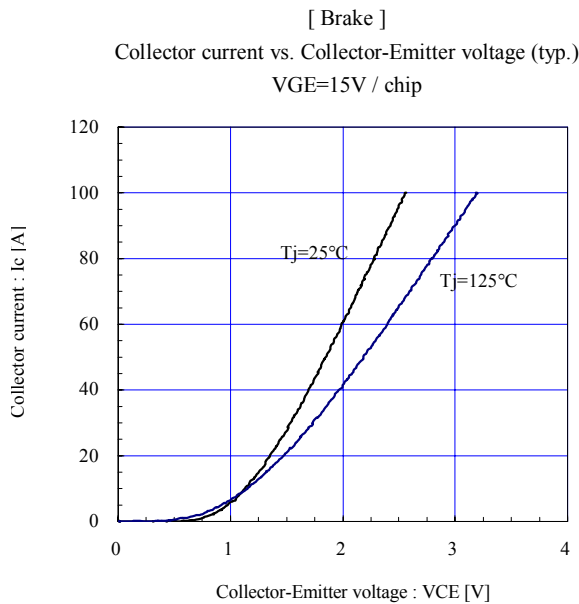
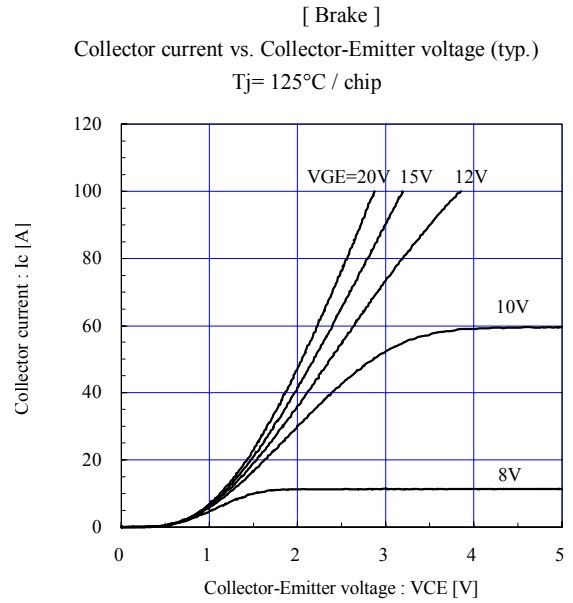
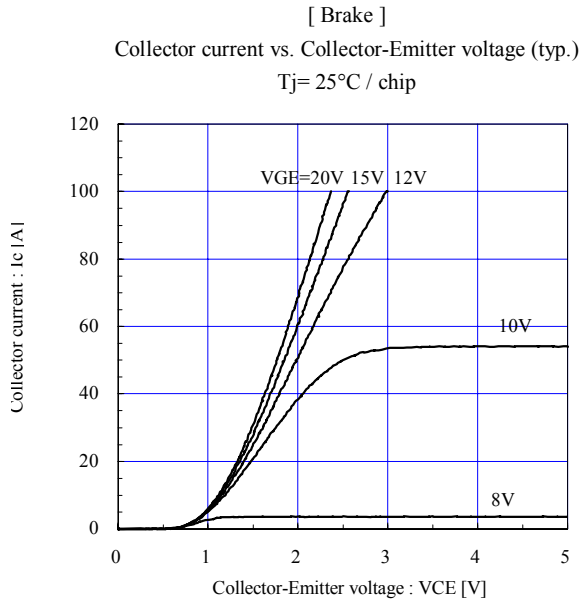

■ Outline Drawings, mm

