

20V P-CHANNEL ENHANCEMENT MODE MOSFET

SUMMARY

$V_{(BR)DSS} = -20V$; $R_{DS(ON)} = 0.090\Omega$; $I_D = -3.5A$

DESCRIPTION

This new generation of high density MOSFETs from Zetex utilises a unique structure that combines the benefits of low on-resistance with fast switching speed. This makes them ideal for high efficiency, low voltage, power management applications.

FEATURES

- Low on-resistance
- Fast switching speed
- Low threshold
- Low gate drive
- Low profile SOIC package

APPLICATIONS

- DC - DC Converters
- Power Management Functions
- Disconnect switches
- Motor control

ORDERING INFORMATION

| DEVICE | REEL SIZE (inches) | TAPE WIDTH (mm) | QUANTITY PER REEL |
|-------------|--------------------|-----------------|-------------------|
| ZXM64P02XTA | 7 | 12mm embossed | 1000 units |
| ZXM64P02XTC | 13 | 12mm embossed | 4000 units |

DEVICE MARKING

- ZXM4P02



MSOP8

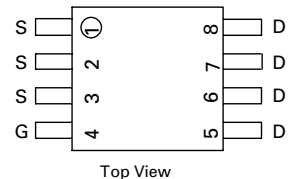
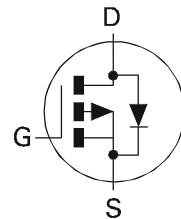

ZXM64P02X

ABSOLUTE MAXIMUM RATINGS.

| PARAMETER | SYMBOL | LIMIT | UNIT |
|---|---------------|--------------|---------------------|
| Drain-Source Voltage | V_{DSS} | -20 | V |
| Gate- Source Voltage | V_{GS} | ± 12 | V |
| Continuous Drain Current ($V_{GS}=4.5V$; $T_A=25^\circ C$)(b) ($V_{GS}=4.5V$; $T_A=70^\circ C$)(b) | I_D | -3.5 -2.8 | A |
| Pulsed Drain Current (c) | I_{DM} | -19 | A |
| Continuous Source Current (Body Diode)(b) | I_S | -2.0 | A |
| Pulsed Source Current (Body Diode)(c) | I_{SM} | -19 | A |
| Power Dissipation at $T_A=25^\circ C$ (a) Linear Derating Factor | P_D | 1.1 8.8 | W mW/ $^\circ C$ |
| Power Dissipation at $T_A=25^\circ C$ (b) Linear Derating Factor | P_D | 1.8 14.4 | W mW/ $^\circ C$ |
| Operating and Storage Temperature Range | $T_j:T_{stg}$ | -55 to +150 | $^\circ C$ |

THERMAL RESISTANCE

| PARAMETER | SYMBOL | VALUE | UNIT |
|-------------------------|-----------------|-------|--------------|
| Junction to Ambient (a) | $R_{\theta JA}$ | 113 | $^\circ C/W$ |
| Junction to Ambient (b) | $R_{\theta JA}$ | 70 | $^\circ C/W$ |

NOTES

(a) For a device surface mounted on 25mm x 25mm FR4 PCB with high coverage of single sided 1oz copper, in still air conditions

(b) For a device surface mounted on FR4 PCB measured at $t \leq 10$ secs.

(c) Repetitive rating - pulse width limited by maximum junction temperature. Refer to Transient Thermal Impedance graph.

CHARACTERISTICS

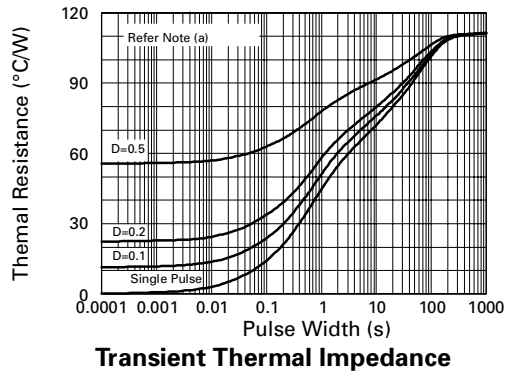
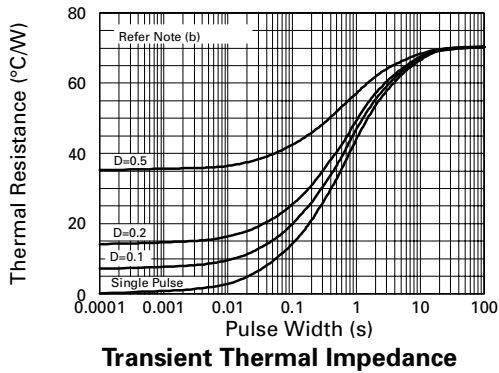
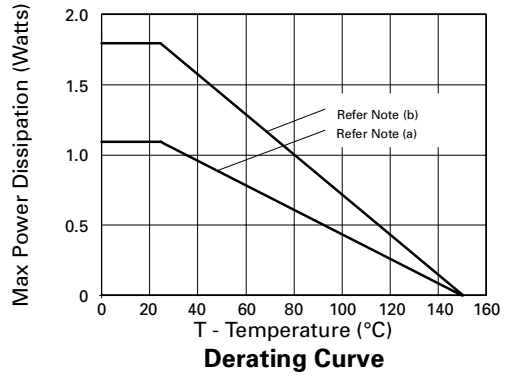
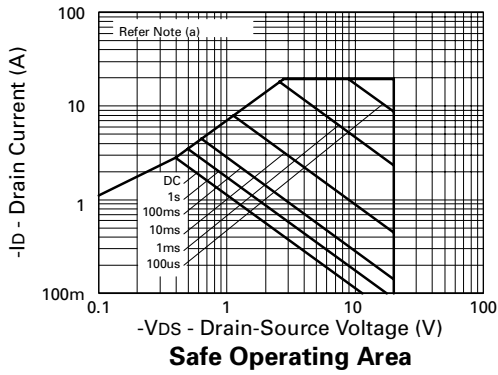

ZXM64P02X

ELECTRICAL CHARACTERISTICS (at $T_{amb} = 25^{\circ}\text{C}$ unless otherwise stated).

| PARAMETER | SYMBOL | MIN. | TYP. | MAX. | UNIT | CONDITIONS. |
|---|---------------|------|------|---------------|---------------|---|
| STATIC | | | | | | |
| Drain-Source Breakdown Voltage | $V_{(BR)DSS}$ | -20 | | | V | $I_D = -250\mu\text{A}$, $V_{GS} = 0\text{V}$ |
| Zero Gate Voltage Drain Current | I_{DSS} | | | -1 | μA | $V_{DS} = -20\text{V}$, $V_{GS} = 0\text{V}$ |
| Gate-Body Leakage | I_{GSS} | | | ± 100 | nA | $V_{GS} = \pm 12\text{V}$, $V_{DS} = 0\text{V}$ |
| Gate-Source Threshold Voltage | $V_{GS(th)}$ | -0.7 | | | V | $I_D = -250\mu\text{A}$, $V_{DS} = V_{GS}$ |
| Static Drain-Source On-State Resistance (1) | $R_{DS(on)}$ | | | 0.090 0.13 | Ω | $V_{GS} = -4.5\text{V}$, $I_D = -2.4\text{A}$ $V_{GS} = -2.7\text{V}$, $I_D = -1.2\text{A}$ |
| Forward Transconductance (3) | g_{fs} | 2.6 | | | S | $V_{DS} = -10\text{V}$, $I_D = -1.2\text{A}$ |
| DYNAMIC (3) | | | | | | |
| Input Capacitance | C_{iss} | | 900 | | pF | $V_{DS} = -15\text{V}$, $V_{GS} = 0\text{V}$, $f = 1\text{MHz}$ |
| Output Capacitance | C_{oss} | | 350 | | pF | |
| Reverse Transfer Capacitance | C_{rss} | | 150 | | pF | |
| SWITCHING(2) (3) | | | | | | |
| Turn-On Delay Time | $t_{d(on)}$ | | 5.6 | | ns | $V_{DD} = -10\text{V}$, $I_D = -2.4\text{A}$ $R_G = 6.0\Omega$, $R_D = 4.0\Omega$ (Refer to test circuit) |
| Rise Time | t_r | | 12.3 | | ns | |
| Turn-Off Delay Time | $t_{d(off)}$ | | 45.5 | | ns | |
| Fall Time | t_f | | 40.0 | | ns | $V_{DS} = -16\text{V}$, $V_{GS} = -4.5\text{V}$, $I_D = -2.4\text{A}$ (Refer to test circuit) |
| Total Gate Charge | Q_g | | | 6.9 | nC | |
| Gate-Source Charge | Q_{gs} | | | 1.3 | nC | |
| Gate Drain Charge | Q_{gd} | | | 2.5 | nC | |
| SOURCE-DRAIN DIODE | | | | | | |
| Diode Forward Voltage (1) | V_{SD} | | | -0.95 | V | $T_j = 25^{\circ}\text{C}$, $I_S = -2.4\text{A}$, $V_{GS} = 0\text{V}$ |
| Reverse Recovery Time (3) | t_{rr} | | 46.0 | | ns | $T_j = 25^{\circ}\text{C}$, $I_F = -2.4\text{A}$, $di/dt = 100\text{A}/\mu\text{s}$ |
| Reverse Recovery Charge(3) | Q_{rr} | | 35.0 | | nC | |

(1) Measured under pulsed conditions. Width=300 μs . Duty cycle $\leq 2\%$.

(2) Switching characteristics are independent of operating junction temperature.

(3) For design aid only, not subject to production testing.

TYPICAL CHARACTERISTICS

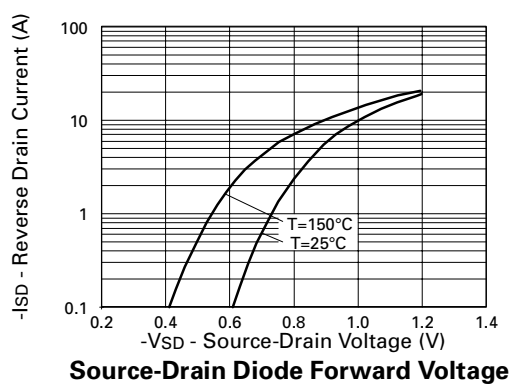
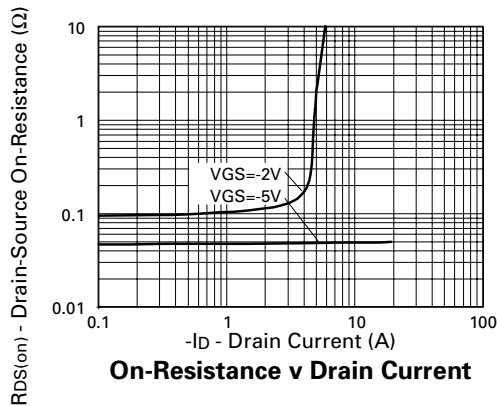
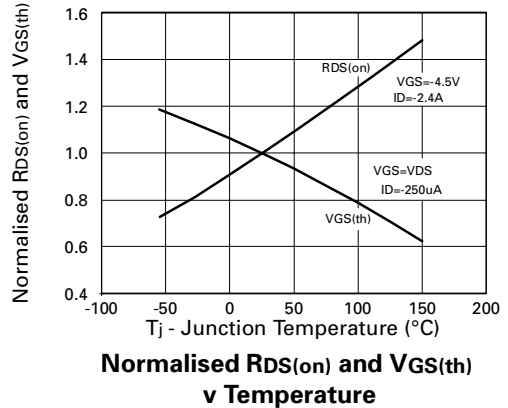
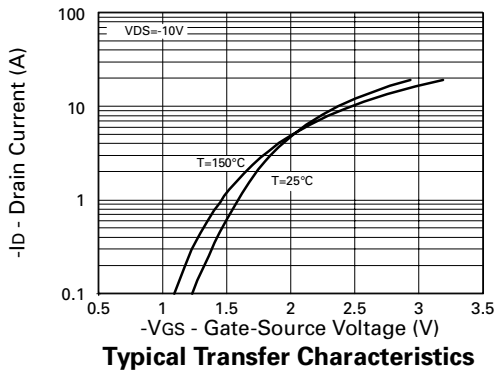
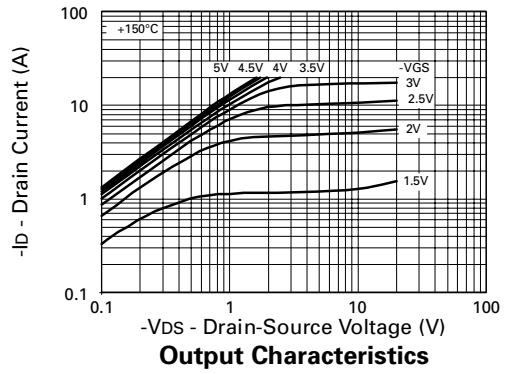
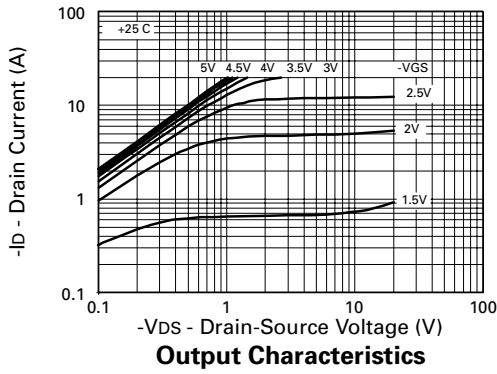

ZXM64P02X

TYPICAL CHARACTERISTICS

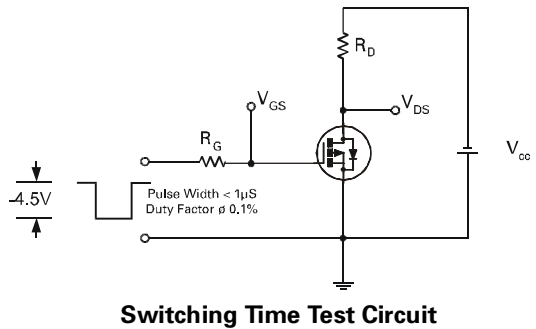
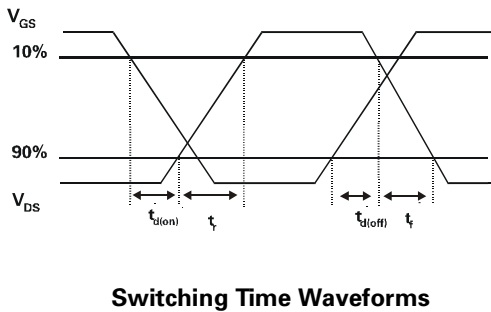
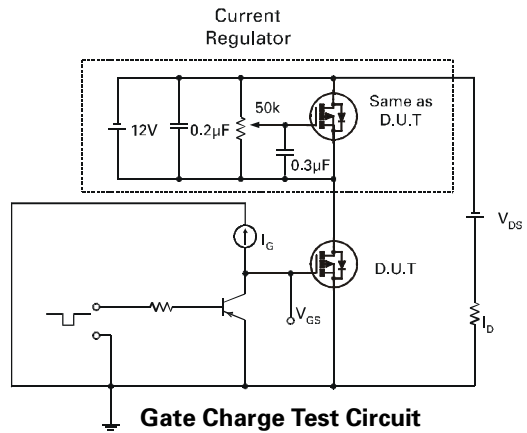
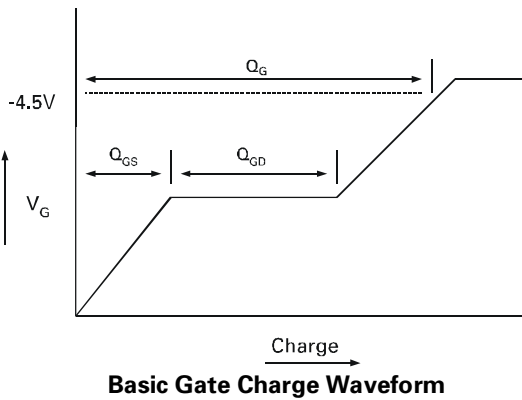
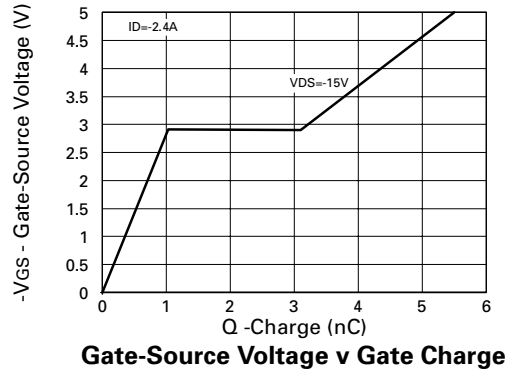
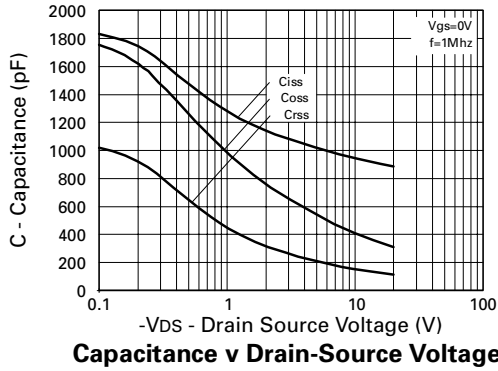

ZXM64P02X

PACKAGE DIMENSIONS

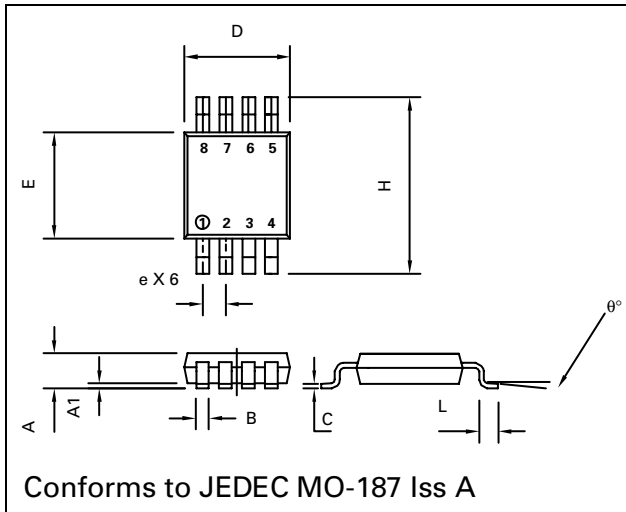

| DIM | Millimetres | | Inches | |
|-----|-------------|------|--------|-------|
| | MIN | MAX | MIN | MAX |
| A | | 1.10 | | 0.043 |
| A1 | 0.05 | 0.15 | 0.002 | 0.006 |
| B | 0.25 | 0.40 | 0.010 | 0.016 |
| C | 0.13 | 0.23 | 0.005 | 0.009 |
| D | 2.90 | 3.10 | 0.114 | 0.122 |
| e | 0.65 | BSC | 0.0256 | BSC |
| E | 2.90 | 3.10 | 0.114 | 0.122 |
| H | 4.90 | BSC | 0.193 | BSC |
| L | 0.40 | 0.70 | 0.016 | 0.028 |
| q° | 0° | 6° | 0° | 6° |

PAD LAYOUT DETAILS

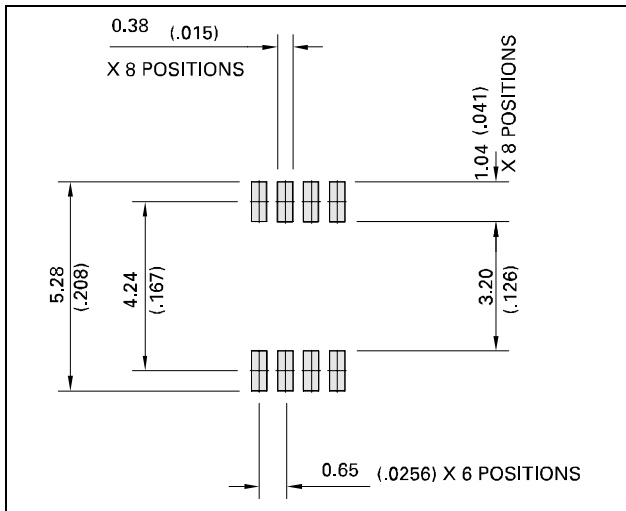

ZETEX Zetex plc.
 Fields New Road, Chadderton, Oldham, OL9-8NP, United Kingdom.
 Telephone: (44)161 622 4422 (Sales), (44)161 622 4444 (General Enquiries)
 Fax: (44)161 622 4420

Zetex GmbH
 Streitfeldstraße 19
 D-81673 München
 Germany
 Telefon: (49) 89 45 49 49 0
 Fax: (49) 89 45 49 49 49

Zetex Inc.
 47 Mall Drive, Unit 4
 Commack NY 11725
 USA
 Telephone: (516) 543-7100
 Fax: (516) 864-7630

Zetex (Asia) Ltd.
 3510 Metroplaza, Tower 2
 Hing Fong Road,
 Kwai Fong, Hong Kong
 Telephone: (852) 26100 611
 Fax: (852) 24250 494

These are supported by
 agents and distributors in
 major countries world-wide
 ©Zetex plc 1999

Internet: <http://www.zetex.com>

This publication is issued to provide outline information only which (unless agreed by the Company in writing) may not be used, applied or reproduced for any purpose or form part of any order or contract or be regarded as a representation relating to the products or services concerned. The Company reserves the right to alter without notice the specification, design, price or conditions of supply of any product or service.