

4 Channel DC/DC Converters IC with High-Efficiency Step-Up

General Description

The RT9903B is a complete power-supply solution for digital still cameras and other hand-held devices. It integrates a high-efficiency four step-up DC-DC converters and a charge pump.

The two Step-up DC-DC converters (CH1,CH2) accept inputs from 1.5V to 5.5V and regulate a resistor-adjustable output up to 17V. One Step-up DC-DC converter (CH3) can be regarded as white LED Driver, which reference voltage is 0.2V and have OVP function. One step-up DC-DC converter (CH4) regulate a resistor-adjustable output up 5V. An adjustable operating frequency (up to 1.4MHz) is utilized to get optimum size, cost, and efficiency.

RT9903B is available in VQFN-24L 4x4 package. Each DC-DC converters have independent shutdown inputs.

Applications

- Digital Still Camera
- PDAs
- Portable Device

Ordering Information

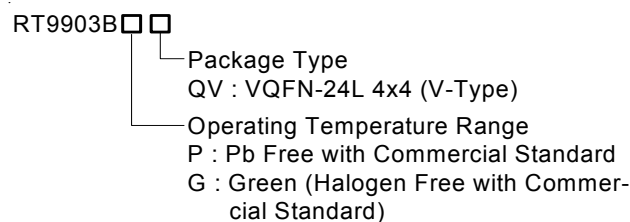

Note :

Richtek Pb-free and Green products are :

- ▶RoHS compliant and compatible with the current requirements of IPC/JEDEC J-STD-020.
- ▶Suitable for use in SnPb or Pb-free soldering processes.
- ▶100% matte tin (Sn) plating.

Marking Information

For marking information, contact our sales representative directly or through a Richtek distributor located in your area, otherwise visit our website for detail.

Features

- Two step-up DC-DC Converters (CH1, CH2)
 - ▶HV Internal Switches
 - ▶50mA Load Current
- One Step-up DC-DC Converter (CH3)
 - ▶0.2V Reference Voltage
 - ▶HV Internal Switches
 - ▶LED Brightness Dimming Control
 - ▶Over Voltage Protection
- One Step-up DC-DC Converter (CH4)
 - ▶External Switches
 - ▶External Current Limit Setting
- Up to 1.4MHz Switching Frequency
- 1µA Supply Current in Shutdown Mode
- External Compensation Network for All Converters
- Programmable Soft Start Function (CH1, CH2, CH3, CH4)
- Independent Enable Pin to Shutdown Each Channel
- 24-Lead VQFN Package
- RoHS Compliant and 100% Lead (Pb)-Free

Pin Configurations

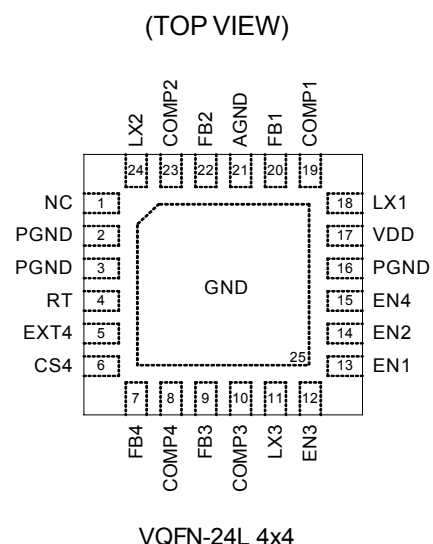

Typical Application Circuit

2-AA Battery 1.8V to 3.2V

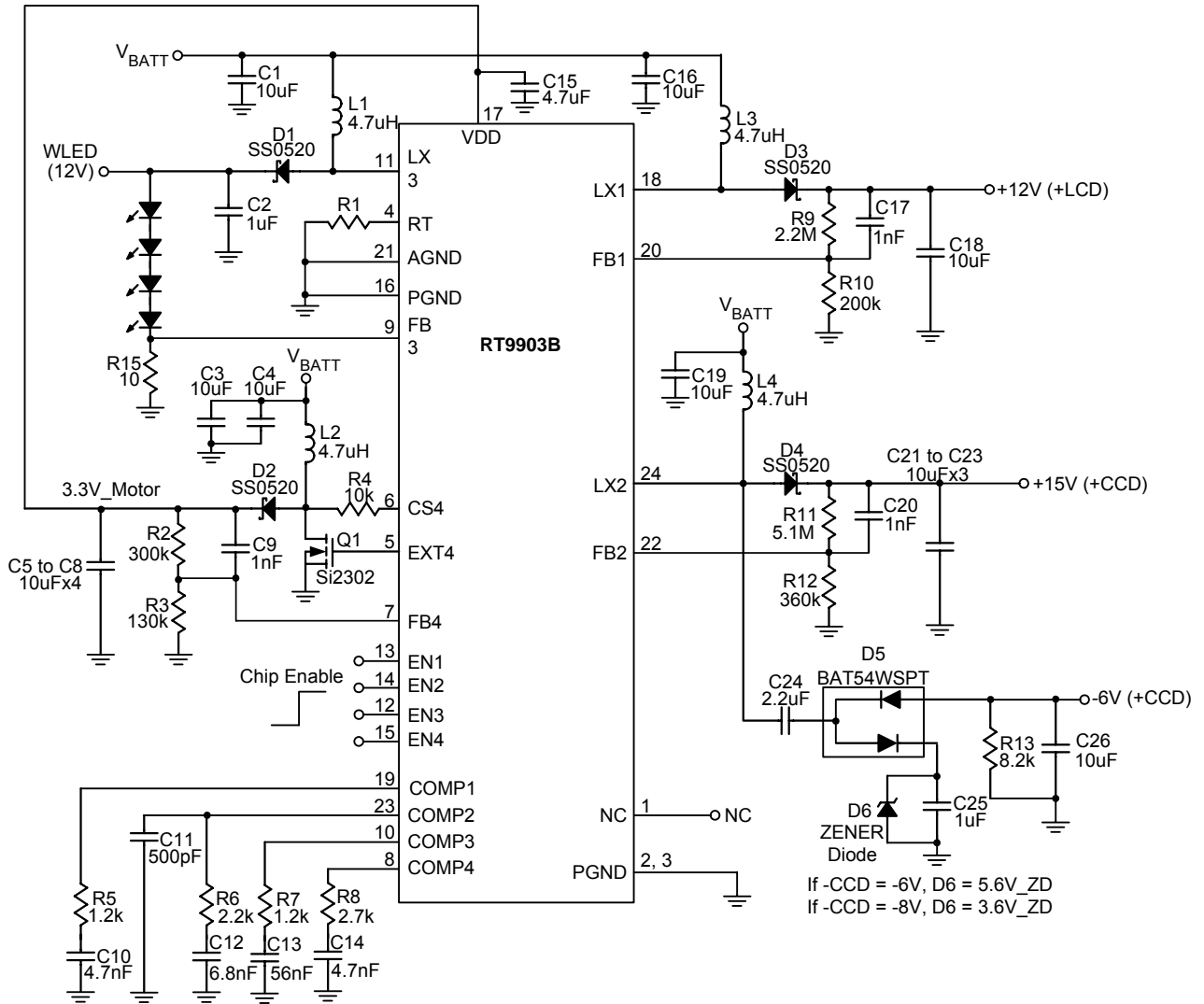

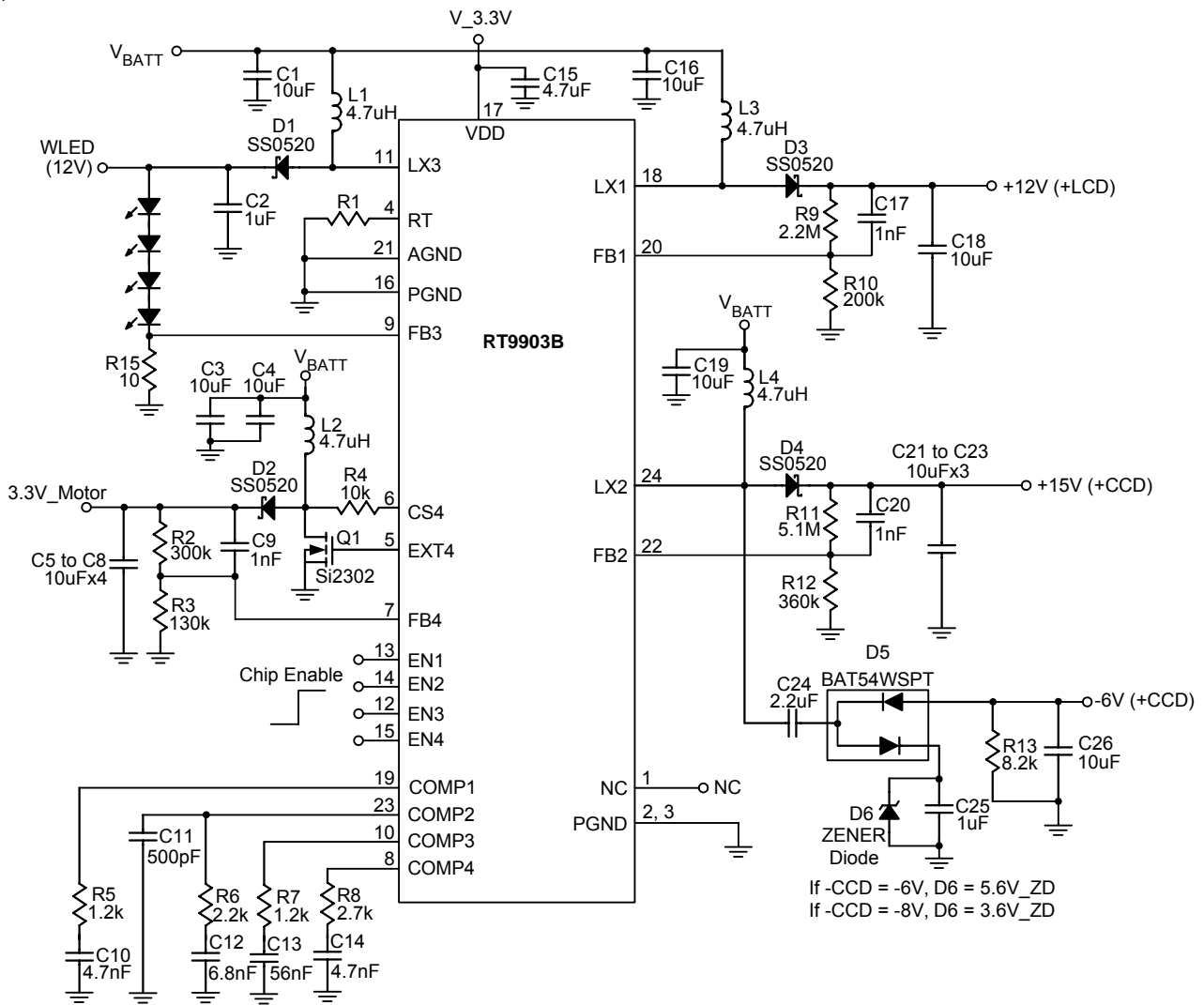

Function Block Diagram

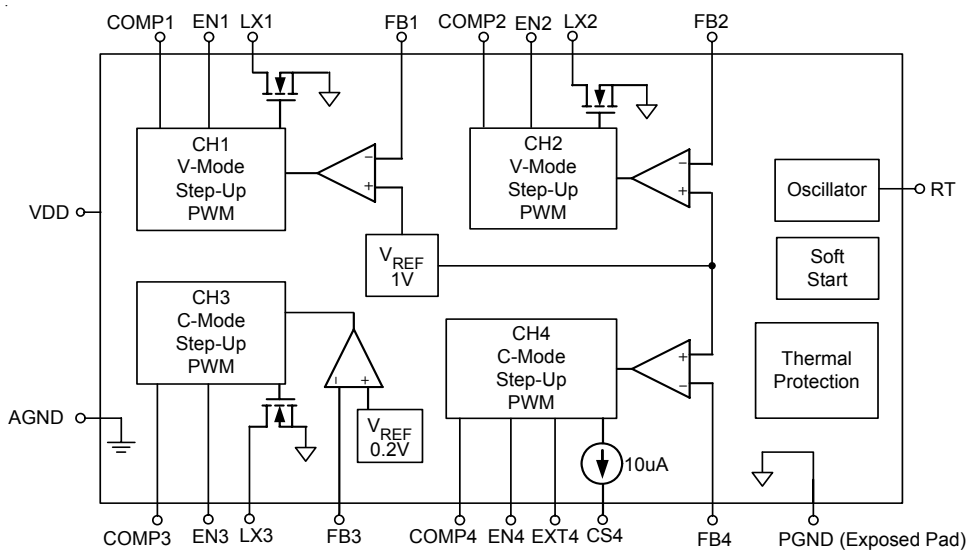

Functional Pin Description

Pin No.	Pin Name	Pin Function
1	NC	No Connection.
2	PGND	Power Ground.
3	PGND	Power Ground.
4	RT	Frequency Setting Resistor Connection Pin.
5	EXT4	CH4 External Power Switch.
6	CS4	CH4 Current Sense Input Pin.
7	FB4	CH4 Feedback Input.
8	COMP4	CH4 Feedback Compensation Pin.
9	FB3	CH3 Feedback Input.
10	COMP3	CH3 Feedback Compensation Pin.
11	LX3	CH3 Switch Node.
12	EN3	CH3 Enable Input Pin.
13	EN1	CH1 Enable Input Pin.
14	EN2	CH2 Enable Input Pin.
15	EN4	CH4 Enable Input Pin.
16	PGND	Power Ground.
17	VDD	Power Input Pin.
18	LX1	CH1 Switch Node.
19	COMP1	CH1 Feedback Compensation Pin.
20	FB1	CH1 Feedback Input.
21	AGND	Analog Ground.
22	FB2	CH2 Feedback Input.
23	COMP2	CH2 Feedback Compensation Pin.
24	LX2	CH2 Switch Node.
Exposed Pad (25)	GND	The exposed pad must be soldered to a large PCB and connected to GND for maximum power dissipation.

Absolute Maximum Ratings (Note 1)

- Supply Input Voltage (V_{DD}) ----- -0.3 to 7V
- LX1, LX2, LX3 Pins ----- -0.3V to 20V
- Other I/O Pin Voltage ----- -0.3V to 7V
- Power Dissipation, P_D @ $T_A = 25^\circ\text{C}$
 VQFN-24L 4x4 ----- 1.923W
- Package Thermal Resistance (Note 3)
 VQFN-24L 4x4, θ_{JA} ----- 52°C/W
- Lead Temperature (Soldering, 10 sec.) ----- 260°C
- Operation Temperature Range ----- -40°C to 85°C
- Junction Temperature Range ----- 0°C to 125°C
- Storage Temperature Range ----- -65°C to 150°C

Recommended Operating Conditions (Note 2)

- Maximum Output Voltage Setting (V_{OUT1} and V_{OUT2}) ----- 17V
- Dimming Control Frequency Range, CH3 ----- 200Hz to 900Hz

Electrical Characteristics

($V_{DD} = 3.3\text{V}$, $T_A = 25^\circ\text{C}$, unless otherwise specification)

Parameter	Symbol	Test Condition	Min	Typ	Max	Units
Supply Voltage						
VDD Operating Voltage	V_{VDD}	VDD Pin Voltage	2.4	--	5.5	V
VDD Start-up Voltage		VDD Pin Voltage	1.5	--	--	V
VDD Over Voltage Protection	$V_{DD(OVP)}$	VDD Pin Voltage	6	--	--	V
Supply Current						
Shutdown Supply Current	I_{OFF}	$V_{DD} = 3.6\text{V}$, V_{EN1} to 4 = 0V	--	0.01	1	μA
CH1 DC/DC Converter Supply Current	I_{VDD1}	$V_{VDD} = 3.6\text{V}$, $V_{FB1} = V_{REF} + 0.15\text{V}$ $V_{EN1} = 3.3\text{V}$, $V_{EN2} = 0\text{V}$, $V_{EN3} = 0\text{V}$, $V_{EN4} = 0\text{V}$	--	200	250	μA
CH2 DC/DC Converter Supply Current	I_{VDD2}	$V_{VDD} = 3.6\text{V}$, $V_{FB2} = V_{REF} + 0.15\text{V}$ $V_{EN1} = 0\text{V}$, $V_{EN2} = 3.3\text{V}$, $V_{EN3} = 0\text{V}$, $V_{EN4} = 0\text{V}$	--	210	260	μA
CH3 DC/DC Converter Supply Current	I_{VDD3}	$V_{VDD} = 3.6\text{V}$, $V_{FB3} = V_{REF} + 0.15\text{V}$ $V_{EN1} = 0\text{V}$, $V_{EN2} = 0\text{V}$, $V_{EN3} = 3.3\text{V}$, $V_{EN4} = 0\text{V}$	--	250	300	μA
CH4 DC/DC Converter Supply Current	I_{VDD4}	$V_{VDD} = 3.6\text{V}$, $V_{FB4} = V_{REF} + 0.15\text{V}$ $V_{EN1} = 0\text{V}$, $V_{EN2} = 0\text{V}$, $V_{EN3} = 0\text{V}$, $V_{EN4} = 3.3\text{V}$	--	200	250	μA

To be continued

Parameter	Symbol	Test Condition	Min	Typ	Max	Units
Oscillator						
Free Running Frequency	F _{OSC}	RT = Open	400	500	600	kHz
CH1, CH2, CH3 Maximum Duty Cycle	D _{MAX1,2,3}		93	95	--	%
CH4 Maximum Duty Cycle	D _{MAX4}		75	80	85	%
Reference Voltage (CH1, CH2, CH3, CH4)						
Feedback Reference Voltage	V _{FB1, 2, 4}	CH1, CH2, CH4	0.98	1	1.02	V
Feedback Reference Voltage	V _{FB3}	CH3	0.18	0.2	0.22	V
Error Amplifier						
GM		FB1 = COMP	--	200	--	μS
Compensation Source Current			--	22	--	μA
Compensation Sink Current			--	22	--	μA
Power Switch						
CH1 On Resistance of MOSFET	R _{DS1(ON)}	N-MOSFET, V _{DD} = 3.3V	--	0.6	--	Ω
CH1 Current Limitation			0.7	--	--	A
CH2 On Resistance of MOSFET	R _{DS2(ON)}	N-MOSFET, V _{DD} = 3.3V	--	0.6	--	Ω
CH2 Current Limitation			0.7	--	--	A
CH3 On Resistance of MOSFET	R _{DS3(ON)}	N-MOSFET, V _{DD} = 3.3V	--	0.6	--	Ω
CH3 Current Limitation			0.7	--	--	A
CH4 Over Current Threshold Voltage			0.3	0.4	0.5	V
CH4 On Resistance of N-MOSFET			3	6	9	Ω
CH4 On Resistance of P-MOSFET			--	20	--	Ω
Control						
EN1, EN2, EN3, EN4 Input High Level Threshold		V _{VDDM} = 3.3V	--	0.8	1.3	V
EN1, EN2, EN3, EN4 Input Low Level Threshold		V _{VDDM} = 3.3V	0.4	0.8	--	V
External Current Setting (CH4)						
CS4 Sourcing Current	I _{CS4}		8	10	12	μA
Thermal Protection						
Thermal Shutdown	T _{SD}		--	180	--	°C

Note 1. Stresses listed as the above "Absolute Maximum Ratings" may cause permanent damage to the device. These are for stress ratings. Functional operation of the device at these or any other conditions beyond those indicated in the operational sections of the specifications is not implied. Exposure to absolute maximum rating conditions for extended periods may remain possibility to affect device reliability.

Note 2. The device is not guaranteed to function outside its operating conditions.

Note 3. θ_{JA} is measured in the natural convection at T_A = 25°C on a low effective thermal conductivity test board of JEDEC 51-3 thermal measurement standard.

Note 4. Pull low EN1, EN2 and EN4 when they are not enabled. EN3 pin is automatically pulled low when not enabled.

Typical Operating Characteristics

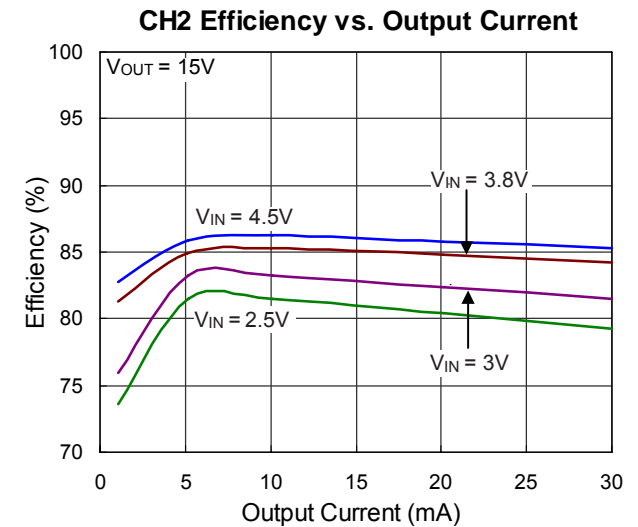
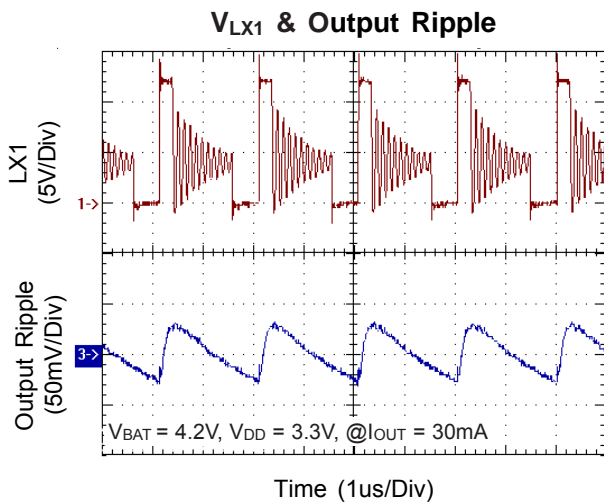
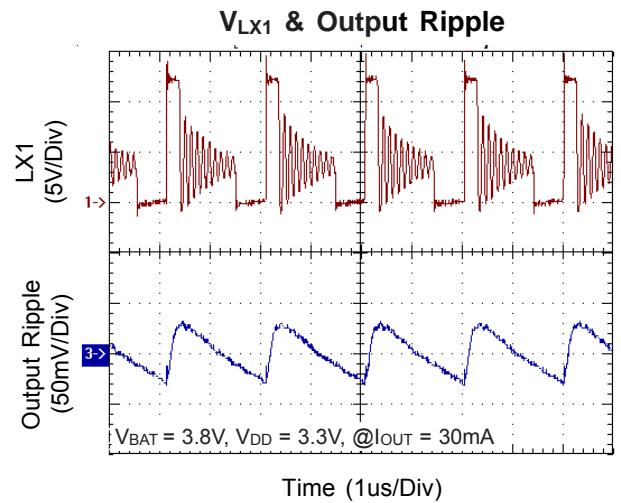
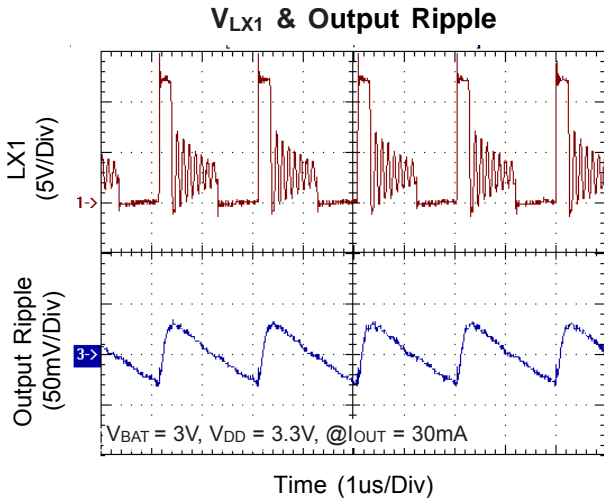
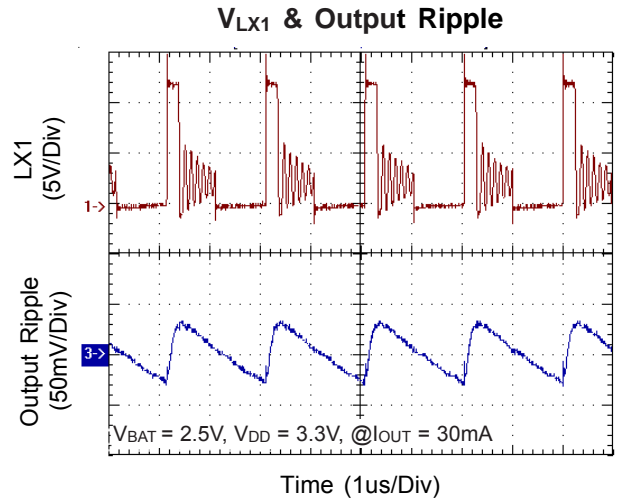
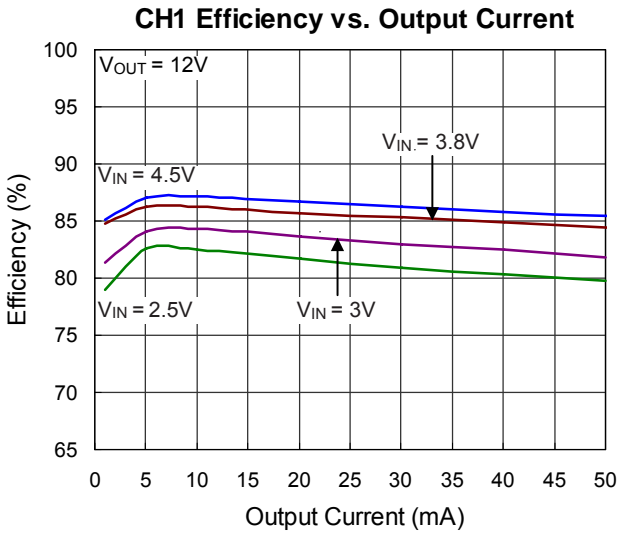

V_{LX2} & Output Ripple

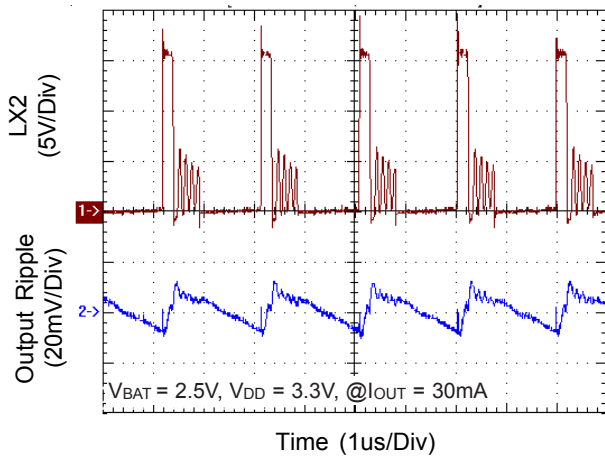

V_{LX2} & Output Ripple

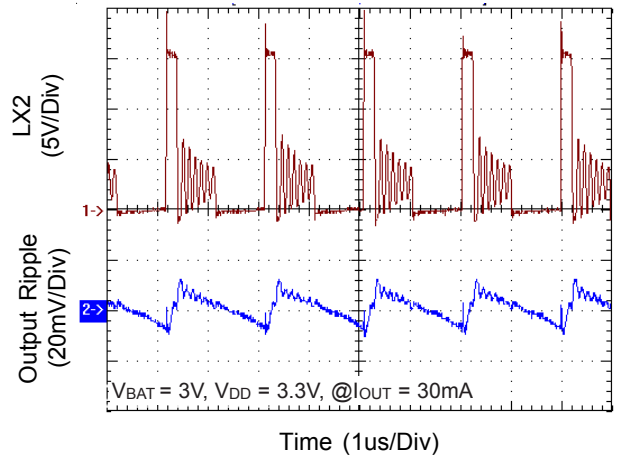

V_{LX2} & Output Ripple

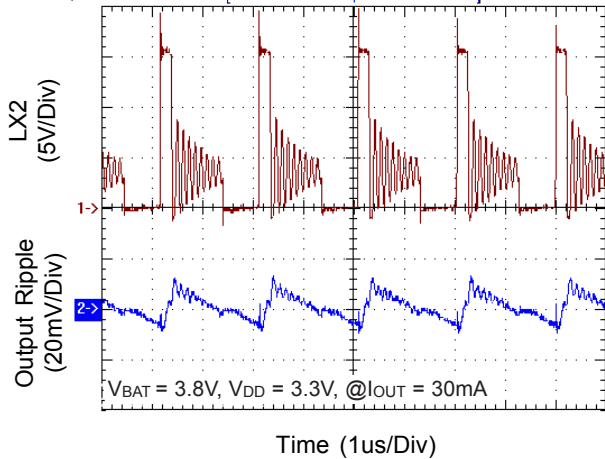

V_{LX2} & Output Ripple

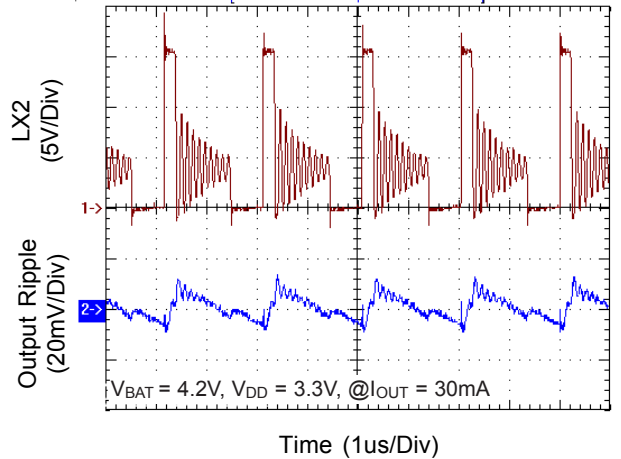

CH3 Efficiency vs. Input Voltage

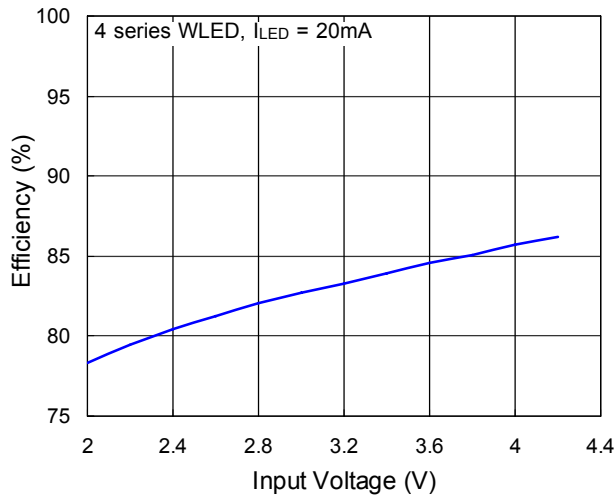

V_{LX3} & Output Ripple

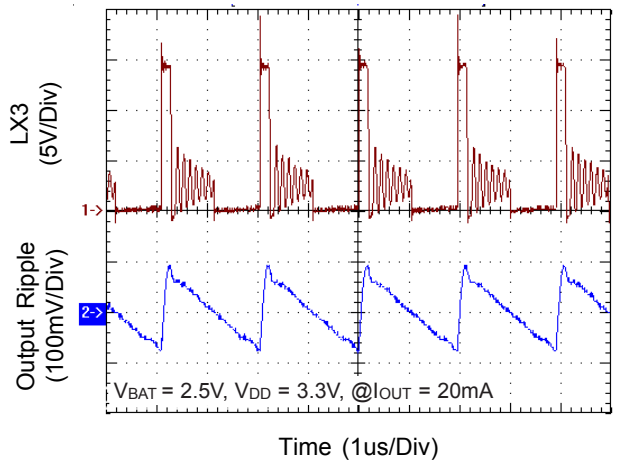

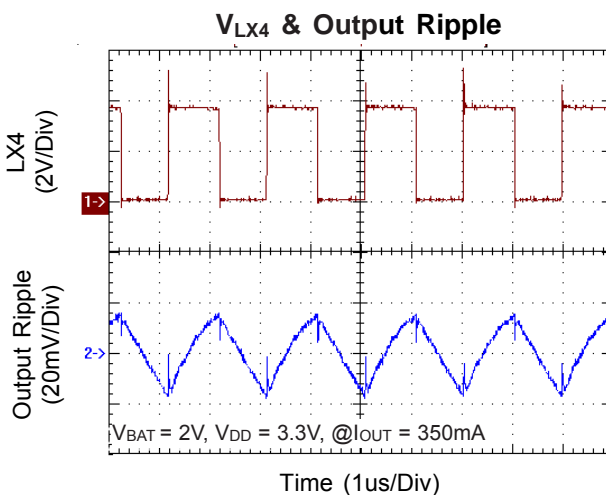
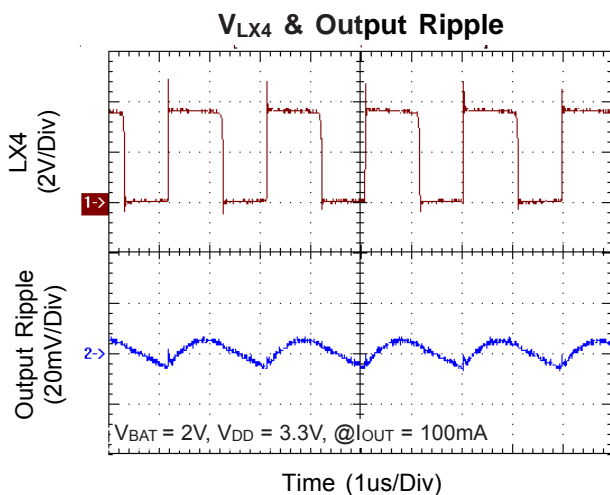
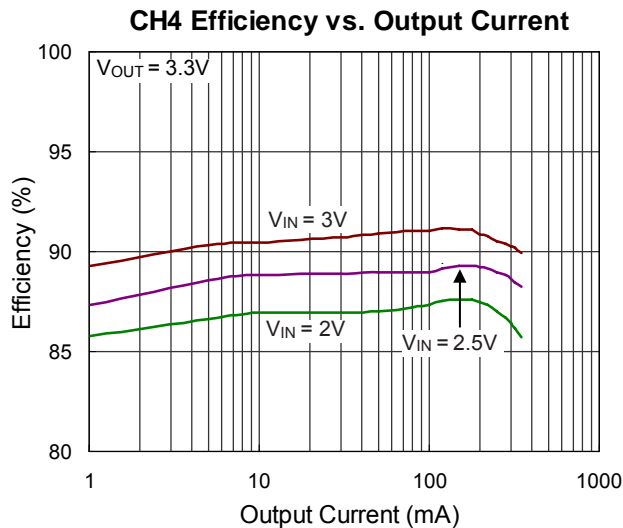
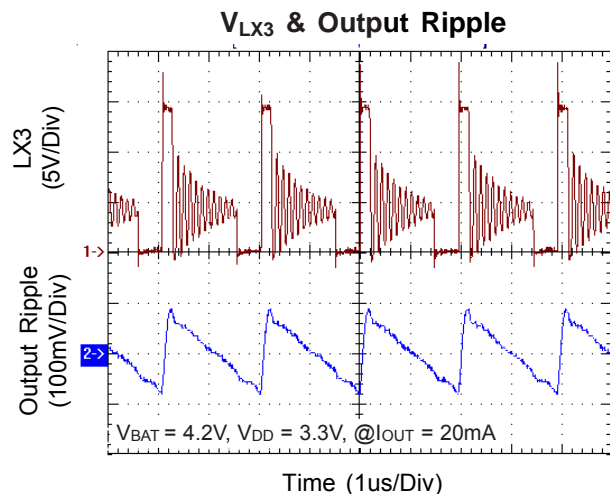
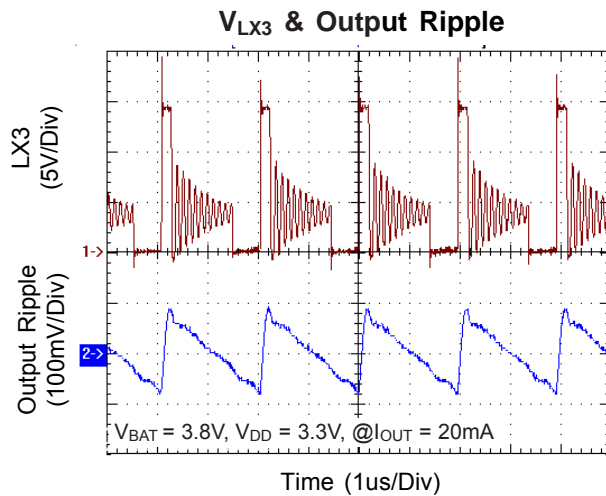
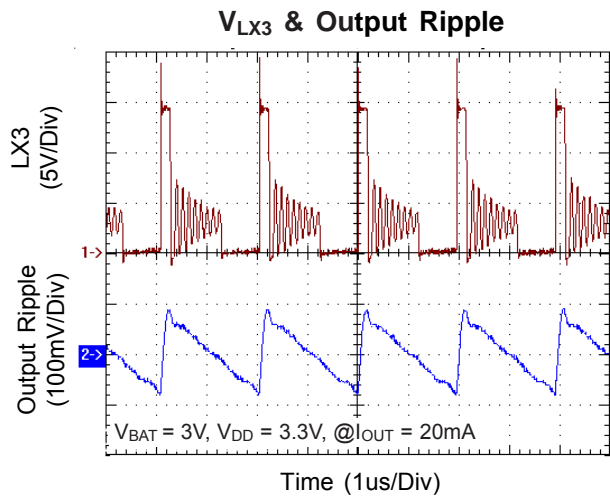

V_{LX4} & Output Ripple

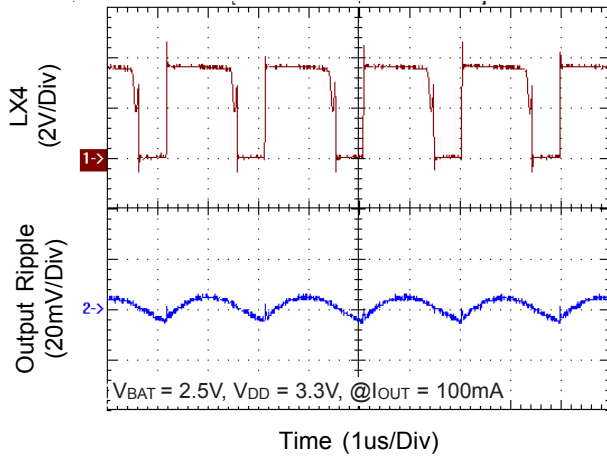

V_{LX4} & Output Ripple

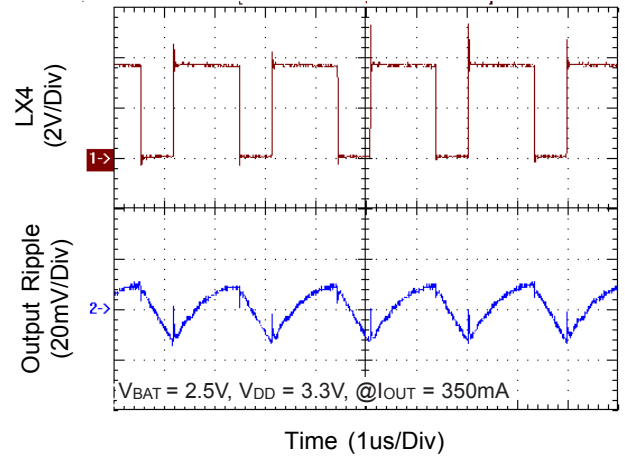

V_{LX4} & Output Ripple

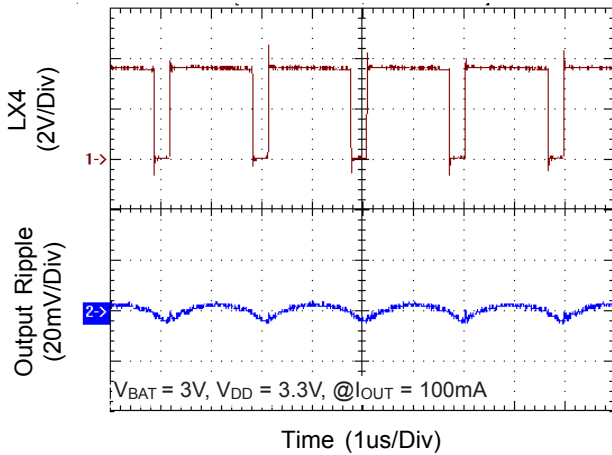

V_{LX4} & Output Ripple

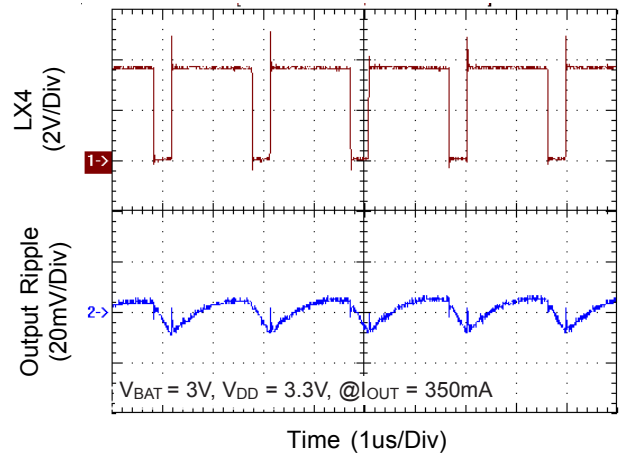

CH4 Load Transient Response

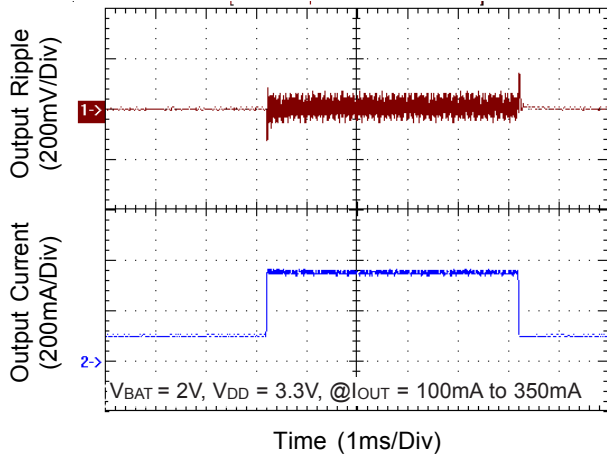

CH4 Load Transient Response

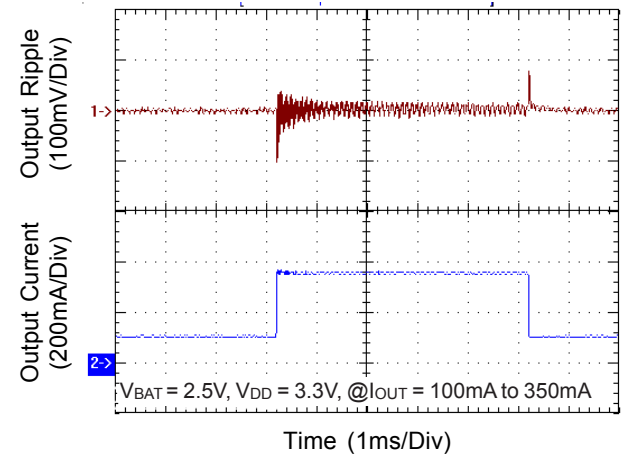

CH4 Load Transient Response

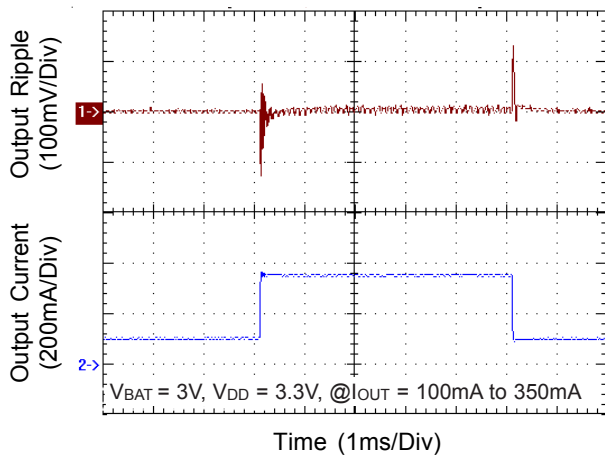

Frequency vs. R_{RT} Resistor

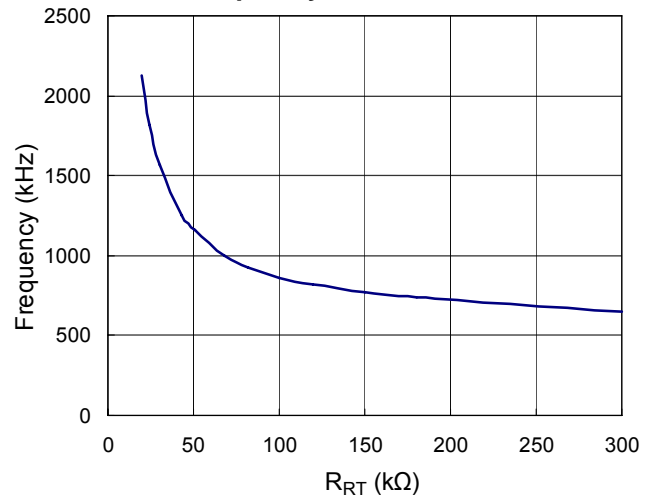

Application Information

The RT9903B is a four-Channel DC/DC converter for digital still cameras and other hand-held device. The four channels DC/DC converters are as follows:

CH1: Step-up, asynchronous voltage mode DC/DC converter with an internal power MOSFET, current limit protection, and over voltage protection. This channel is designed to supply output voltage from 3.3V to 17V.

CH2: Step-up, asynchronous voltage mode DC/DC converter with an internal power MOSFET, current limit protection, and over voltage protection. This channel is designed to supply output voltage from 3.3V to 17V.

CH3: Step-up, asynchronous current mode DC/DC converter with an internal power MOSFET, current limit protection, and over voltage protection. This channel is designed to light 2~4 WLEDs with constant current regulation, and the lightness can be dimming-controlled by the duty of EN3 pin.

CH4: Step-up, asynchronous current mode DC/DC converter with current limit protection. This channel is designed to drive external N-MOS switch for stepping-up voltage.

Soft-Start

CH1, CH2, and CH4 can be soft-started individually every time when the channel is enabled. Soft-start is achieved by ramping up the PWM duty from very small to normal operation. The ramping up PWM duty is achieved by sourcing 1uA from error amplifier to the compensation capacitor. When the output voltage is regulated, the PWM duty enters the normal operation, and the error amplifier can sink and source up to 22uA.

The soft-start time is set by the following formula:

$$T_{\text{SOFT-START}} = \frac{(1V - 1\mu A \times R_{\text{COMP}}) \times C_{\text{COMP}}}{1\mu A}$$

R_{COMP} and C_{COMP} are compensation components.

Oscillator

The internal oscillator synchronizes CH1, CH2, CH3 and CH4 PWM operation frequency. The operation frequency is set by a resistor between RT pin to ground, ranging from 500kHz to 1.4MHz.

Step-up (Boost) DC/DC Converter (CH1)

The channel (CH1) is a step-up voltage-mode DC/DC PWM converter with built-in internal power MOS and external schottky diode. Output voltage is regulated and adjustable up to 17V. This channel is designed to supply several tens mA current.

The maximum duty of the constant frequency is 96% for this channel to prevent high input current drawn from input.

Protection

Current Limit

The current of NMOS is sensed cycle by cycle to prevent over current. When over current limit, then the NMOS is off. This state is latched and then reset automatically at next clock cycle.

Over Voltage

The over voltage protection prevents LX1 voltage going too high. The over-voltage is detected by the junction leakage and the threshold value is around 22V. This channel is latched shut down when OVP occurs, and can be reset by toggling EN1.

Step-up (Boost) DC/DC Converter (CH2)

The channel (CH2) is a step-up voltage-mode DC/DC PWM converter with built-in internal power MOS and external schottky diode. Output voltage is regulated and adjustable up to 17V. This channel is designed to supply several tens mA current.

The maximum duty of the constant frequency is 96% for this channel to prevent high input current drawn from input.

Protection

Current Limit

The current of NMOS is sensed cycle by cycle to prevent over current. When over current limit, then the NMOS is off. This state is latched and then reset automatically at next clock cycle.

Over Voltage

The over voltage protection prevents LX2 voltage going too high. The over-voltage is detected by the junction leakage and the threshold value is around 22V. This channel is not latched shut down when OVP occurs.

Step-up (Boost) DC/DC Converter (CH3)

The channel (CH3) is a step-up current-mode DC/DC PWM converter with built-in internal power MOS and external schottky diode. This channel is designed to light 2 to 4 WLEDs with constant current regulation. The lightness of WLED can be dimming-controlled by the duty of EN3 pin.

The maximum duty of the constant frequency is 96% for this channel to prevent high input current drawn from input.

Protection

Current Limit

The current of NMOS is sensed cycle by cycle to prevent over current. When over current limit, then the NMOS is off. This state is latched and then reset automatically at next clock cycle.

Over Voltage

The over voltage protection prevents LX3 voltage going too high. The over-voltage is detected by the junction leakage and the threshold value is around 22V. This channel is latched shut down when OVP occurs, and can be reset by toggling EN3.

Step-up (Boost) DC/DC Converter (CH4)

The channel (CH4) is a step-up current-mode DC/DC PWM converter to drive external power N-MOS and external schottky diode.

At light load, efficiency is enhanced by pulse-skipping mode. In this mode, the external NMOS turns on by a constant pulse width. As loading increased, the converter operates at constant frequency PWM mode. The maximum duty of the constant frequency is 80% for the boost to prevent high input current drawn from input.

Protection

Current Limit

The current of NMOS is sensed cycle by cycle to prevent over current. The current is sensed by CS4 pin to determine whether it reaches current limit threshold.

When CS4 voltage is higher than 0.4V, the external NMOS is off. This state is latched and then reset automatically at next clock cycle.

$$V_{(CS4)} = 10\mu A \times R_{CS} + I_{Inductor} \times R_{DC(ON) External_MOS}$$

Current Mode Step-up Compensation

When the step-up converter operates with continuous inductor current, the right-half-plane zero (RHPZ) appears in the loop-gain frequency response. To ensure the stability, the control-loop gain should crossover at the frequency (crossover frequency f_c) much less than that of RHPZ.

The inductor (L) and output capacitance (C_{OUT}) are chosen first in consideration of performance, size, and cost. The compensation resistor(R_C) and capacitor(C_C) are then chosen to optimize the control-loop stability.

The useful steps are listed below to calculate loop compensation.

Step-1 Calculate RHPZ

For continuous conduction, the RHPZ is given by

$$f_{RHPZ} = \frac{V_{OUT} (1-D)^2}{2\pi L I_{OUT}}$$

Where D is the duty cycle = $1 - (V_{IN} / V_{OUT})$, L is the inductor value, and I_{LOAD} is the maximum output current. Typical target crossover frequency is 1/6 of RHPZ.

For example, if we assume $V_{IN} = 1.8V$, $V_{OUT} = 3.3V$, and $I_{OUT} = 0.5A$, the $R_{LOAD} = 6.6\Omega$. If we select $L = 4.7\mu H$, then : $f_{RHPZ} = 66kHz$

Step-2 Calculate C_C

Choose $f_c = 10kHz$, and then C_C is calculated from the simplified loop-gain formula.

$$\text{Loop gain} = G_m \times \frac{1 + SR_C C_C}{SC_C} \times \frac{1}{R_{CS}} \times (1-D) \times \frac{R_{OUT}}{1 + SR_{OUT} C_{OUT}} \times \frac{V_{FB}}{V_{OUT}}$$

Where G_m is the transconductance of error amplifier, and R_{CS} is the current sense amplifier transresistance.

In our design, $G_m = 200\mu S$, $R_{CS} = 0.8V/A$, and $V_{FB} = 1V$, and then $C_C = 4.34nF$ from calculation.

Choose $C_C = 4.7nF$.

Step-3 Calculate R_C

R_C is calculated such that transient droop requirements are met.

For example, in our design, if 5% transient droop is allowed, then the error amplifier moves $0.05 \times 1V$, or 50mV. The error amplifier output drives $50mV \times 200\mu S$, or 10 μA across R_C to provide transient gain.

We select $R_{CS} = 2.7k\Omega$ to meet the requirements.

The output capacitor is chosen 40 μF to cancel the $R_C C_C$ zero, and can sustain stable V_{OUT} voltage at heavy load condition.

Reference

The chip has an internal 1V reference voltage, which is the inputs of the error amplifiers of the CH1, CH2, and CH4 to compare the difference of feedback voltage. The reference voltage of CH3 is 0.2V for WLEDs application. The reference voltage can be set up stably when the supplied power (V_{DD}) is above 1.5V, and EN1 (or EN2, EN3, EN4 either one) goes high.

Thermal Protection

Thermal protection function is integrated in the chip. When the chip temperature is higher than 180°C, the controllers of all channels are shutdown. When the thermal protection is relieved, the chip operates well again.

Outline Dimension

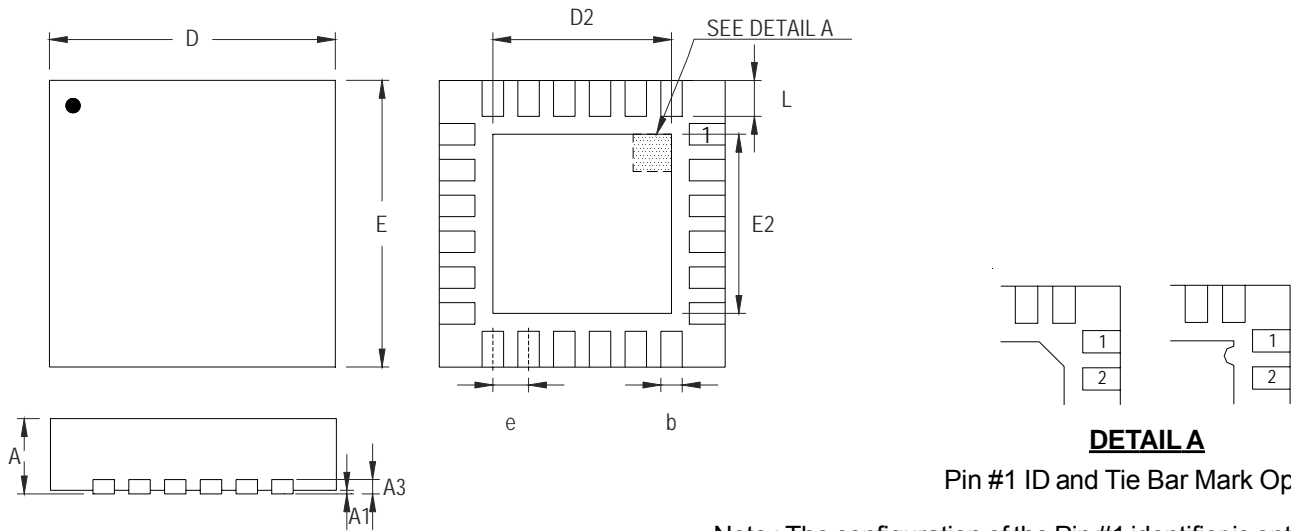

DETAIL A
Pin #1 ID and Tie Bar Mark Options

Note : The configuration of the Pin #1 identifier is optional, but must be located within the zone indicated.

Symbol	Dimensions In Millimeters		Dimensions In Inches	
	Min	Max	Min	Max
A	0.800	1.000	0.031	0.039
A1	0.000	0.050	0.000	0.002
A3	0.175	0.250	0.007	0.010
b	0.180	0.300	0.007	0.012
D	3.950	4.050	0.156	0.159
D2	2.300	2.750	0.091	0.108
E	3.950	4.050	0.156	0.159
E2	2.300	2.750	0.091	0.108
e	0.500		0.020	
L	0.350	0.450	0.014	0.018

V-Type 24L QFN 4x4 Package

Richtek Technology Corporation

Headquarter
5F, No. 20, Taiyuen Street, Chupei City
Hsinchu, Taiwan, R.O.C.
Tel: (8863)5526789 Fax: (8863)5526611

Richtek Technology Corporation

Taipei Office (Marketing)
8F, No. 137, Lane 235, Paochiao Road, Hsintien City
Taipei County, Taiwan, R.O.C.
Tel: (8862)89191466 Fax: (8862)89191465
Email: marketing@richtek.com