

ASSP for Mobile Telephone

VCO (800 to 2000 MHz)

VC-24 Series

■ DESCRIPTION

With excellent C/N characteristics and low current consumption, this VCO series is suitable for use with GSM and DCS and is ideal to miniaturize dual-band mode products. The VC-24 series can be used in any frequency band in the 800 MHz to 2000 MHz range. The device utilizes FUJITSU MEDIA DEVICE's high-frequency design technology, high-density mounting technology, and frequency adjustment technology to provide a high level of reliability in addition to high performance and small size.

■ FEATURES

- Superior noise characteristics (C/N, S/N)
- Frequency switching type
- High level of stability in response to ambient temperature and load variations
- FUJITSU MEDIA DEVICE's proprietary fabrication process provides a uniform central frequency distribution
- Small size, light-weight, slim-package : 9.3 × 7.2 × 2.0 mm (Max.)
- SMD-type taping specifications suitable for automatic mounting and reflow soldering

■ PACKAGE

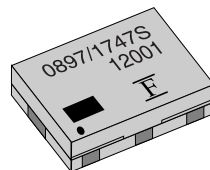

VC-24 Series

■ PIN ASSIGNMENT

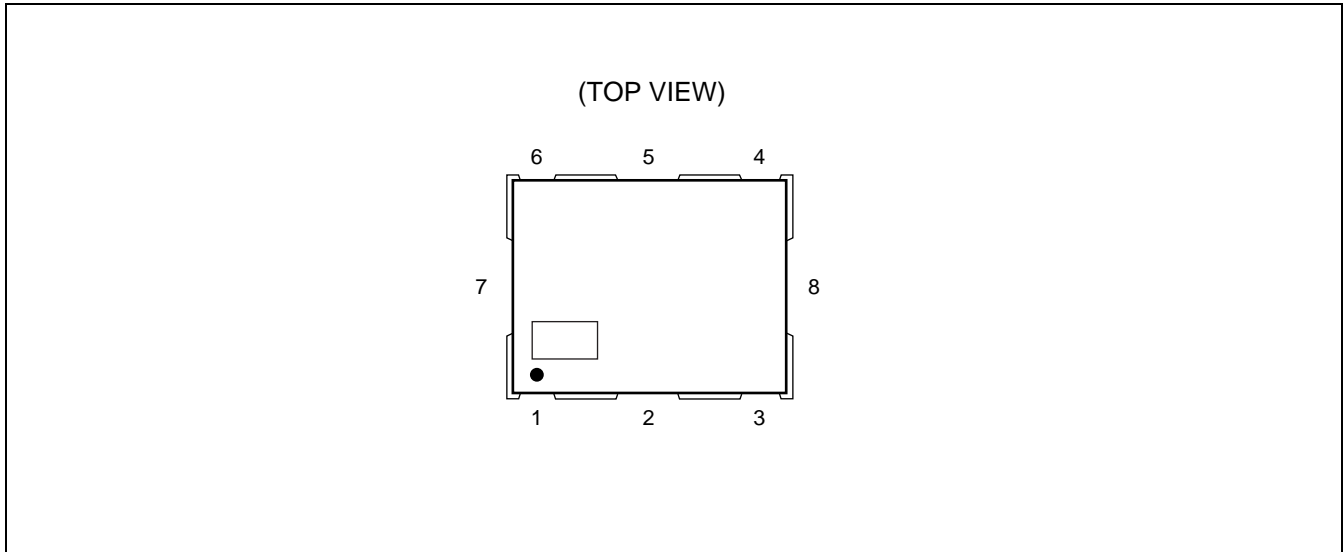

■ PIN DESCRIPTION

Pin No.	Symbol	Description
1	Vt	Control voltage
2	GND	GND
3	Vcc	Power Supply Voltage
4	OUT	Output
5	GND	GND
6	Vsw	Band select
7	GND	GND
8	GND	GND

■ PRODUCT LINEUP (STANDARD MODELS)

System		Center Frequency (MHz)	Band Width (MHz)	Power Supply Voltage (V)	Part Number
GSM/DCS	Tx	897	±17.5	2.8 ± 0.1	VC-2R8A24-0897/1747S
		1747	±37.5		
	Rx	1167	±17.5	2.8 ± 0.1	VC-2R8A24-1167/1617
		1617	±40		
	Rx	1202	±40	2.8 ± 0.1	VC-2R8A24-1202/1559P
		1559	±39		

■ ELECTRICAL CHARACTERISTICS

1. For GSM/DCS (Tx) (Part number : VC-2R8A24-0897/1747S)

• Absolute Maximum Ratings

Parameter	Symbol	Rating		Unit
		Min.	Max.	
Input DC voltage	V _{cc}	—	+3.0	V
Control voltage	V _t	—	+3.0	V
SW voltage	V _{sw}	—	+3.0	V
Operating temperature	T _a	-10	+75	°C
Storage temperature	T _{stg}	-30	+85	°C
Storage humidity	Hstg	5	95	%

WARNING: VCO can be permanently damaged by application of stress (voltage, temperature, humidity, etc.) in excess of absolute maximum ratings. Do not exceed these ratings.

• Band Selection Mode

Band Width	Selection Mode	V _{sw} (V)		Center Frequency (MHz)	Current Consumption (mA) Typ.
		Min.	Max.		
GSM	Band1	0.0	0.1	897	0.0
DCS	Band2	2.7	2.8	1747	0.5

VC-24 Series

• Electrical Characteristics

Band1

(Ta = -10°C to +75°C)

Parameter	Symbol	Conditions	Value			Unit
			Min.	Typ.	Max.	
Current consumption	I _{cc}	V _{cc} = 2.8 V, V _t = 1.35 V	—	—	38.0	mA
SW current	I _{sw}	V _{cc} = 2.8 V, V _t = 1.35 V, V _{sw} = 0 V	—	—	0.1	mA
Frequency	f _{min}	V _{cc} = 2.8 V, V _t = 0.5 V	—	—	880.0	MHz
Frequency	f _{max}	V _{cc} = 2.8 V, V _t = 2.2 V	915.0	—	—	MHz
Control voltage sensitivity	S _{vt}	(f _{max} - f _{min}) / 1.7	32.0	38.0	44.0	MHz/V
Oscillator output	P _o	V _{cc} = 2.8 V, V _t = 1.35 V	5.5	8.5	11.5	dBm
C/N	C/N	V _{cc} = 2.8 V, V _t = 1.35 V, Offset = 10 kHz, BW = 1 Hz	—	—	-93.0	dBc/Hz
		V _{cc} = 2.8 V, V _t = 1.35 V, Offset = 400 kHz, BW = 1 Hz	—	—	-123.0	dBc/Hz
		V _{cc} = 2.8 V, V _t = 1.35 V, Offset = 10 MHz, BW = 1 Hz	—	—	-153.0	dBc/Hz
		V _{cc} = 2.8 V, V _t = 1.35 V, Offset = 20 MHz, BW = 1 Hz	—	—	-162.0	dBc/Hz
Higher harmonics	H _s	V _{cc} = 2.8 V, V _t = 1.35 V, Up to 3rd	—	—	-10.0	dBc
Power supply variation	Push	V _{cc} = 2.8 V ± 0.1 V, V _t = 1.35 V	—	—	±1000	kHz
Load variation	Pull	V _{cc} = 2.8 V, V _t = 1.35 V, VSWR = 2, All phases	—	—	±2000	kHz
Temperature drift	T _d	V _{cc} = 2.8 V, V _t = 1.35 V	—	—	±3000	kHz

VC-24 Series

Band2

(Ta = -10°C to +75°C)

Parameter	Symbol	Conditions	Value			Unit
			Min.	Typ.	Max.	
Current consumption	I _{cc}	V _{cc} = 2.8 V, V _t = 1.35 V	—	—	38.0	mA
SW current	I _{sw}	V _{cc} = 2.8 V, V _t = 1.35 V, V _{sw} = 2.8 V	—	—	1.0	mA
Frequency	f _{min}	V _{cc} = 2.8 V, V _t = 0.5 V	—	—	1710.0	MHz
Frequency	f _{max}	V _{cc} = 2.8 V, V _t = 2.2 V	1785.0	—	—	MHz
Control voltage sensitivity	S _{vt}	(f _{max} – f _{min}) / 1.7	57.0	67.0	77.0	MHz/V
Oscillator output	P _o	V _{cc} = 2.8 V, V _t = 1.35 V	4.5	7.5	10.5	dBm
C/N	C/N	V _{cc} = 2.8 V, V _t = 1.35 V, Offset = 10 kHz, BW = 1 Hz	—	—	-90.0	dBc/Hz
		V _{cc} = 2.8 V, V _t = 1.35 V, Offset = 400 kHz, BW = 1 Hz	—	—	-120.0	dBc/Hz
		V _{cc} = 2.8 V, V _t = 1.35 V, Offset = 10 MHz, BW = 1 Hz	—	—	-150.0	dBc/Hz
		V _{cc} = 2.8 V, V _t = 1.35 V, Offset = 20 MHz, BW = 1 Hz	—	—	-157.0	dBc/Hz
Higher harmonics	H _s	V _{cc} = 2.8 V, V _t = 1.35 V, Up to 3rd	—	—	-10.0	dBc
Power supply variation	Push	V _{cc} = 2.8 V ± 0.1 V, V _t = 1.35 V	—	—	±2000	kHz
Load variation	Pull	V _{cc} = 2.8 V, V _t = 1.35 V, VSWR = 2, All phases	—	—	±4000	kHz
Temperature drift	T _d	V _{cc} = 2.8 V, V _t = 1.35 V	—	—	±5000	kHz

VC-24 Series

2. For GSM/DCS (Rx) (Part number : VC-2R8A24-1167/1617)

• Absolute Maximum Ratings

Parameter	Symbol	Rating		Unit
		Min.	Max.	
Input DC voltage	V _{CC}	—	+3.0	V
Control voltage	V _t	—	+3.0	V
SW voltage	V _{SW}	—	+3.0	V
Operating temperature	T _a	-10	+75	°C
Storage temperature	T _{stg}	-30	+85	°C
Storage humidity	H _{stg}	5	95	%

WARNING: VCO can be permanently damaged by application of stress (voltage, temperature, humidity, etc.) in excess of absolute maximum ratings. Do not exceed these ratings.

• Band Selection Mode

Band Width	Selection Mode	V _{sw} (V)		Center Frequency (MHz)	Current Consumption (mA) Typ.
		Min.	Max.		
GSM	Band1	0.0	0.1	1167	0.0
DCS	Band2	2.7	2.8	1617	0.5

• Electrical Characteristics

Band1

(T_a = -10°C to +75°C)

Parameter	Symbol	Conditions	Value			Unit
			Min.	Typ.	Max.	
Current consumption	I _{CC}	V _{CC} = 2.8 V, V _t = 1.35 V	—	—	10.0	mA
SW current	I _{SW}	V _{CC} = 2.8 V, V _t = 1.35 V, V _{SW} = 0 V	—	—	0.1	mA
Frequency	f _{min}	V _{CC} = 2.8 V, V _t = 0.5 V	—	—	1150.0	MHz
Frequency	f _{max}	V _{CC} = 2.8 V, V _t = 2.2 V	1185.0	—	—	MHz
Control voltage sensitivity	S _{vt}	(f _{max} - f _{min}) / 1.7	29.0	36.0	43.0	MHz/V
Oscillator output	P _o	V _{CC} = 2.8 V, V _t = 1.35 V	-6.0	-2.0	2.0	dBm
C/N	C/N	V _{CC} = 2.8 V, V _t = 1.35 V, Offset = 10 kHz, BW = 1 Hz	—	—	-85.0	dBc/Hz
		V _{CC} = 2.8 V, V _t = 1.35 V, Offset = 600 kHz, BW = 1 Hz	—	—	-123.0	dBc/Hz
		V _{CC} = 2.8 V, V _t = 1.35 V, Offset = 1.6 MHz, BW = 1 Hz	—	—	-133.0	dBc/Hz
		V _{CC} = 2.8 V, V _t = 1.35 V, Offset = 3 MHz, BW = 1 Hz	—	—	-142.0	dBc/Hz
Higher harmonics	H _s	V _{CC} = 2.8 V, V _t = 1.35 V	—	—	-10.0	dBc
Power supply variation	Push	V _{CC} = 2.8 V ± 0.1 V, V _t = 1.35 V	—	—	±1000	kHz
Load variation	Pull	V _{CC} = 2.8 V, V _t = 1.35 V, V _{SWR} = 2, All phases	—	—	±1500	kHz
Temperature drift	T _d	V _{CC} = 2.8 V, V _t = 1.35 V	—	—	±3000	kHz

VC-24 Series

Band2

(Ta = -10°C to +75°C)

Parameter	Symbol	Conditions	Value			Unit
			Min.	Typ.	Max.	
Current consumption	I _{cc}	V _{cc} = 2.8 V, V _t = 1.35 V	—	—	10.0	mA
SW current	I _{sw}	V _{cc} = 2.8 V, V _t = 1.35 V, V _{sw} = 2.8 V	—	—	1.0	mA
Frequency	f _{min}	V _{cc} = 2.8 V, V _t = 0.5 V	—	—	1577.5	MHz
Frequency	f _{max}	V _{cc} = 2.8 V, V _t = 2.2 V	1657.5	—	—	MHz
Control voltage sensitivity	S _{vt}	(f _{max} - f _{min}) / 1.7	56.0	66.0	76.0	MHz/V
Oscillator output	P _o	V _{cc} = 2.8 V, V _t = 1.35 V	-6.0	-2.0	+2.0	dBm
C/N	C/N	V _{cc} = 2.8 V, V _t = 1.35 V, Offset = 10 kHz, BW = 1 Hz	—	—	-85.0	dBc/Hz
		V _{cc} = 2.8 V, V _t = 1.35 V, Offset = 400 kHz, BW = 1 Hz	—	—	-123.0	dBc/Hz
		V _{cc} = 2.8 V, V _t = 1.35 V, Offset = 10 MHz, BW = 1 Hz	—	—	-133.0	dBc/Hz
		V _{cc} = 2.8 V, V _t = 1.35 V, Offset = 20 MHz, BW = 1 Hz	—	—	-140.0	dBc/Hz
Higher harmonics	H _s	V _{cc} = 2.8 V, V _t = 1.35 V, Up to 3rd	—	—	-10.0	dBc
Power supply variation	Push	V _{cc} = 2.8 V ± 0.1 V, V _t = 1.35 V	—	—	±1500	kHz
Load variation	Pull	V _{cc} = 2.8 V, V _t = 1.35 V, VSWR = 2, All phases	—	—	±2000	kHz
Temperature drift	T _d	V _{cc} = 2.8 V, V _t = 1.35 V	—	—	±5000	kHz

VC-24 Series

3. For GSM/DCS (Rx) (Part number : VC-2R8A24-1202/1559P)

• Absolute Maximum Ratings

Parameter	Symbol	Rating		Unit
		Min.	Max.	
Input DC voltage	V _{CC}	0.0	+3.0	V
Control voltage	V _t	0.0	+2.5	V
SW voltage	V _{SW}	0.0	+3.0	V
Operating temperature	T _a	-20	+75	°C
Storage temperature	T _{stg}	-35	+85	°C
Storage humidity	H _{stg}	5	95	%

WARNING: VCO can be permanently damaged by application of stress (voltage, temperature, humidity, etc.) in excess of absolute maximum ratings. Do not exceed these ratings.

• Band Selection Mode

Band Width	Selection Mode	V _{sw} (V)		Center Frequency (MHz)	Current Consumption (mA) Typ.
		Min.	Max.		
GSM	Band1	0.0	0.3	1202	0.0
DCS	Band2	2.5	2.8	1559	0.4

• Electrical Characteristics

Band1

(T_a = -20°C to +75°C)

Parameter	Symbol	Conditions	Value			Unit
			Min.	Typ.	Max.	
Current consumption	I _{CC}	V _{CC} = 2.8 V, V _t = 1.5 V	—	—	9.0	mA
SW current	I _{SW}	V _{CC} = 2.8 V, V _t = 1.5 V, V _{SW} = 0 V	—	—	0.1	mA
Frequency	f _{min}	V _{CC} = 2.8 V, V _t = 0.8 V	—	—	1162.0	MHz
Frequency	f _{max}	V _{CC} = 2.8 V, V _t = 2.2 V	1242.0	—	—	MHz
Control voltage sensitivity	S _v	(f _{max} - f _{min}) / 1.4	66.0	76.0	86.0	MHz/V
Oscillator output	P _o	V _{CC} = 2.8 V, V _t = 1.5 V	-5.0	-2.0	1.0	dBm
C/N	C/N	V _{CC} = 2.8 V, V _t = 1.5 V, Offset = 10 kHz, BW = 1 Hz	85.0	—	—	dBc/Hz
		V _{CC} = 2.8 V, V _t = 1.5 V, Offset = 3000 kHz, BW = 1 Hz	140.0	—	—	dBc/Hz
Higher harmonics	H _s	V _{CC} = 2.8 V, V _t = 1.5 V, Up to 3rd	—	—	-10.0	dBc
Spurious	S _p	V _{CC} = 2.8 V, V _t = 1.5 V, Offset = 3 MHz (Min.)	—	—	-87.0	dBc
Power supply variation	Push	V _{CC} = 2.8 V ± 0.1 V, V _t = 1.5 V	—	—	±1000	kHz
Load variation	Pull	V _{CC} = 2.8 V, V _t = 1.5 V, VSWR = 2, All phases	—	—	±2000	kHz

VC-24 Series

Band2

(Ta = -20°C to +75°C)

Parameter	Symbol	Conditions	Value			Unit
			Min.	Typ.	Max.	
Current consumption	I _{CC}	V _{CC} = 2.8 V, V _t = 1.5 V	—	—	10.5	mA
SW current	I _{SW}	V _{CC} = 2.8 V, V _t = 1.5 V, V _{SW} = 2.8 V	—	—	1.0	mA
Frequency	f _{min}	V _{CC} = 2.8 V, V _t = 0.8 V	—	—	1520.0	MHz
Frequency	f _{max}	V _{CC} = 2.8 V, V _t = 2.2 V	1598.0	—	—	MHz
Control voltage sensitivity	S _{vt}	(f _{max} – f _{min}) / 1.4	88.0	98.0	108.0	MHz/V
Oscillator output	P _o	V _{CC} = 2.8 V, V _t = 1.5 V	-6.0	-2.0	2.0	dBm
C/N	C/N	V _{CC} = 2.8 V, V _t = 1.5 V, Offset = 10 kHz, BW = 1 Hz	85.0	—	—	dBc/Hz
		V _{CC} = 2.8 V, V _t = 1.5 V, Offset = 3000 kHz, BW = 1 Hz	135.0	—	—	dBc/Hz
Higher harmonics	H _s	V _{CC} = 2.8 V, V _t = 1.5 V, 2nd, 3rd	—	—	-10.0	dBc
Spurious	S _p	V _{CC} = 2.8 V, V _t = 1.5 V, Offset = 3 MHz (Min.)	—	—	-82.0	dBc
Power supply variation	Push	V _{CC} = 2.8 V ± 0.1 V, V _t = 1.5 V	—	—	±1000	kHz
Load variation	Pull	V _{CC} = 2.8 V, V _t = 1.5 V, VSWR = 2, All phases	—	—	±2000	kHz

VC-24 Series

MARKING

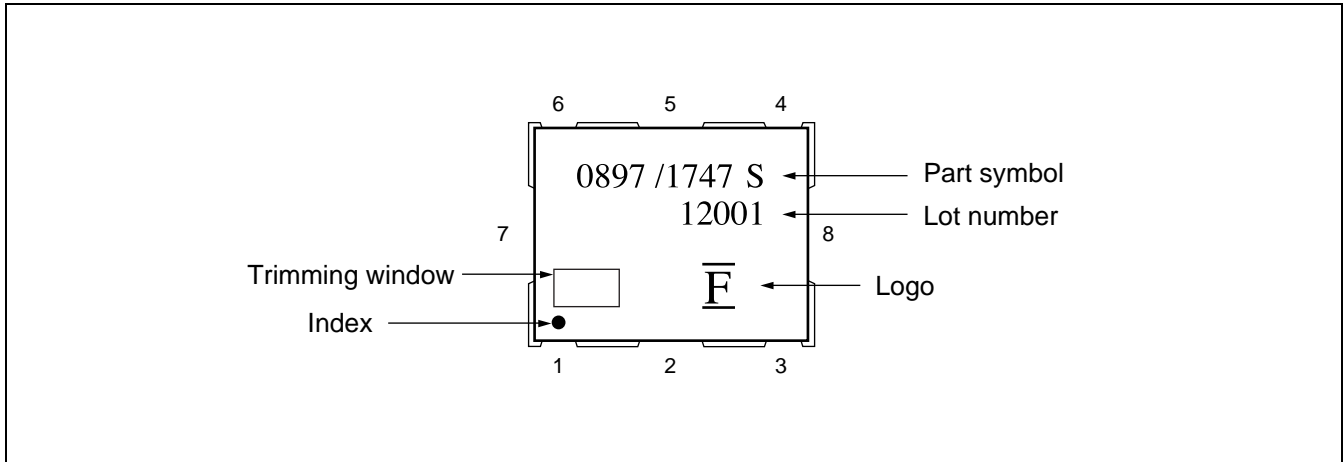

PART NUMBER DESIGNATION

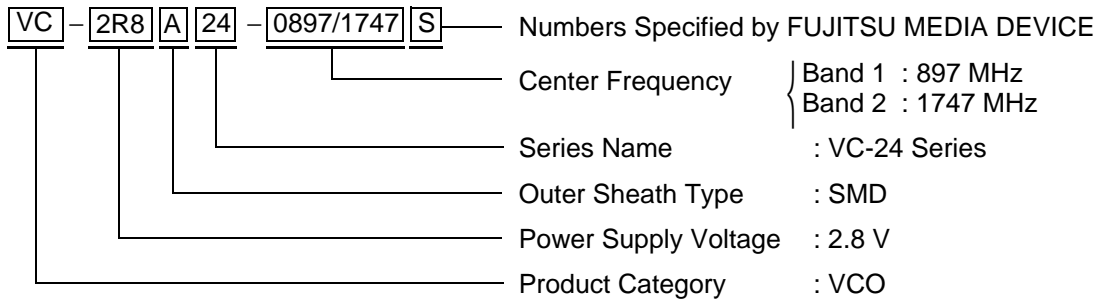

■ PACKAGE DIMENSION

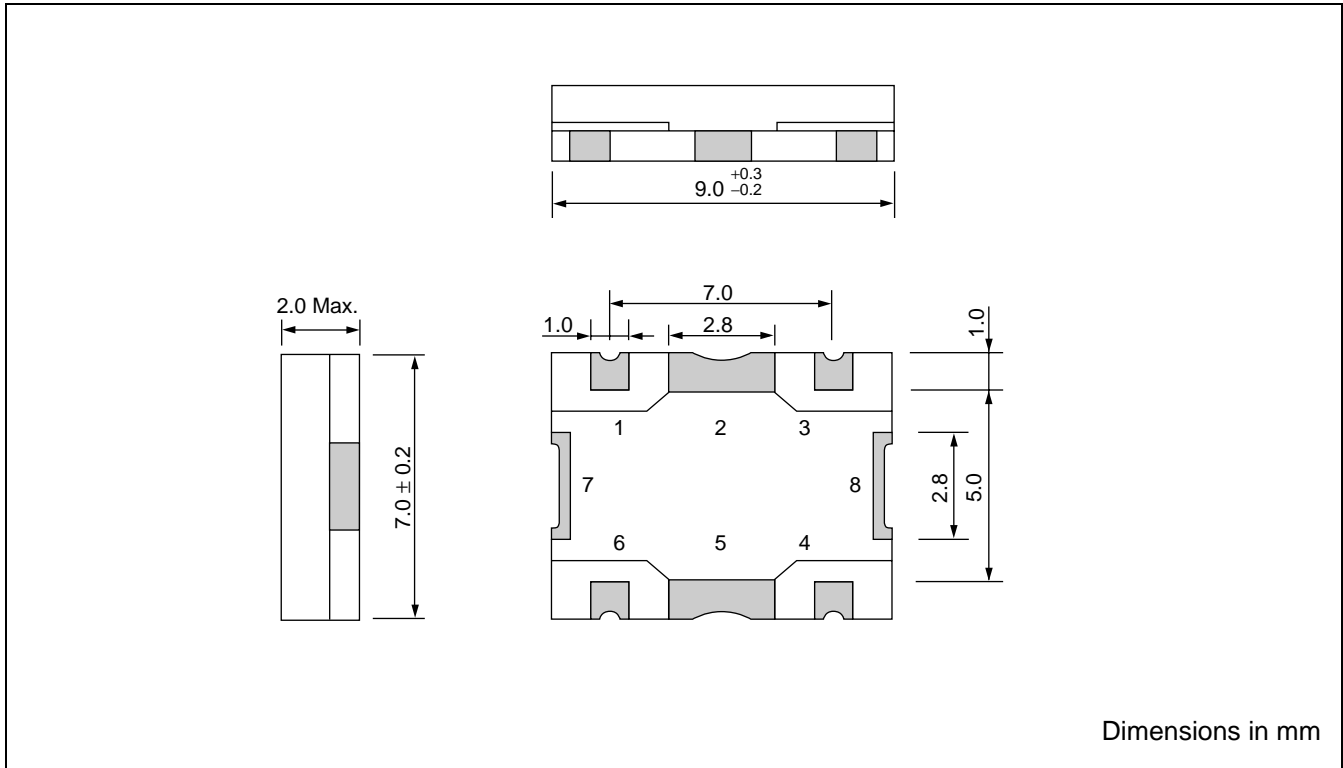

■ RECOMMENDED PATTERN FOR SOLDERING

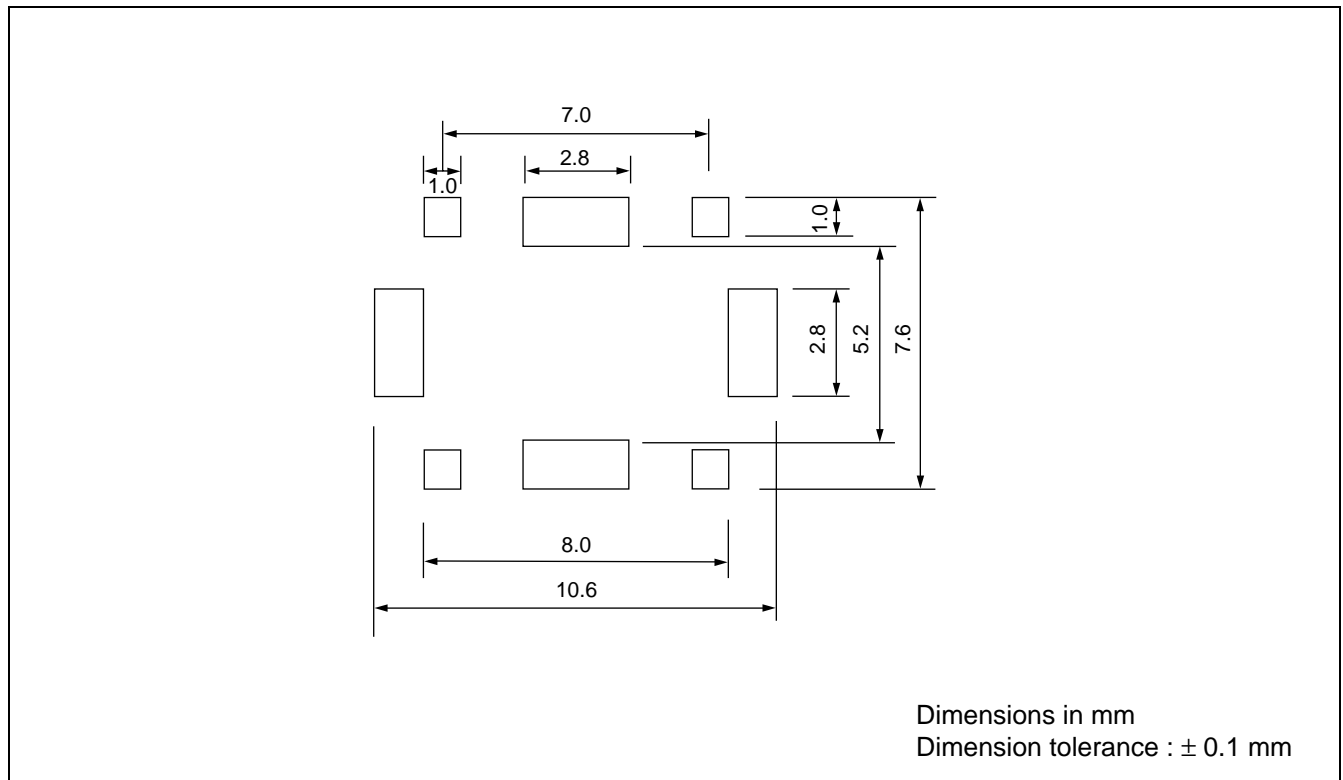

VC-24 Series

■ TAPING AND PACKAGING

(1) Carrier Tape and Packaging

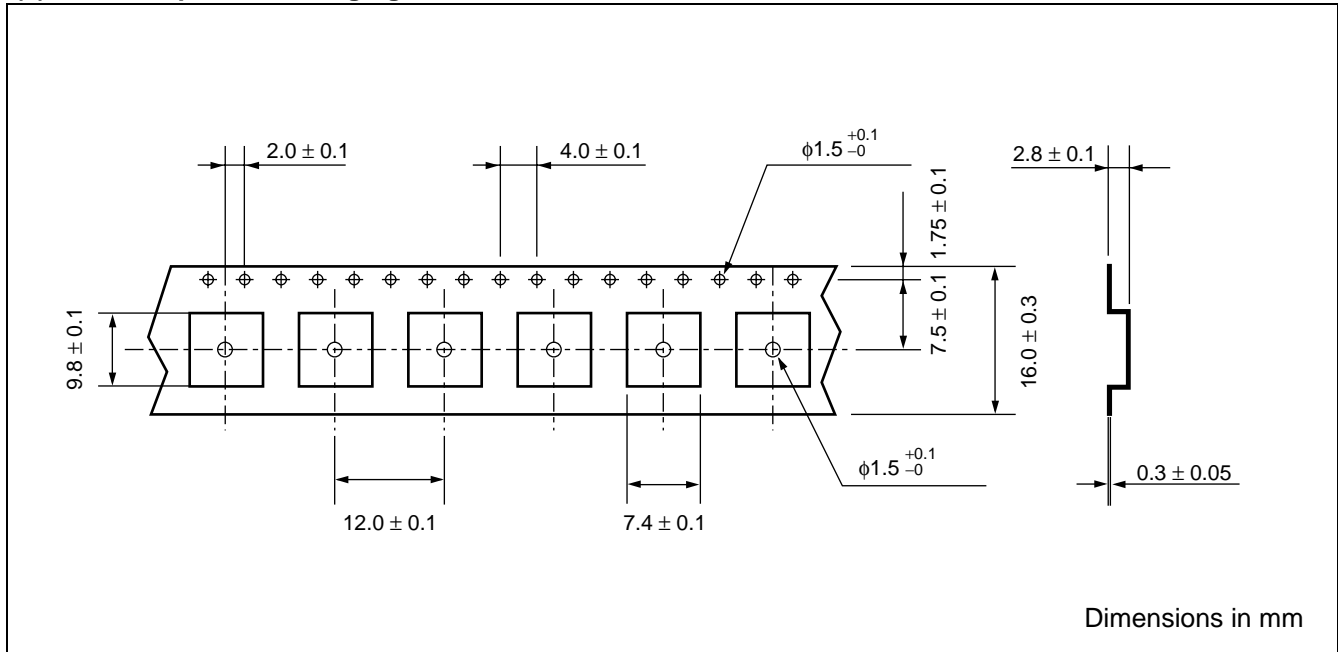

(2) Taping Layout

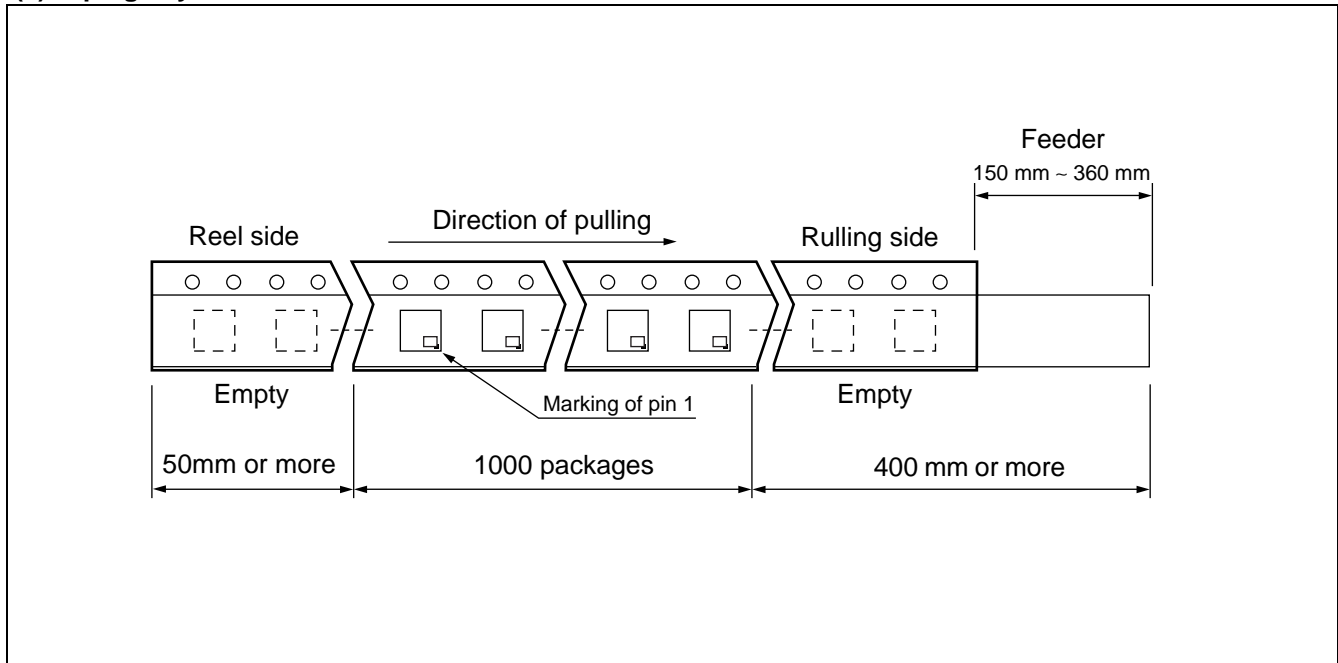

(3) Reel Shape and Dimensions

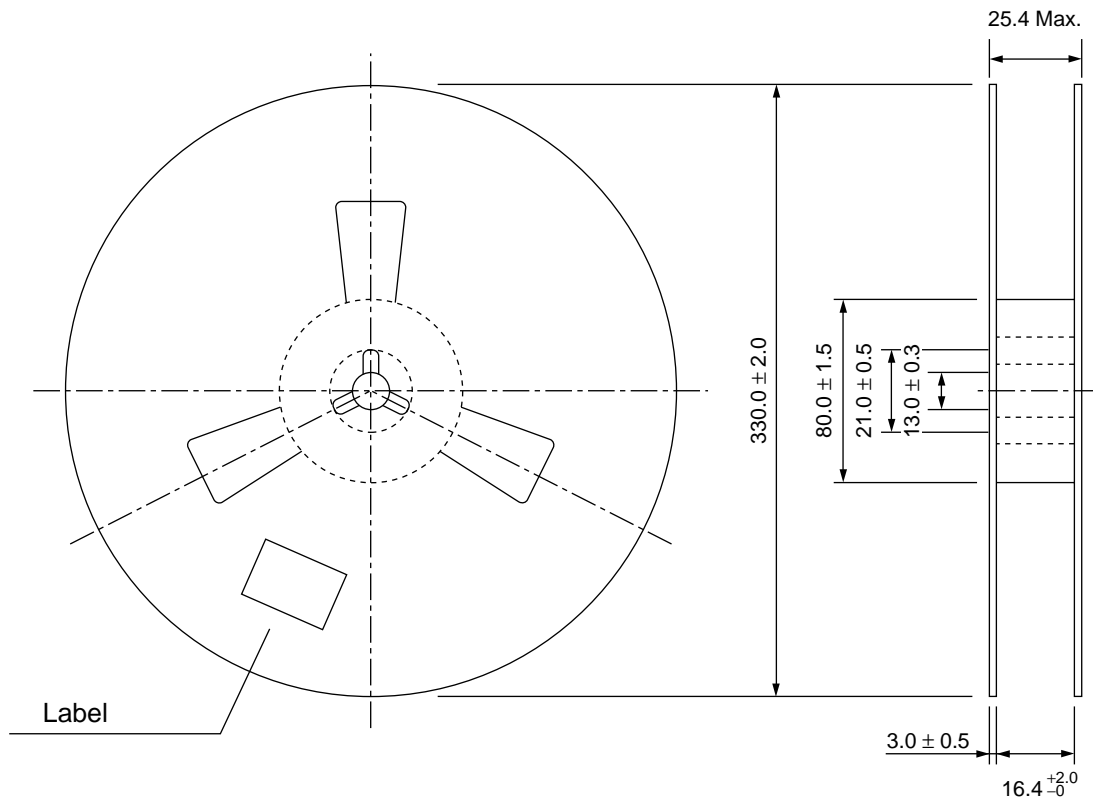

Note : The label specifies the part number, quantity, and lot number.

Volume : 1000 pcs/reel
 Type : (L) $340 \times$ (W) $340 \times$ (t) 30 (mm)

Dimensions in mm

VC-24 Series

REFLOW MOUNTING CONDITIONS (RECOMMENDED)

- Perform mounting using the temperature profile shown below. To prevent thermal stress to the VCO, ensure gentle temperature gradients and use preheating whenever possible.
- Always consult FUJITSU MEDIA DEVICE beforehand if mounting more than once.
- Never remove a VCO that has already been mounted and attempt to reuse.
- For mounting, use a general-purpose flux suitable for mounting electronic components.

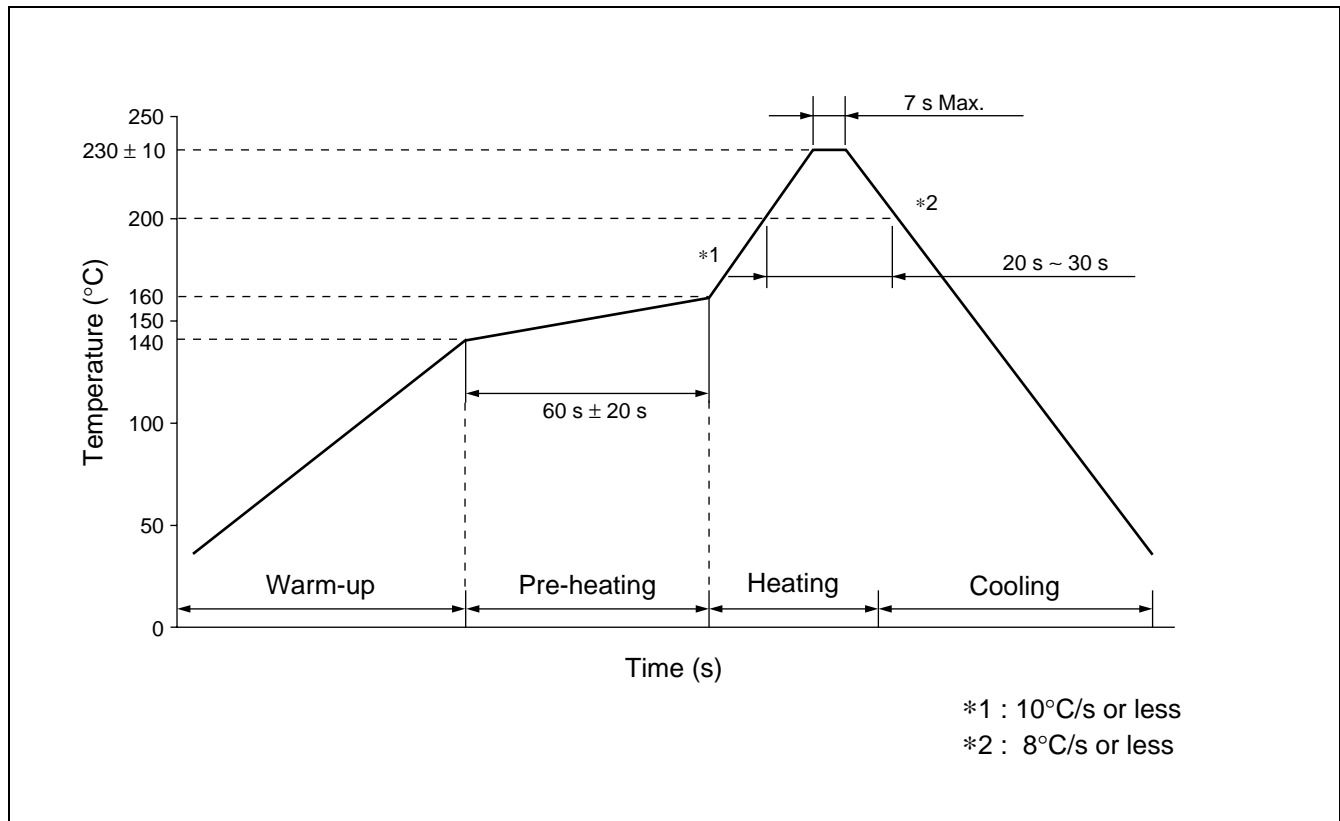

WASHING CONDITIONS

- Washing solution: Use isopropyl alcohol.
- Washing procedure: Immersion or steam cleaning is recommended.
- Washing time: For immersion: Less than 5 minutes at 40°C or less.
For steam: Less than 2 minutes at 90°C or less is recommended.

FUJITSU MEDIA DEVICES LIMITED

For further information please contact:

Japan

FUJITSU MEDIA DEVICE LIMITED
International SalesMarketing DEPT.
Shin-Yokohama Square Bldg.,14F,
Shin-yokohama 2-3-12,
Kohoku-ku, Yokohama,
Kanagawa 222-0033, Japan
Tel: +81-45-471-0061
Fax: +81-45-471-0076

<http://www.fujitsu.co.jp/hypertext/fmd/English/index.html>

North and South America

FUJITSU MICROELECTRONICS, INC.
3545 North First Street,
San Jose, CA 95134-1804, U.S.A.
Tel: +1-408-922-9000
Fax: +1-408-922-9179

Customer Response Center
Mon. - Fri.: 7 am - 5 pm (PST)
Tel: +1-800-866-8608
Fax: +1-408-922-9179

<http://www.fujitsumicro.com/>

Europe

FUJITSU MICROELECTRONICS EUROPE GmbH
Am Siebenstein 6-10,
D-63303 Dreieich-Buchsschlag,
Germany
Tel: +49-6103-690-0
Fax: +49-6103-690-122

<http://www.fujitsu-fme.com/>

Asia Pacific

FUJITSU MICROELECTRONICS ASIA PTE. LTD.
#05-08, 151 Lorong Chuan,
New Tech Park,
Singapore 556741
Tel: +65-281-0770
Fax: +65-281-0220

<http://www.fmap.com.sg/>

F0101

© FUJITSU LIMITED Printed in Japan

All Rights Reserved.

The contents of this document are subject to change without notice. Customers are advised to consult with FUJITSU sales representatives before ordering.

The information and circuit diagrams in this document are presented as examples of semiconductor device applications, and are not intended to be incorporated in devices for actual use. Also, FUJITSU is unable to assume responsibility for infringement of any patent rights or other rights of third parties arising from the use of this information or circuit diagrams.

The contents of this document may not be reproduced or copied without the permission of FUJITSU LIMITED.

FUJITSU semiconductor devices are intended for use in standard applications (computers, office automation and other office equipments, industrial, communications, and measurement equipments, personal or household devices, etc.).

CAUTION:

Customers considering the use of our products in special applications where failure or abnormal operation may directly affect human lives or cause physical injury or property damage, or where extremely high levels of reliability are demanded (such as aerospace systems, atomic energy controls, sea floor repeaters, vehicle operating controls, medical devices for life support, etc.) are requested to consult with FUJITSU sales representatives before such use. The company will not be responsible for damages arising from such use without prior approval.

Any semiconductor devices have inherently a certain rate of failure. You must protect against injury, damage or loss from such failures by incorporating safety design measures into your facility and equipment such as redundancy, fire protection, and prevention of over-current levels and other abnormal operating conditions.

If any products described in this document represent goods or technologies subject to certain restrictions on export under the Foreign Exchange and Foreign Trade Control Law of Japan, the prior authorization by Japanese government should be required for export of those products from Japan.