

SCRs

DESCRIPTION

Thanks to highly sensitive triggering levels, the UTC US104S is suitable for all applications where the available gate current is limited, such as motor control for hand tools, kitchen aids, overvoltage crowbar protection for low power supplies, ... Available in through-hole or surface-mount packages, they provide an optimized performance in a limited space area.

SYMBOL

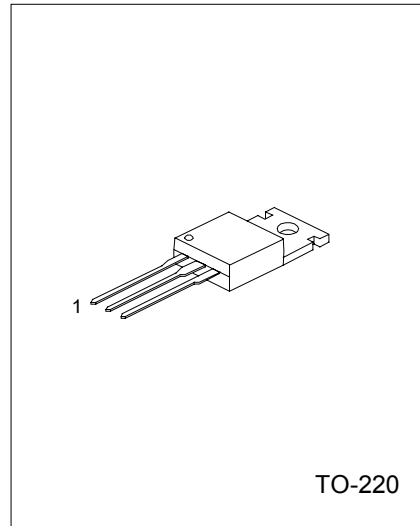
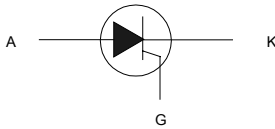

1: CATHODE 2: ANODE 3: GATE

ABSOLUTE RATINGS

PARAMETER	SYMBOL	RATING	UNIT
Repetitive peak off-state voltages and Repetitive peak reverse voltage US104S/N-4 US104S/N-6 US104S/N-8	V_{DRM}, V_{RRM}	400 600 800	V
RMS on-state current (180° conduction angle) (Tc = 115°C)	$I_{T(RMS)}$	4	A
Average on-state current (180° conduction angle) (Tc = 115°C)	$I_{T(AV)}$	2.5	A
Non repetitive surge peak on-state current (Tj = 25°C) tp=8.3ms tp=10ms	I_{TSM}	33 30	A
I ² t Value for fusing (tp = 10 ms, Tj = 25°C)	I ² t	4.5	A ² S
Critical rate of rise of on-state current (IG = 2 x IGT, tr ≤ 100 ns, F = 60 Hz, Tj = 125°C)	dI/dt	50	A/μs
Peak gate current (tp=20μs, Tj = 125°C)	IGM	1.2	A
Average gate power dissipation (Tj = 125°C)	PG(AV)	0.2	W
Storage junction temperature range	Tstg	-40 ~ +150	°C
Operating junction temperature range	Tj	-40 ~ +125	°C

UTC US104S(SENSITIVE) ELECTRICAL CHARACTERISTICS

(Tj=25°C unless otherwise specified)

PARAMETER	SYMBOL	TEST CONDITIONS	MIN	MAX.	UNIT
Gate trigger Current	IGT	VD = 12 V, RL = 33Ω		200	μA
Gate trigger Voltage	VGT	VD = 12 V, RL = 33Ω		0.8	V
Gate non-trigger voltage	VGD	VD = VDRM, RL = 3.3 kΩ, RGK = 220Ω Tj = 125°C	0.1		V
Reverse gate voltage	VRG	IRG = 10 μA	8		V
Holding Current	IH	IT = 50 mA, RGK = 1 kΩ		5	mA

UTC US104S/N

SCR

PARAMETER	SYMBOL	TEST CONDITIONS	MIN	MAX.	UNIT
Latching Current	I _L	I _G = 1 mA, R _{GK} = 1 kΩ		6	mA
Circuit Rate Of Change Of off-state Voltage	dV/dt	V _D = 67 % V _{DRM} , R _{GK} = 220 Ω T _j = 125°C	5		V/μs
On-state voltage	V _{TM}	I _{TM} = 8 A, t _p = 380 μs T _j = 25°C		1.6	V
Threshold Voltage	V _{t0}	T _j = 125°C		0.85	V
Dynamic Resistance	R _d	T _j = 125°C		90	mΩ
Off-state Leakage Current	I _{DRM}	V _{DRM} = V _{RRM} , R _{GK} = 220 Ω T _j = 25°C		5	μA
	I _{RRM}	V _{DRM} = V _{RRM} , R _{GK} = 220 Ω T _j = 125°C		1	mA

UTC US104N(STANDARD) ELECTRICAL CHARACTERISTICS

(T_j=25°C unless otherwise specified)

PARAMETER	SYMBOL	TEST CONDITIONS	MIN	MAX.	UNIT
Gate trigger Current	I _{GT}	V _D = 12 V, R _L = 33Ω	2	15	mA
Gate trigger Voltage	V _{GT}	V _D = 12 V, R _L = 33Ω		1.3	V
Gate non-trigger voltage	V _{GD}	V _D = V _{DRM} , R _L = 3.3 kΩ, T _j = 125°C	0.2		V
Holding Current	I _H	I _T = 100 mA, Gate open		30	mA
Latching Current	I _L	I _G = 1.2 I _{GT}		60	mA
Circuit Rate Of Change Of off-state Voltage	dV/dt	V _D = 67 % V _{DRM} , Gate open, T _j = 125°C	100		V/μs
On-state voltage	V _{TM}	I _{TM} = 8A, t _p = 380 μs, T _j = 25°C		1.6	V
Threshold Voltage	V _{t0}	T _j = 125°C		0.85	V
Dynamic Resistance	R _d	T _j = 125°C		62	mΩ
Off-state Leakage Current	I _{DRM}	V _{DRM} = V _{RRM} T _j = 25°C		5	μA
	I _{RRM}	T _j = 125°C		2	mA

THERMAL RESISTANCES

PARAMETER	SYMBOL	VALUE	UNIT
Junction to case (DC)	R _{th(j-c)}	3.0	K/W
Junction to ambient (DC)	R _{th(j-a)}	60	K/W

Fig.1:Maximum average power dissipation vs average on-state current

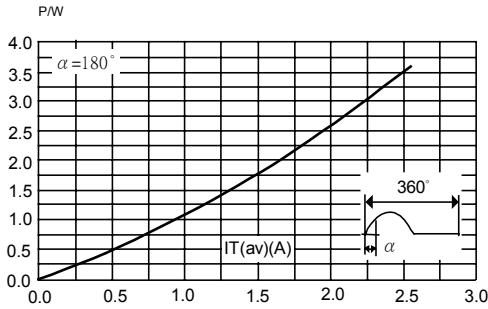

Figure.3:Relative variation of gate trigger current and holding current vs junction temperature.

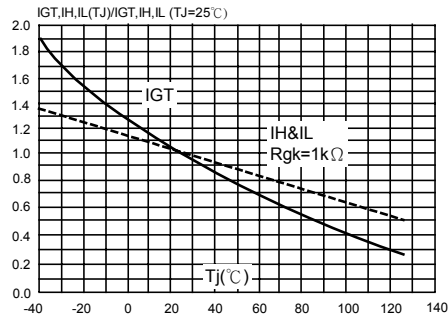

Fig.5: Relative variation of dV/dt immunity vs gate-cathode resistance (typical values).

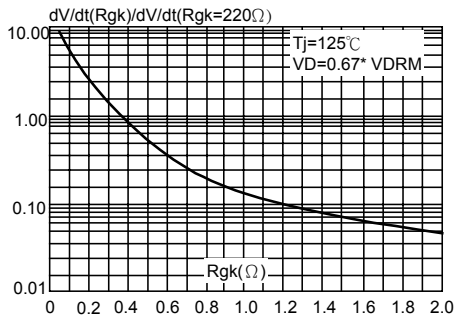

Figure.2:Average and D.C. on-state current vs case temperature

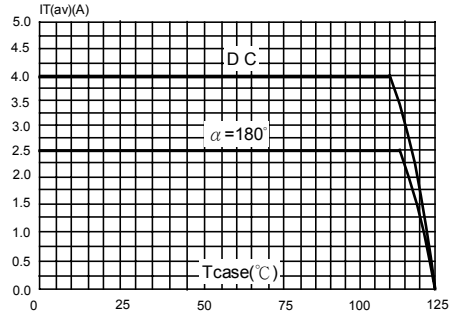

Figure.4:Relative variation of holding current vs gate-cathode resistance (typical values).

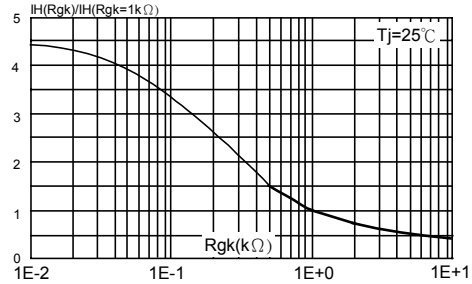

Fig.6: Relative variation of dV/dt immunity vs gate-cathode resistance (typical values).

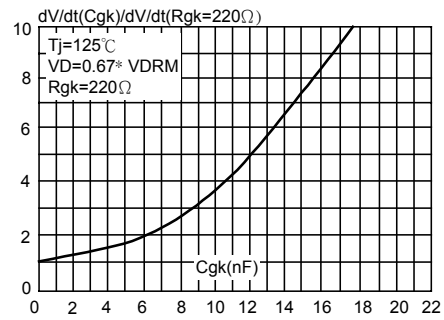

Figure.7: Surge peak on-state current vs number of cycles.

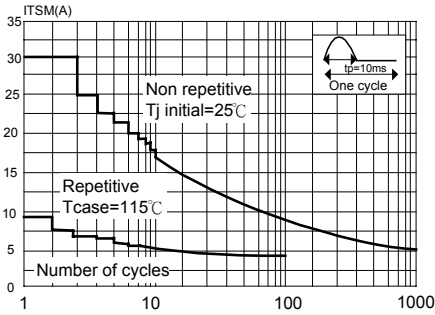

Fig.8:Non-repetitive surge peak on-state current for a sinusoidal pulse with width $t_p < 10\text{ms}$, and corresponding values of $f t$.

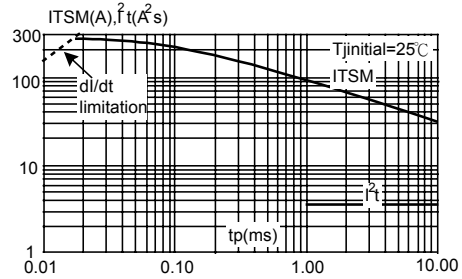
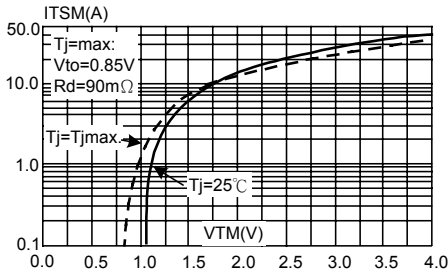

Fig.9: On-state characteristics(maximum values).



UTC assumes no responsibility for equipment failures that result from using products at values that exceed, even momentarily, rated values (such as maximum ratings, operating condition ranges, or other parameters) listed in products specifications of any and all UTC products described or contained herein. UTC products are not designed for use in life support appliances, devices or systems where malfunction of these products can be reasonably expected to result in personal injury. Reproduction in whole or in part is prohibited without the prior written consent of the copyright owner. The information presented in this document does not form part of any quotation or contract, is believed to be accurate and reliable and may be changed without notice.