

### Insulated Ultrafast Rectifier Module

#### Features

- Two Fully Independent Diodes
- Ceramic Fully Insulated Package ( $V_{ISOL} = 2500V$  AC)
- Ultrafast Reverse Recovery
- Ultrasoft Reverse Recovery Current Shape
- Low Forward Voltage
- Optimized for Power Conversion: Welding and Industrial SMPS Applications
- Industry Standard Outline
- Plug-in Compatible with other SOT-227 Packages
- Easy to Assemble
- Direct Mounting to Heatsink

$t_{rr} = 35ns$ $I_{F(AV)} = 120A$ @ $T_C = 65^\circ C$ $V_R = 400V$
---

#### Description

The UFB120FA40 insulated modules integrate two state-of-the-art International Rectifier's Ultrafast recovery rectifiers in the compact, industry standard SOT-227 package. The planar structure of the diodes, and the platinum doping life-time control, provide a Ultrasoft recovery current shape, together with the best overall performance, ruggedness and reliability characteristics.

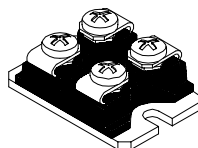
These devices are thus intended for high frequency applications in which the switching energy is designed not to be predominant portion of the total energy, such as in the output rectification stage of Welding machines, SMPS, DC-DC converters. Their extremely optimized stored charge and low recovery current reduce both over dissipation in the switching elements (and snubbers) and EMI/ RFI.

#### Absolute Maximum Ratings

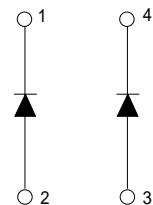
Parameters	Max	Units
$V_R$ Cathode-to-Anode Voltage	400	V
$I_F$ Continuous Forward Current, $T_C = 65^\circ C$ Per Diode	60	A
$I_{FSM}$ Single Pulse Forward Current, $T_C = 25^\circ C$ Per Diode	800	
$P_D$ Max. Power Dissipation, $T_C @ 90^\circ C$ Per Module	96	W
$V_{ISOL}$ RMS Isolation Voltage, Any Terminal to Case, $t = 1$ min	2500	V
$T_J, T_{STG}$ Operating Junction and Storage Temperatures	- 55 to 150	$^\circ C$

#### Case Styles

UFB120FA40



SOT-227



Electrical Characteristics @  $T_J = 25^\circ\text{C}$  (unless otherwise specified) per diode

Parameters	Min	Typ	Max	Units	Test Conditions
$V_{BR}$ Cathode Anode Breakdown Voltage	400	-	-	V	$I_R = 100\mu\text{A}$
$V_{FM}$ Forward Voltage	-	1.16	1.37	V	$I_F = 60\text{A}$
	-	0.96	1.13	V	$I_F = 60\text{A}, T_J = 150^\circ\text{C}$
$I_{RM}$ Reverse Leakage Current	-	-	0.1	mA	$V_R = V_R \text{ Rated}$
	-	-	1	mA	$T_J = 150^\circ\text{C}, V_R = V_R \text{ Rated}$
$C_T$ Junction Capacitance	-	67	-	pF	$V_R = 400\text{V}$

Dynamic Recovery Characteristics @  $T_J = 25^\circ\text{C}$  (unless otherwise specified) per diode

Parameters	Min	Typ	Max	Units	Test Conditions
$t_{rr}$ Reverse Recovery Time	-	30	35	ns	$I_F = 1.0\text{A}, di_F/dt = 200\text{A}/\mu\text{s}, V_R = 30\text{V}$
	-	65	-		$T_J = 25^\circ\text{C}$
	-	128	-		$T_J = 125^\circ\text{C}$
$I_{RRM}$ Peak Recovery Current	-	7.4	-	A	$T_J = 25^\circ\text{C}$
	-	17.8	-		$T_J = 125^\circ\text{C}$
$Q_{rr}$ Reverse Recovery Charge	-	240	-	nC	$T_J = 25^\circ\text{C}$
	-	1139	-		$T_J = 125^\circ\text{C}$

## Thermal - Mechanical Characteristics

Parameters	Min	Typ	Max	Units		
$R_{thJC}$ Junction to Case	Single Diode Conducting		-	0.99	1.24	$^\circ\text{C}/\text{W}$
	Both Diodes Conducting		-	0.49	0.62	$^\circ\text{C}/\text{W}$
$R_{thCS}$ Case to Heat Sink, Flat, Greased Surface	-	0.05	-			
$W_t$ Weight	-	30	-		g	
$T$ Mounting Torque	-	1.3	-		(N*m)	

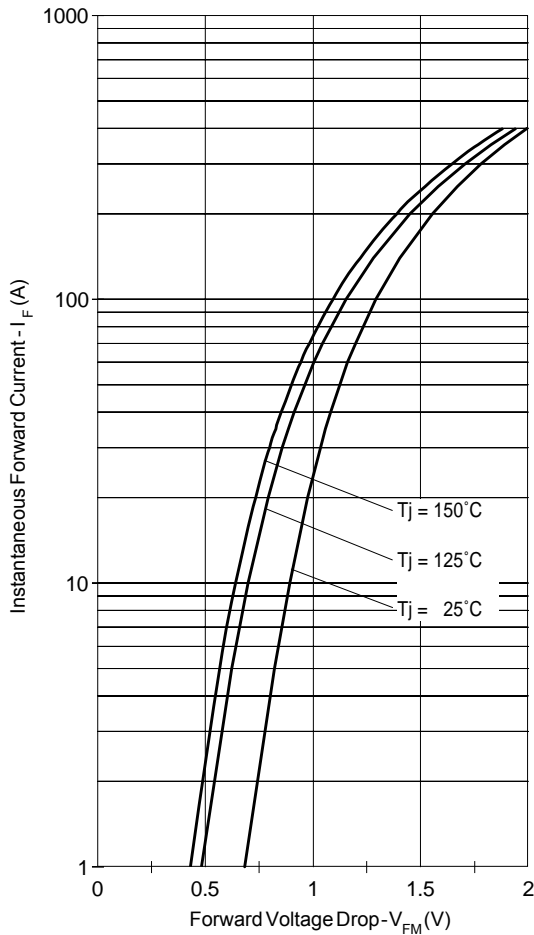


Fig. 1 - Typical Forward Voltage Drop Characteristics (per diode)

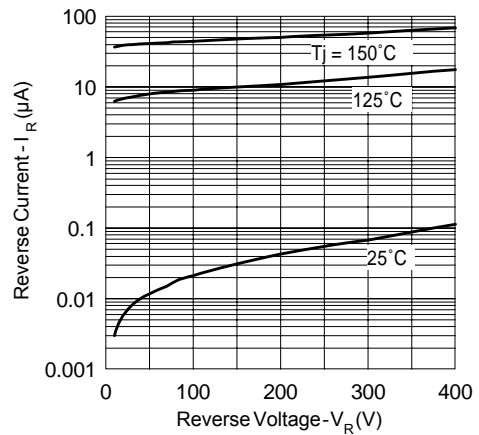


Fig. 2 - Typical Values Of Reverse Current Vs. Reverse Voltage

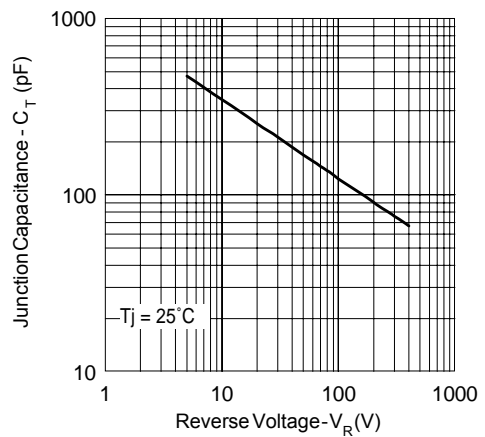


Fig. 3 - Typical Junction Capacitance Vs. Reverse Voltage

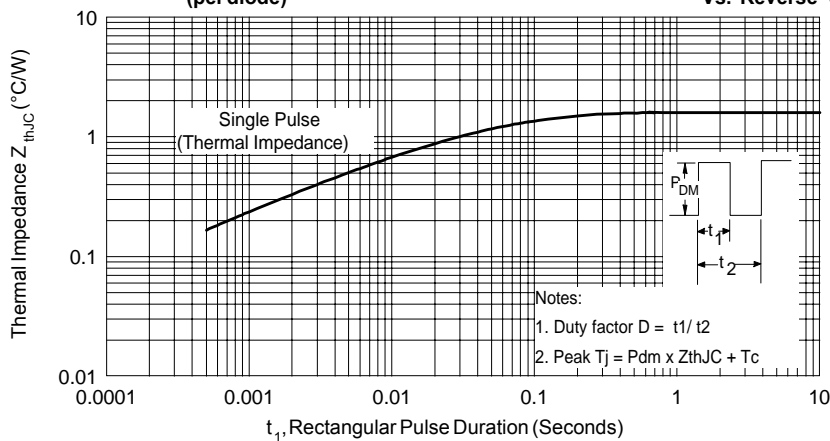
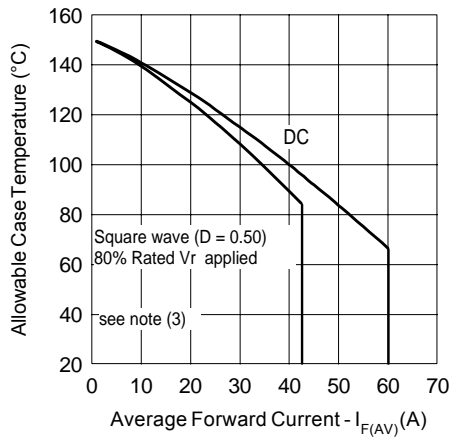
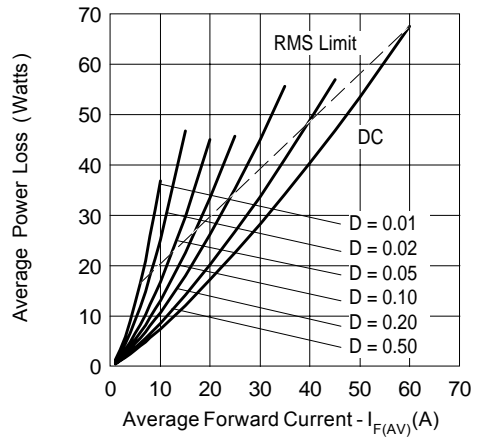


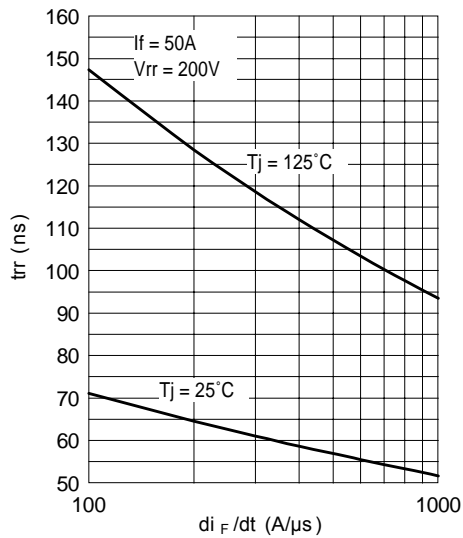
Fig. 4 - Max. Thermal Impedance  $Z_{thJC}$  (per diode)



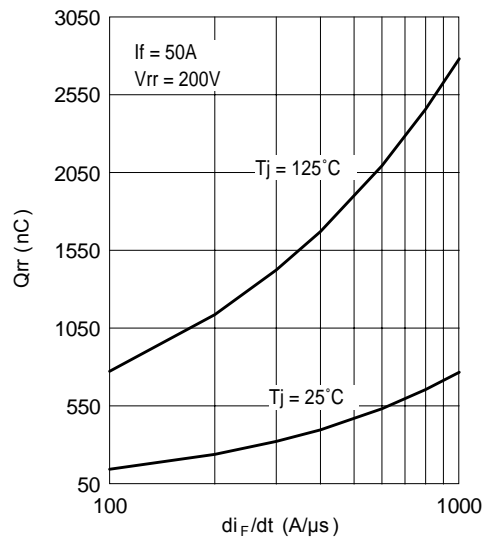
**Fig. 5 - Max. Allowable Case Temperature Vs. Average Forward Current (per diode)**



**Fig. 6 - Forward Power Loss (per diode)**

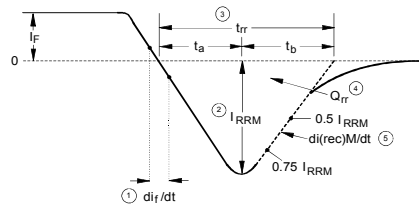
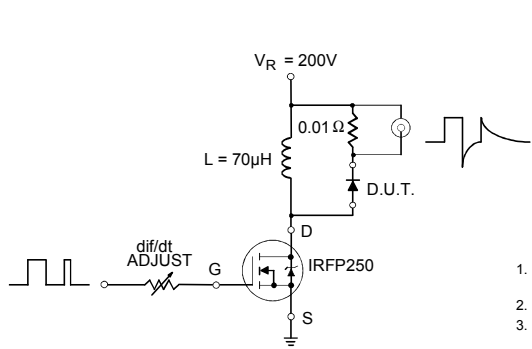


**Fig. 7 - Typical Reverse Recovery time vs. di\_F/dt**



**Fig. 8 - Typical Stored Charge vs. di\_F/dt**

(3) Formula used:  $T_c = T_j - (P_d + P_{d_{REV}}) \times R_{thJC}$ ;  
 $P_d = \text{Forward Power Loss} = I_{F(AV)} \times V_{FM} @ (I_{F(AV)} / D)$  (see Fig. 6);  
 $P_{d_{REV}} = \text{Inverse Power Loss} = V_{R1} \times I_R (1 - D)$ ;  $I_R @ V_{R1} = 80\% \text{ rated } V_R$



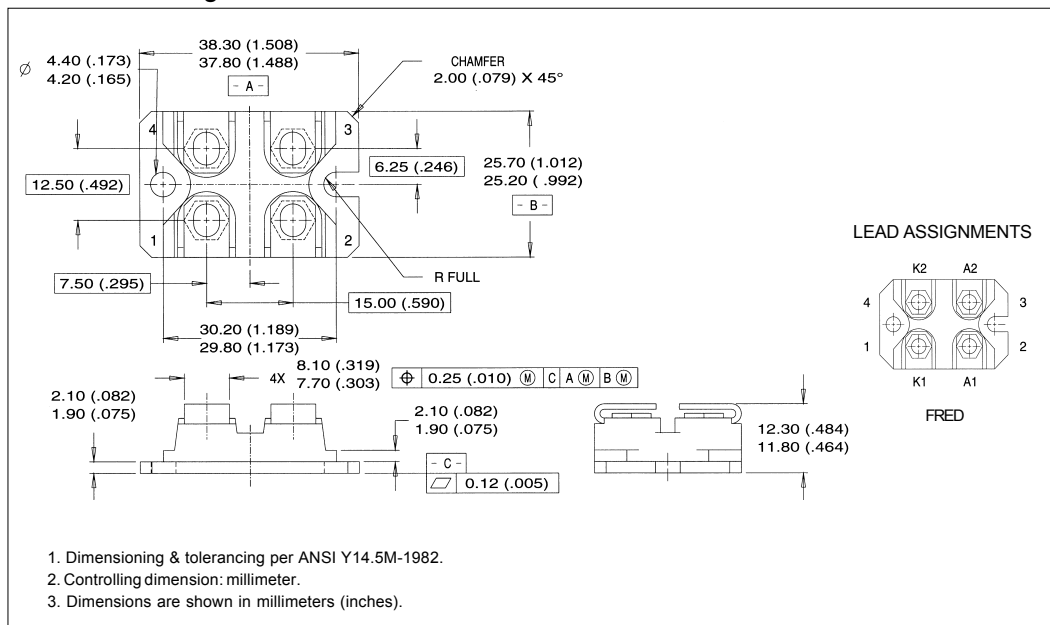
1.  $di_f/dt$  - Rate of change of current through zero crossing
2.  $I_{RRM}$  - Peak reverse recovery current
3.  $t_{rr}$  - Reverse recovery time measured from zero crossing point of negative going  $I_F$  to point where a line passing through  $0.75 I_{RRM}$  and  $0.5 I_{RRM}$  extrapolated to zero current
4.  $Q_{rr}$  - Area under curve defined by  $t_{rr}$  and  $I_{RRM}$   

$$Q_{rr} = \frac{t_{rr} \times I_{RRM}}{2}$$
5.  $di_{(rec)M}/dt$  - Peak rate of change of current during  $t_b$  portion of  $t_{rr}$

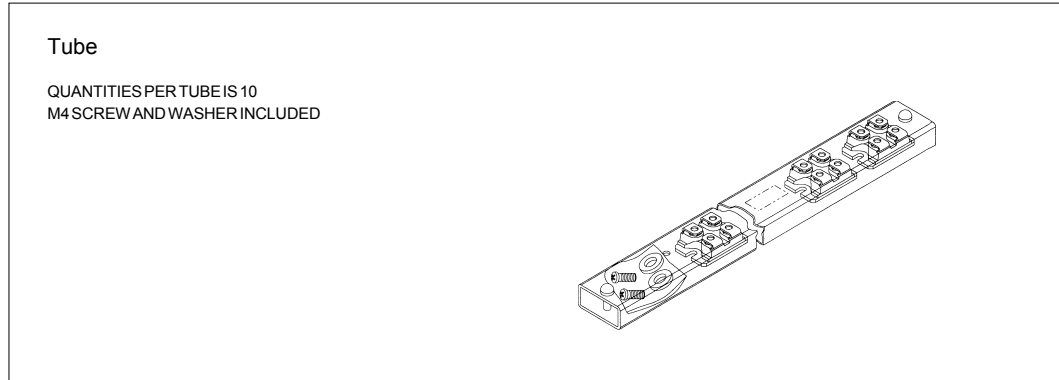
Fig. 1 - Reverse Recovery Parameter Test Circuit

Fig. 2 - Reverse Recovery Waveform and Definitions

### SOT-227 Package Details



**SOT-227 Package Details**



**Ordering Information Table**

**Device Code**

<b>UF</b>	<b>B</b>	<b>120</b>	<b>F</b>	<b>A</b>	<b>40</b>
①	②	③	④	⑤	⑥

- 1** - ULTRAFast RECTIFIER
- 2** - Ultrafst Pt diffused
- 3** - Current Rating (120 = 120A)
- 4** - Circuit Configuration (2 separate Diodes, parallel pin-out)
- 5** - Package Indicator (SOT-227 Standard Isolated Base)
- 6** - Voltage Rating (40 = 400V)

Data and specifications subject to change without notice.  
This product has been designed and qualified for Industrial Level.  
Qualification Standards can be found on IR's Web site.