

High voltage power Schottky rectifier

Main product characteristics

$I_{F(AV)}$	2 x 7.5 A
V_{RRM}	100 V
T_j (max)	175° C
V_F (max)	0.67 V

Features and Benefits

- Negligible switching losses
- Low leakage current
- Good trade off between leakage current and forward voltage drop
- Low thermal resistance
- Avalanche capability specified

Description

Dual center tab Schottky rectifier suited for switched mode power supply and high frequency DC to DC converters.

Packaged in DPAK and IPAK, this device is intended for use in high frequency inverters.

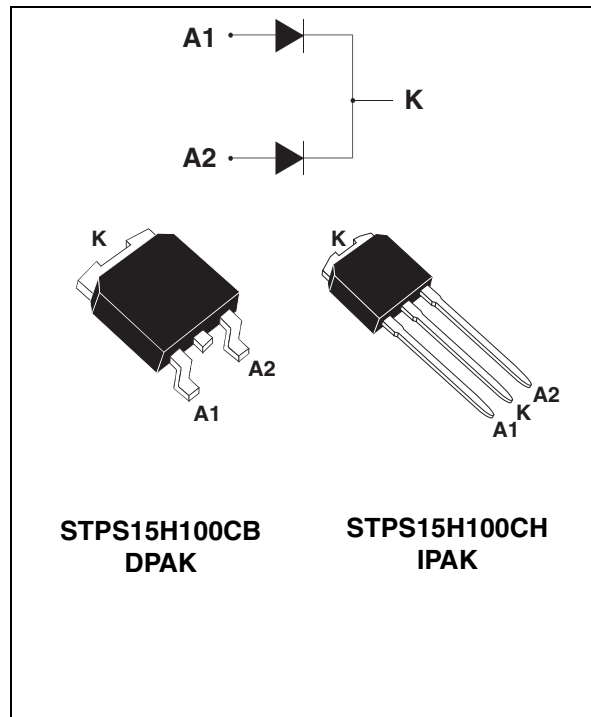

Table 1. Absolute Ratings (limiting values, per diode)

Symbol	Parameter	Value	Unit	
V_{RRM}	Repetitive peak reverse voltage	100	V	
$I_{F(RMS)}$	RMS forward current	10	A	
$I_{F(AV)}$	Average forward current	$T_c = 135^\circ\text{C}$ Per diode	7.5	A
		$\delta = 0.5$ Per device	15	
I_{FSM}	Surge non repetitive forward current	$t_p = 10\text{ ms}$ sinusoidal	75	A
I_{RRM}	Peak repetitive reverse current	$t_p = 2\ \mu\text{s}$ square $F = 1\text{ kHz}$	1	A
P_{ARM}	Repetitive peak avalanche power	$t_p = 1\ \mu\text{s}$ $T_j = 25^\circ\text{C}$	6600	W
T_{stg}	Storage temperature range	-65 to + 175	°C	
T_j	Maximum operating junction temperature ⁽¹⁾	175	°C	
dV/dt	Critical rate of rise of reverse voltage	10000	V/ μs	

1. $\frac{dP_{tot}}{dT_j} < \frac{1}{R_{th(j-a)}}$ condition to avoid thermal runaway for a diode on its own heatsink

1 Characteristics

Table 2. Thermal resistance

Symbol	Parameter		Value	Unit
R _{th(j-c)}	Junction to case	Per diode	4	°C/W
		Total	2.4	
R _{th(c)}	Coupling		0.7	

When the diodes 1 and 2 are used simultaneously :

$$\Delta T_j(\text{diode 1}) = P(\text{diode1}) \times R_{th(j-c)}(\text{Per diode}) + P(\text{diode 2}) \times R_{th(c)}$$

Table 3. Static electrical characteristics (per diode)

Symbol	Parameter	Test Conditions		Min.	Typ.	Max.	Unit
I _R ⁽¹⁾	Reverse leakage current	T _j = 25° C	V _R = V _{RRM}			3	µA
		T _j = 125° C			1.3	4	mA
V _F (1)	Forward voltage drop	T _j = 25° C	I _F = 7.5 A			0.8	V
		T _j = 125° C	I _F = 7.5 A		0.62	0.67	
		T _j = 25° C	I _F = 12 A			0.85	
		T _j = 125° C	I _F = 12 A		0.68	0.73	
		T _j = 25° C	I _F = 15 A			0.89	
		T _j = 125° C	I _F = 15 A		0.71	0.76	

1. Pulse test: tp = 380 µs, δ < 2%

To evaluate the conduction losses use the following equation:

$$P = 0.58 \times I_{F(AV)} + 0.012 I_{F(RMS)}^2$$

Figure 1. Conduction losses versus average current

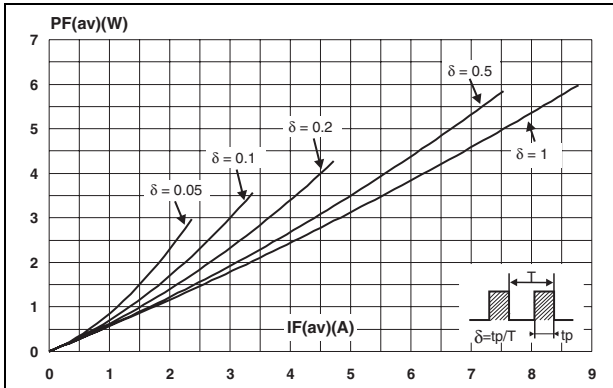

Figure 2. Average forward current $(\delta = 0.5)$ versus ambient temperature

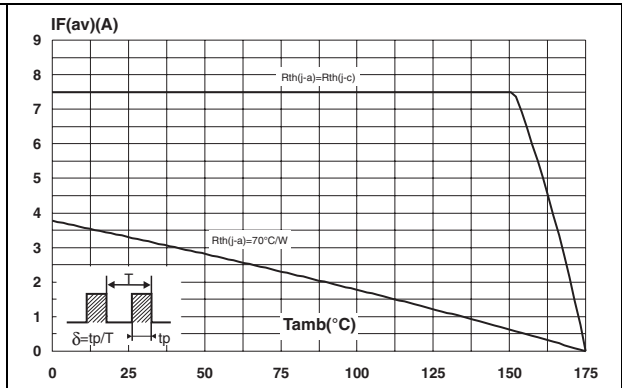

Figure 3. Normalized avalanche power derating versus pulse duration

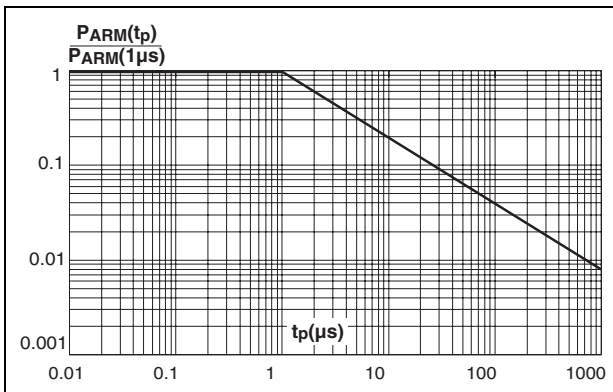

Figure 4. Normalized avalanche power derating versus junction temperature

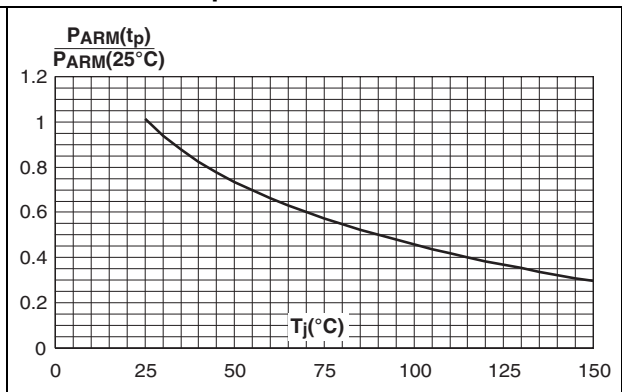

Figure 5. Non repetitive surge peak forward current versus overload duration (maximum values)

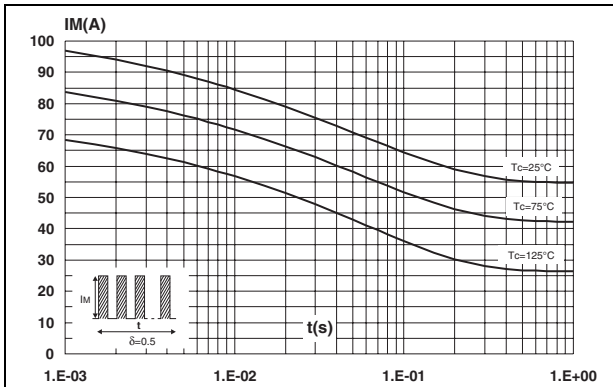

Figure 6. Relative variation of thermal impedance junction to case versus pulse duration

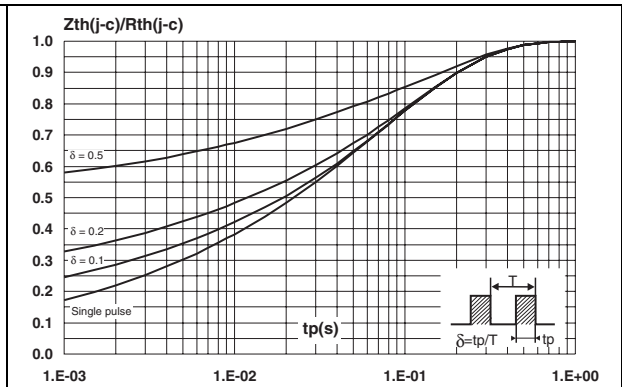

Figure 7. Reverse leakage current versus reverse voltage applied (typical values)

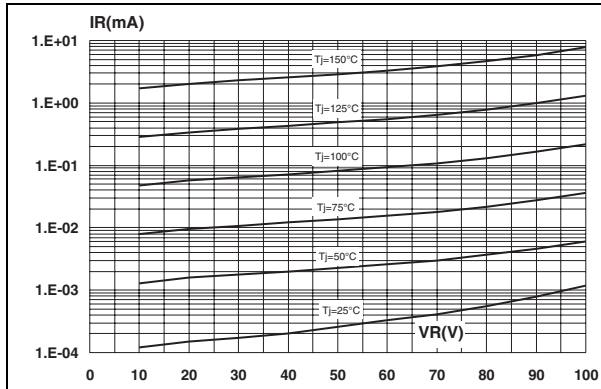

Figure 8. Junction capacitance versus reverse voltage applied (typical values)

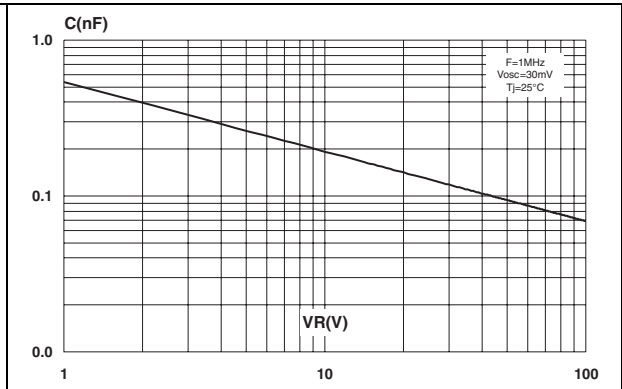

Figure 9. Forward voltage drop versus forward current

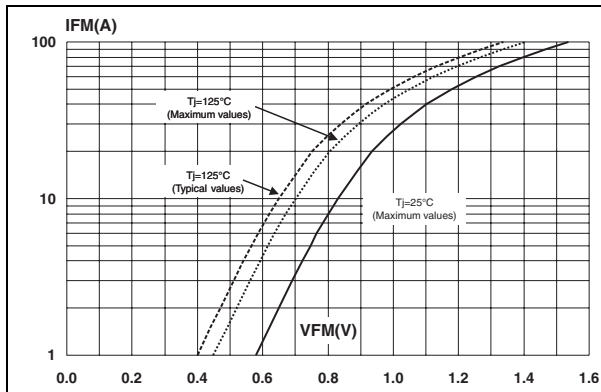
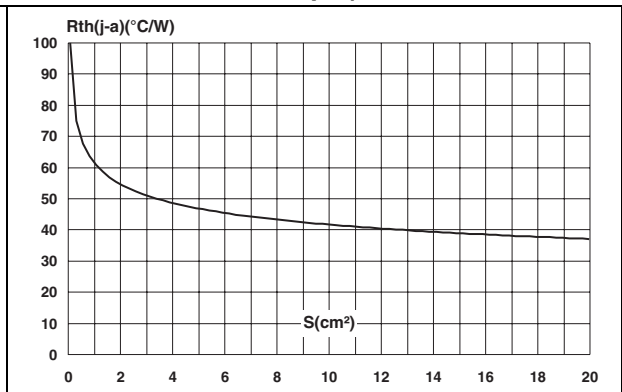

Figure 10. Thermal resistance junction to ambient versus copper surface under tab (epoxy printed board FR4, Cu: 35µm)



2 Package Information

Epoxy meets UL94,V0

Table 4. DPAK Package mechanical data

Ref	Dimensions			
	Millimeters		Inches	
	Min.	Max.	Min.	Max.
A	2.20	2.40	0.086	0.094
A1	0.90	1.10	0.035	0.043
A2	0.03	0.23	0.001	0.009
B	0.64	0.90	0.025	0.035
B2	5.20	5.40	0.204	0.212
C	0.45	0.60	0.017	0.023
C2	0.48	0.60	0.018	0.023
D	6.00	6.20	0.236	0.244
E	6.40	6.60	0.251	0.259
G	4.40	4.60	0.173	0.181
H	9.35	10.10	0.368	0.397
L2	0.80 typ.		0.031 typ.	
L4	0.60	1.00	0.023	0.039
V2	0°	8°	0°	8°

Figure 11. DPAK Footprint (dimensions in mm)

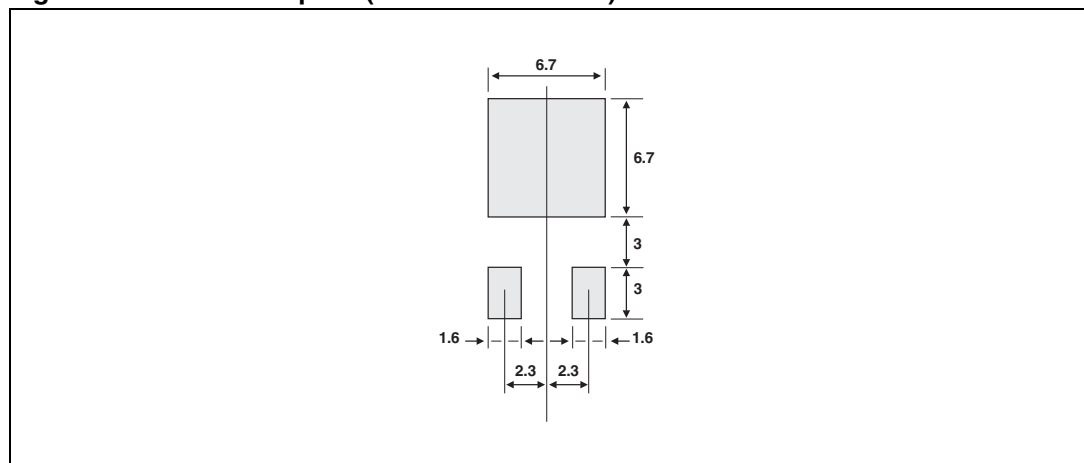
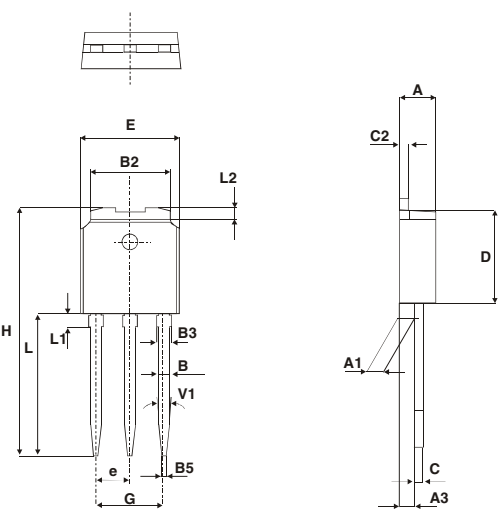

Table 5. IPAK Package mechanical data



Ref.	Dimensions					
	Millimeters			Inches		
	Min.	Typ.	Max.	Min.	Typ.	Max.
A	2.20		2.40	0.086		0.094
A1	0.90		1.10	0.035		0.043
A3	0.70		1.30	0.027		0.051
B	0.64		0.90	0.025		0.035
B2	5.20		5.40	0.204		0.212
B3			0.95			0.037
B5		0.30			0.035	
C	0.45		0.60	0.017		0.023
C2	0.48		0.60	0.019		0.023
D	6		6.20	0.236		0.244
E	6.40		6.60	0.252		0.260
e		2.28			0.090	
G	4.40		4.60	0.173		0.181
H		16.10			0.634	
L	9		9.40	0.354		0.370
L1	0.8		1.20	0.031		0.047
L2		0.80	1		0.031	0.039
V1		10°			10°	

3 Ordering Information

Ordering type	Marking	Package	Weight	Base qty	Delivery mode
STPS15H100CB	S15H100	DPAK	0.30 g	75	Tube
STPS15H100CB-TR	S15H100	DPAK	0.30 g	2500	Tape and reel
STPS15H100CH	S15H100CH	IPAK	0.35 g	75	Tube

4 Revision History

Date	Revision	Changes
Mar-2004	3	Last issue
08-Jun-2006	4	Reformatted to current standard. Added IPAK.

Please Read Carefully:

Information in this document is provided solely in connection with ST products. STMicroelectronics NV and its subsidiaries ("ST") reserve the right to make changes, corrections, modifications or improvements, to this document, and the products and services described herein at any time, without notice.

All ST products are sold pursuant to ST's terms and conditions of sale.

Purchasers are solely responsible for the choice, selection and use of the ST products and services described herein, and ST assumes no liability whatsoever relating to the choice, selection or use of the ST products and services described herein.

No license, express or implied, by estoppel or otherwise, to any intellectual property rights is granted under this document. If any part of this document refers to any third party products or services it shall not be deemed a license grant by ST for the use of such third party products or services, or any intellectual property contained therein or considered as a warranty covering the use in any manner whatsoever of such third party products or services or any intellectual property contained therein.

UNLESS OTHERWISE SET FORTH IN ST'S TERMS AND CONDITIONS OF SALE ST DISCLAIMS ANY EXPRESS OR IMPLIED WARRANTY WITH RESPECT TO THE USE AND/OR SALE OF ST PRODUCTS INCLUDING WITHOUT LIMITATION IMPLIED WARRANTIES OF MERCHANTABILITY, FITNESS FOR A PARTICULAR PURPOSE (AND THEIR EQUIVALENTS UNDER THE LAWS OF ANY JURISDICTION), OR INFRINGEMENT OF ANY PATENT, COPYRIGHT OR OTHER INTELLECTUAL PROPERTY RIGHT.

UNLESS EXPRESSLY APPROVED IN WRITING BY AN AUTHORIZED REPRESENTATIVE OF ST, ST PRODUCTS ARE NOT DESIGNED, AUTHORIZED OR WARRANTED FOR USE IN MILITARY, AIR CRAFT, SPACE, LIFE SAVING, OR LIFE SUSTAINING APPLICATIONS, NOR IN PRODUCTS OR SYSTEMS, WHERE FAILURE OR MALFUNCTION MAY RESULT IN PERSONAL INJURY, DEATH, OR SEVERE PROPERTY OR ENVIRONMENTAL DAMAGE.

Resale of ST products with provisions different from the statements and/or technical features set forth in this document shall immediately void any warranty granted by ST for the ST product or service described herein and shall not create or extend in any manner whatsoever, any liability of ST.

ST and the ST logo are trademarks or registered trademarks of ST in various countries.

Information in this document supersedes and replaces all information previously supplied.

The ST logo is a registered trademark of STMicroelectronics. All other names are the property of their respective owners.

© 2006 STMicroelectronics - All rights reserved

STMicroelectronics group of companies

Australia - Belgium - Brazil - Canada - China - Czech Republic - Finland - France - Germany - Hong Kong - India - Israel - Italy - Japan - Malaysia - Malta - Morocco - Singapore - Spain - Sweden - Switzerland - United Kingdom - United States of America

www.st.com