

Silicon Protection Circuits

Surface Mount Surgeor™ Transient Voltage Suppressors

Surgeor Thyristors For Telecom Protection



Designed to suppress lightning and other transients, Surgeor suppressors are primarily intended for operation on the telephone line “tip and ring” environment in order to protect telecommunications CPE and COE products in conjunction with the Littelfuse 461 series Telecom Nano²⁰ fuse. These devices provide secondary protection for telecommunication equipment such as telephone, MODEM, line card and other devices subject to damage from transient over voltage events. Surgeors can be an integral part of a Telephone Line Protector Unit, meeting AC Power Cross criteria when used in association with properly selected resistor/ PTC/ fuse combinations such as the Littelfuse 461 series fuse. Littelfuse Surface Mount Surgeors are manufactured using a silicon thyristor technology, offering bidirectional voltage clamping for transients of either polarity from a single chip.

The Surgeor devices described in this data sheet are manufactured with the DO-214AA low profile case style and are second source equivalent parts to industry “SIDAC” types. Surface Mount Surgeor Suppressors are supplied in embossed carrier tape on 330mm (13in) reels.

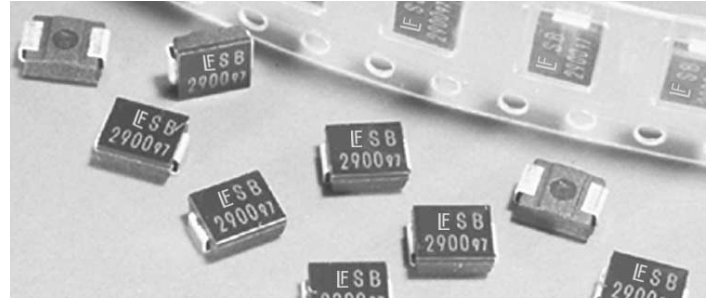

Ordering Information

PART NUMBER	V _{BD} (MAX) AT _{I_{BD}} =800MA (V)	I _{pp} (MAX) 10 x 1000µs Pulse (A)	I _{pp} (MAX) 2 x 10µs Pulse (A)
B TYPES			
SGT0640SBT	77	50	320
SGT0720SBT	88	50	320
SGT2300SBT	260	50	200
SGT2900SBT	330	50	200
SGT3100SBT	350	50	200
C TYPES			
SGT0640SCT	77	100	600
SGT0720SCT	88	100	600
SGT1300SCT	160	100	600
SGT1500SCT	180	100	600
SGT2300SCT	260	100	500
SGT2900SCT	330	100	500
SGT3100SCT	350	100	500
SGT3500SCT	400	100	500

NOTE: T Suffix indicates Tape and Reel.

Features

- Rated for Telecom Industry Transient Surge Levels:
 - Telcordia (Bellcore) GR-1089
 - ITU CCITT K.20/.21
 - FCC PART 68
 - UL 60950
- Low Profile Package, Compatible with PCMCIA Cards, UL-94V-0 Listed
- Offered in the Most Common V_{DRM} Voltage Types
- Low On-State Voltage
- Cross to Common Industry Types
- High Minimum Holding Current

AGENCY APPROVALS: Recognized under the components program of Underwriters Laboratories.

AGENCY FILE NUMBERS: UL E135010.

Applications

- Secondary Protection for:
 - DSL modem
 - Set Top Box
 - Telephone
 - FAX
 - Modem
 - Line Cards
 - SLIC
 - TLPU Modules
- Alarm Systems
- CATV Lines
- Cable Modems

Symbol



Surgeor Thyristors For Telecom Protection

Absolute Maximum Ratings

Continuous Reverse Voltage, V_{DRM}58V to 300V	
Transient Peak Surge Current, I_{pp}	B Types	C Types
8 x 20 μ s	200A	400A
10 x 160 μ s	150A	200A
10 x 560 μ s	100A	150A
10 x 1000 μ s	50A	100A
Critical Rate of Rise of Voltage, dv/dt	2000V/ μ s	

Thermal Information

Thermal Resistance (Typical, Note 1)	θ_{JA} (°C/W)
J-Bend Package	
C Types.....	85
B Type.....	90
Maximum Storage Temperature Range.....	- 65°C to 150°C
Maximum Junction Temperature (Plastic Package).....	150°C
Maximum Lead Temperature (Soldering 5s).....	300°C

Operating Conditions

Temperature Range, (T_A)..... -40°C to 85°C

CAUTION: Stresses above those listed in "Absolute Maximum Ratings" may cause permanent damage to the device. This is a stress only rating and operation of the device at these or any other conditions above those indicated in the operational sections of this specification is not implied.

NOTE:

1. θ_{JA} is measured with the component mounted on an evaluation PC board in free air.

Electrical Specifications $T_C = 25^\circ\text{C}$, Unless Otherwise Specified

MODEL NUMBER	V_{DRM} (MAX) V	I_{DRM} (MAX) AT V_{DRM} μ A	V_T (MAX) AT 2 A V	V_{BO} (MAX) AT $I_{BO} = 800\text{mA}$ (NOTE 2) V	I_H (MIN) mA	I_{pp} (MAX) FOR 10 x 1000 μ s PULSE (NOTE 3) A	I_{TSM} (NOTE 4) A	C_O (Typ) AT 1MHz / 1 $V_{RMS}, 2V_{DC}$ pF
B TYPES								
SGT0640SBT	58	5	5	77	150	50	25	80
SGT0720SBT	63	5	5	88	150	50	25	80
SGT2300SBT	190	5	5	260	150	50	25	30
SGT2900SBT	250	5	5	330	150	50	25	30
SGT3100SBT	275	5	5	350	150	50	25	30
C TYPES								
SGT0640SCT	58	5	5	77	150	100	65	280
SGT0720SCT	63	5	5	88	150	100	65	280
SGT1300SCT	120	5	5	160	150	100	65	150
SGT1500SCT	140	5	5	190	150	100	65	150
SGT2300SCT	190	5	5	260	150	100	65	100
SGT2900SCT	250	5	5	330	150	100	65	70
SGT3100SCT	275	5	5	350	150	100	65	70
SGT3500SCT	300	5	5	400	150	100	65	55

NOTES:

- $dv/dt = 100V/\mu s$.
- Double exponential current waveform.
- One half cycle, 50 to 60Hz sine, non repetitive.

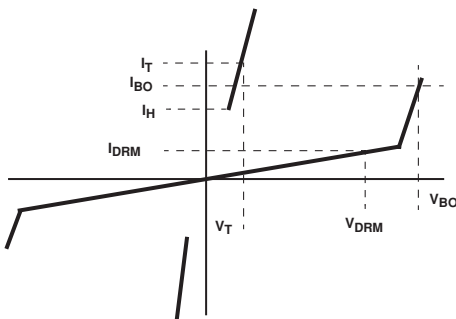
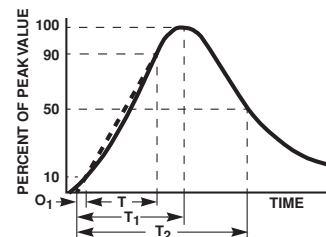

FIGURE 1. V-I CHARACTERISTICS



O_1 = Virtual Origin of Wave
 T = Time From 10% to 90% of Peak
 T_1 = Virtual Front Time = $1.25 \cdot t$
 T_2 = Virtual Time to Half Value (Impulse Duration)

Example: For an 8/20 μ s Current Waveform:
 $8\mu s = T_1$ = Virtual Front Time
 $20\mu s = T_2$ = Virtual Time to Half Value

FIGURE 2. PEAK PULSE CURRENT TEST WAVEFORM

Surgeor Thyristors For Telecom Protection

TABLE 1. ELECTRICAL CHARACTERISTICS

MODEL NUMBER	VARIATION OF V_{BO} vs TEMP $T_A = -40^{\circ}C$ TO $85^{\circ}C$ (%) (NOTE 5)	TYPICAL V_T AT PEAK $I_T, T_A = 25^{\circ}C$ VOLTS (V) (NOTE 6)	VARIATION OF C_O vs FREQUENCY (%) (NOTE 7)	MAXIMUM CRITICAL RATE OF RISE OF ON-STATE CURRENT (dI/dT)(A/ μs) (NOTE 8)	MAXIMUM I_{PP} FOR $2 \times 10 \mu s$ WAVEFORM (A) (NOTE 9)
SGT0640SBT	-6 to +6	4.2 at 50A	1	120	320
SGT0720SBT	-6 to +6	4.2 at 50A	1	120	320
SGT2300SBT	-5 to +4	3.2 at 50A	1	120	200
SGT2900SBT	-4 to +4	3.3 at 50A	1	120	200
SGT3100SBT	-4 to +4	3.3 at 50A	1	120	200
SGT0640SCT	-6 to +6	5.2 at 100A	1	250	600
SGT0720SCT	-6 to +6	5.2 at 100A	1	250	600
SGT1300SCT	-5 to +1	4.1 at 100A	1	250	600
SGT1500SCT	-5 to +1	4.1 at 100A	1	250	600
SGT2300SCT	-5 to +4	4.9 at 100A	1	250	500
SGT2900SCT	-4 to +4	7.2 at 100A	1	250	500
SGT3100SCT	-4 to +4	7.2 at 100A	1	250	500
SGT3500SCT	-3 to +4	7.7 at 100A	2	250	500

NOTES:

- Typical percentage shift from normalized 25°C value (positive coefficient).
- Typical maximum peak forward voltage drop at specified peak current.
- Typical percentage shift with test frequency ranging from 1kHz to 1MHz/ $1V_{RMS}$ (for two constant DC bias voltages of 0V and 50V).
- dI/dT for leading edge of sine wave where 1/2 rated I_{PP} is reached at initial 30° of the sine.
- Rated I_{PP} value for the $2 \times 10 \mu s$ waveform above which could cause device damage.

Typical Performance Curves

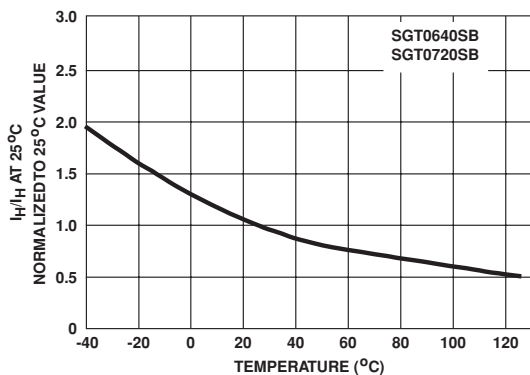

FIGURE 3. TYPICAL HOLDING CURRENT vs JUNCTION TEMPERATURE

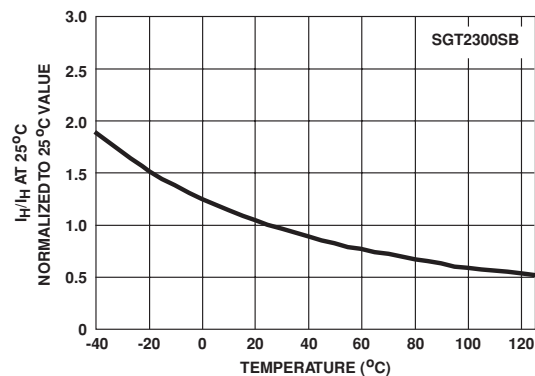

FIGURE 4. TYPICAL HOLDING CURRENT vs JUNCTION TEMPERATURE

Surgeor Thyristors For Telecom Protection

Typical Performance Curves (Continued)

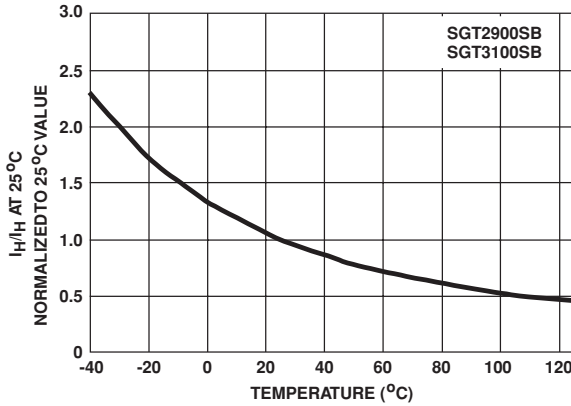

FIGURE 5. TYPICAL HOLDING CURRENT vs JUNCTION TEMPERATURE

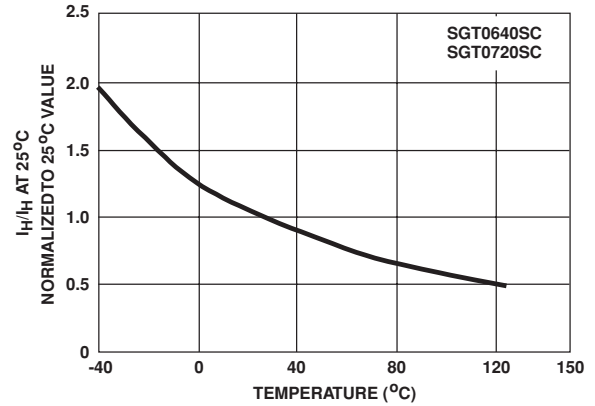

FIGURE 6. TYPICAL HOLDING CURRENT vs JUNCTION TEMPERATURE

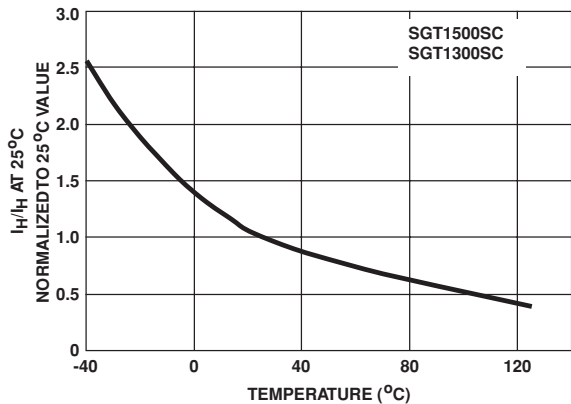

FIGURE 7. TYPICAL HOLDING CURRENT vs JUNCTION TEMPERATURE

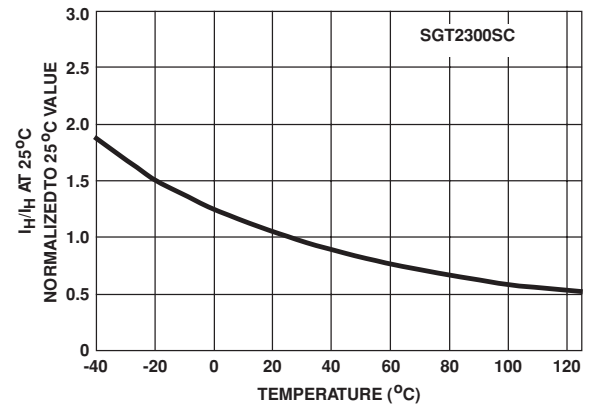

FIGURE 8. TYPICAL HOLDING CURRENT vs JUNCTION TEMPERATURE

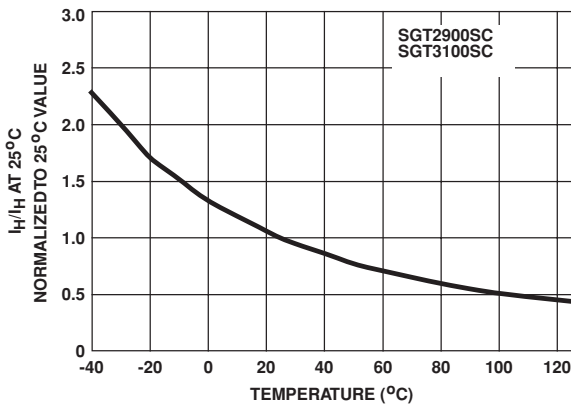

FIGURE 9. TYPICAL HOLDING CURRENT vs JUNCTION TEMPERATURE

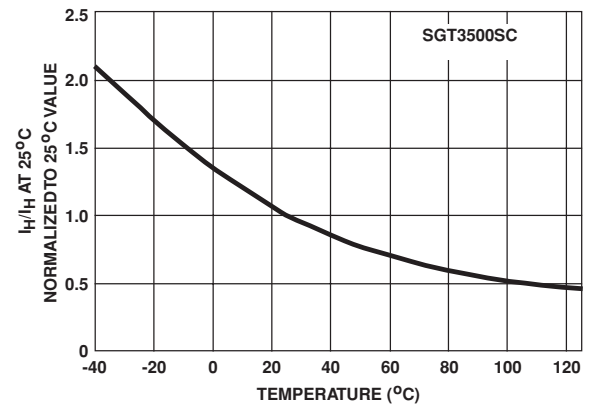

FIGURE 10. TYPICAL HOLDING CURRENT vs JUNCTION TEMPERATURE

Surgeor Thyristors For Telecom Protection

Typical Performance Curves (Continued)

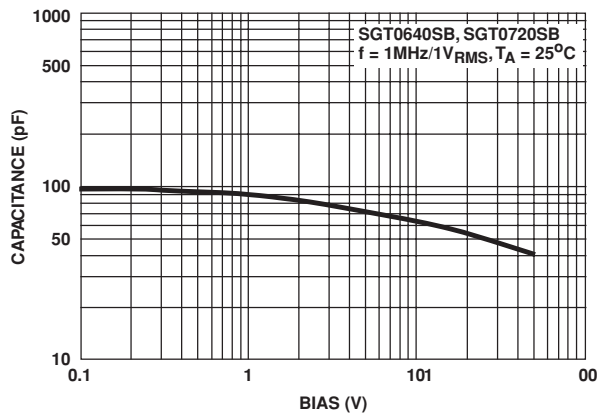

FIGURE 11. TYPICAL CAPACITANCE vs BIAS VOLTAGE

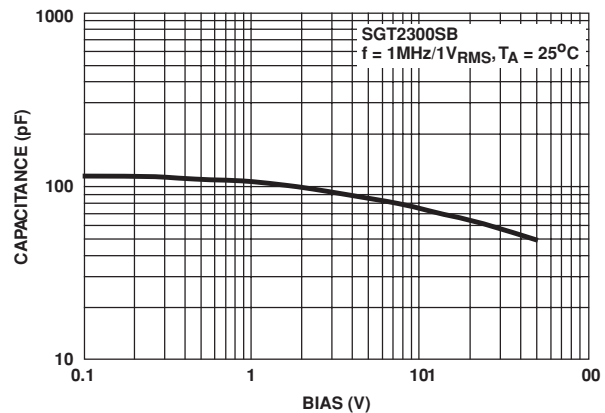

FIGURE 12. TYPICAL CAPACITANCE vs BIAS VOLTAGE

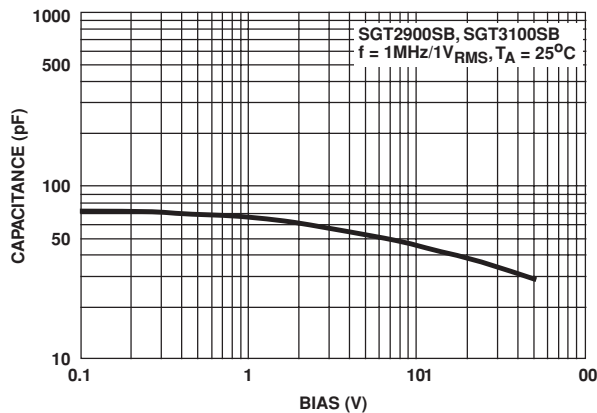

FIGURE 13. TYPICAL CAPACITANCE vs BIAS VOLTAGE

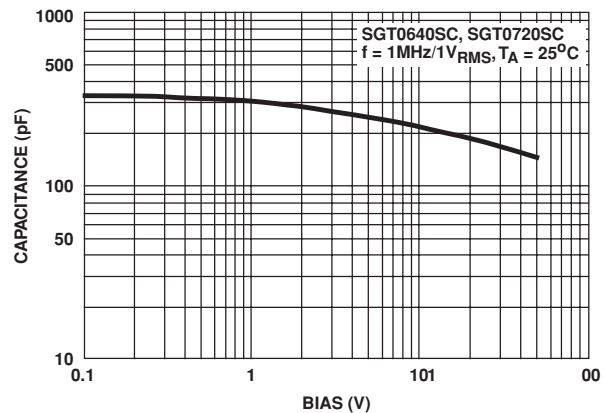

FIGURE 14. TYPICAL CAPACITANCE vs BIAS VOLTAGE

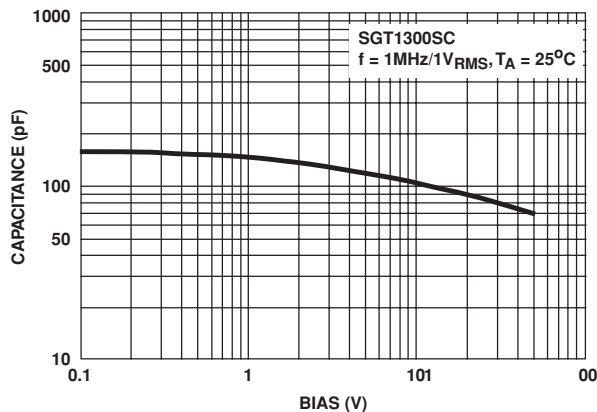

FIGURE 15. TYPICAL CAPACITANCE vs BIAS VOLTAGE

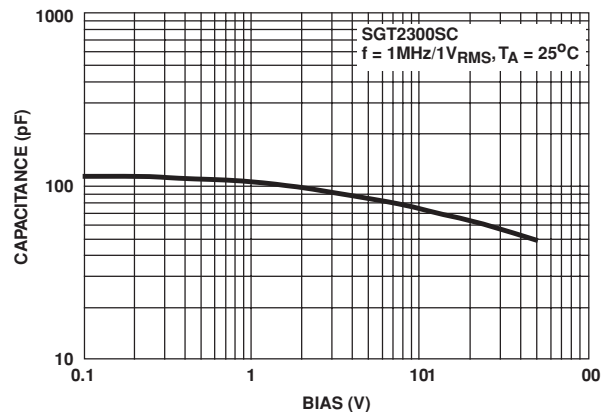

FIGURE 16. TYPICAL CAPACITANCE vs BIAS VOLTAGE

Surgeor Thyristors For Telecom Protection

Typical Performance Curves (Continued)

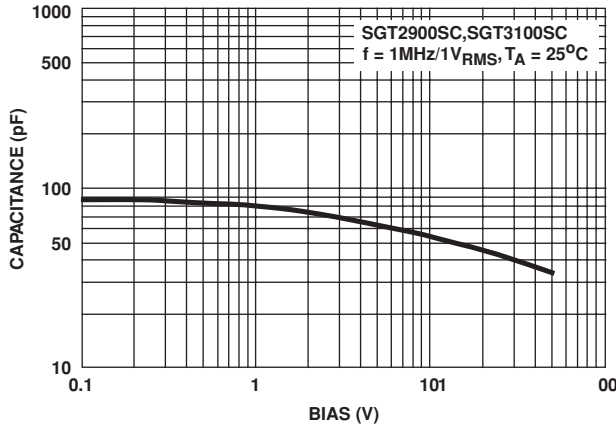

FIGURE 17. TYPICAL CAPACITANCE vs BIAS VOLTAGE

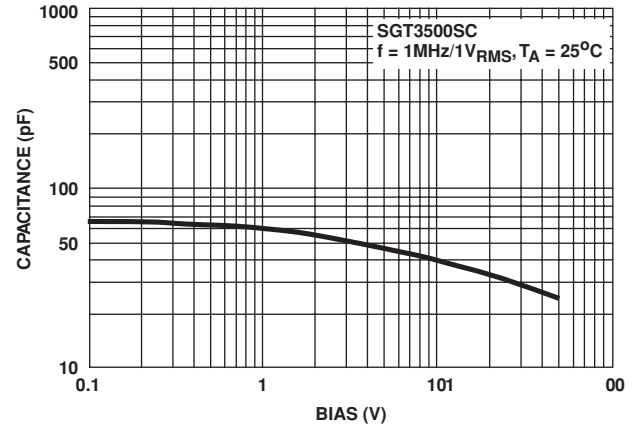

FIGURE 18. TYPICAL CAPACITANCE vs BIAS VOLTAGE

Recommended Surgeors for Typical Industry Standard Transient Specifications

INDUSTRY STANDARD	SPECIFIED PEAK VOLTAGE	SPECIFIED PEAK CURRENT	SPECIFIED CURRENT WAVESHAPES	RECOMMENDED SURGEOR I _{PP} TYPE
GR1089	600V	100A	10 x 1000μs	C
GR1089	1000V	100A	10 x 360μs	C
GR1089	1000V	100A	10 x 1000μs	C
GR1089	2500V	500A	2 x 10μs	C
GR 1089	1000V	25A	10 x 360μs	B, C
FCC PART 68	800V	100A	10 x 560μs	C
FCC PART 68	1500V	200A	10 x 160μs	C
FCC PART 68	1000V	25A	5 x 320μs	B, C
FCC PART 68	1500V	38A	5 x 320μs	B, C
ITU K.20	1000V	25A	5 x 310μs	B, C
ITU K.20	1000V	50A	5 x 310μs	B, C
ITU K.20	4000V	100A	5 x 310μs	C
ITU K.20	4000V	200A	5 x 310μs	C
ITU K.21	1500V	75A	5 x 310μs	B, C
ITU K.21	4000V	200A	5 x 310μs	C
ITU K.21	1000V	25A	5 x 310μs	B, C
ITU K.21	4000V	100A	5 x 310μs	C

Silicon Protection Circuits

Surface Mount Surgeor™ Transient Voltage Suppressors

Surgeor Thyristors For Telecom Protection

Terms and Parameter Definitions

V_{DRM} - Maximim Off-State Voltage (DC or Peak) which may be applied continuously.

I_{DRM} - Maximum Reverse Current measured with V_{DRM} applied. (Off-State Current)

V_T - Forward Voltage drop at the specified Forward Current I_T , in the On-State latched mode.

V_{BO} - Maximum Breakover Voltage at which the device switches to the On-State latched mode.

I_H - Minimum On-State Current required to maintain the device in the latched-on state.

C_O - Terminal Capacitance measured at the specified off-state bias Voltage.

I_{TSM} - Maximum Peak Surge Current at the specified AC cycle waveform.

I_{PP} - Peak Pulse Surge Current rating of a designated waveform.

Ordering Information

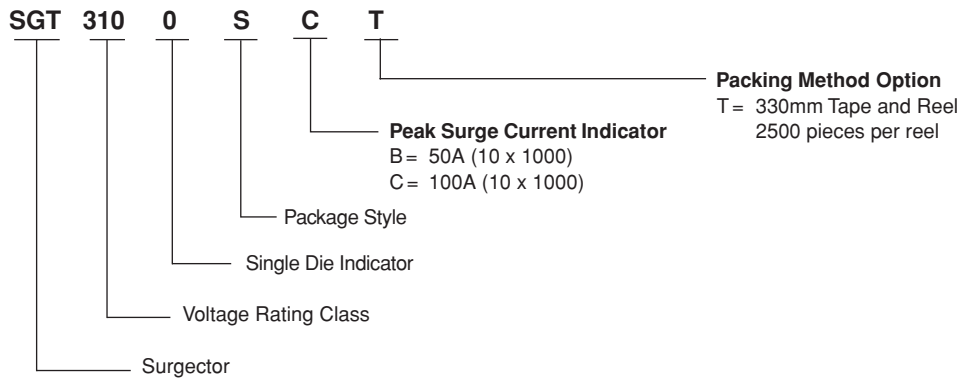

Tape and Reel Specifications (Meets EIA-481-1)

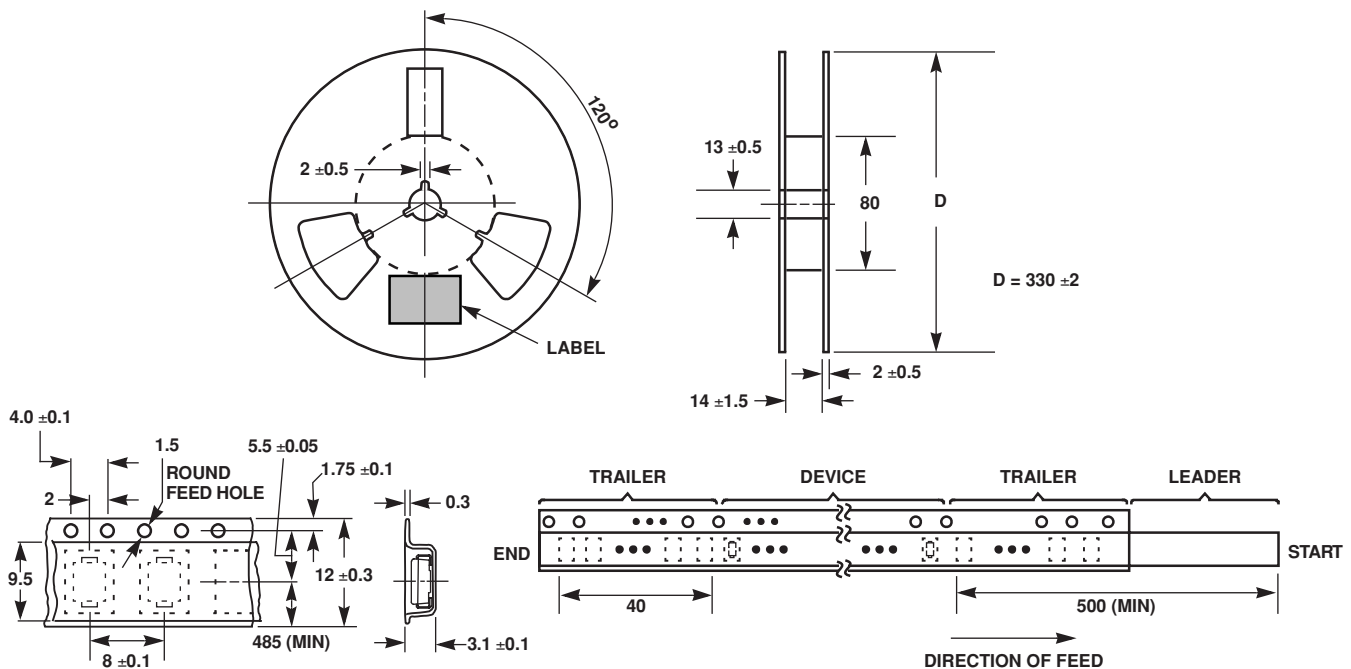

Surgeor Thyristors For Telecom Protection

Branding Layout

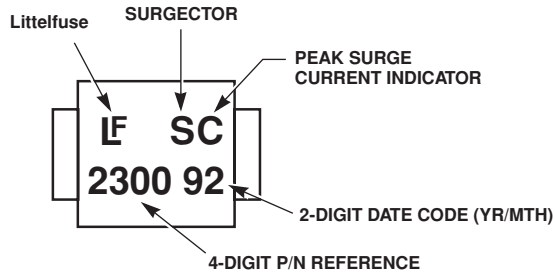

SGT2300SC (TOP VIEW - NOT TO SCALE)

Soldering Recommendations

Surface Mount Surgeors may be soldered with wave or reflow methods, and are compatible with common industry time-temperature profiles that include a preheat stage. When hand soldering, a 30W iron with a 1mm tip is recommended. The temperature should not exceed 300°C or a maximum 5 second duration.

Mechanical Outline Dimensions and Recommended Solder Pad Layout

