

December 1995

Features

- 45A, 60V
- $r_{DS(ON)} = 0.028\Omega$
- *Temperature Compensating* PSPICE Model
- Peak Current vs Pulse Width Curve
- UIS Rating Curve
- +175°C Operating Temperature

Description

The RFG45N06, RFP45N06, RF1S45N06, RF1S45N06SM N-Channel power MOSFETs are manufactured using the MegaFET process. This process, which uses feature sizes approaching those of LSI integrated circuits gives optimum utilization of silicon, resulting in outstanding performance. They were designed for use in applications such as switching regulators, switching converters, motor drivers, relay drivers and emitter switches for bipolar transistors. These transistors can be operated directly from integrated circuits.

PACKAGE AVAILABILITY

PART NUMBER	PACKAGE	BRAND
RFG45N06	TO-247	RFG45N06
RFP45N06	TO-220AB	RFP45N06
RF1S45N06	TO-262AA	F1S45N06
RF1S45N06SM	TO-263AB	F1S45N06

NOTE: When ordering, use the entire part number. Add the suffix, 9A, to obtain the TO-263AB variant in tape and reel, i.e. RF1S45N06SM9A.

Formerly developmental type TA49028.

Symbol

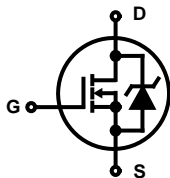

Packages

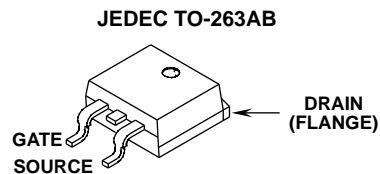
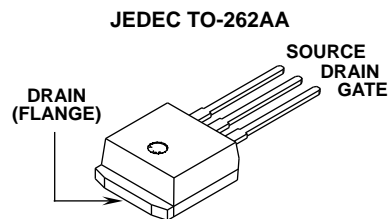
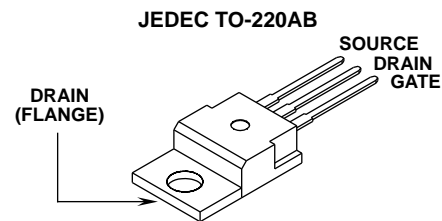
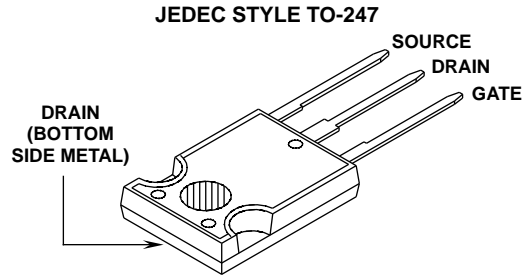

Absolute Maximum Ratings $T_C = +25^\circ\text{C}$

	RFG45N06, RFP45N06 RF1S45N06, RF1S45N06SM	UNITS
Drain Source Voltage	60	V
Drain Gate Voltage	60	V
Gate Source Voltage	± 20	V
Drain Current		
RMS Continuous	45	A
Pulsed Drain Current	Refer to Peak Current Curve	
Pulsed Avalanche Rating	Refer to UIS Curve	
Maximum Avalanche Current	125	A
Power Dissipation		
$T_C = +25^\circ\text{C}$	131	W
Derate above +25°C	0.877	W/°C
Operating and Storage Temperature	-55 to +175	°C

Specifications RFG45N06, RFP45N06, RF1S45N06, RF1S45N06SM

Electrical Specifications $T_C = +25^\circ\text{C}$, Unless Otherwise Specified

PARAMETER	SYMBOL	TEST CONDITIONS	MIN	TYP	MAX	UNITS	
Drain-Source Breakdown Voltage	BV_{DSS}	$I_D = 250\mu\text{A}$, $V_{GS} = 0\text{V}$	60	-	-	V	
Gate Threshold Voltage	$V_{GS(TH)}$	$V_{GS} = V_{DS}$, $I_D = 250\mu\text{A}$	2	-	4	V	
Zero Gate Voltage Drain Current	I_{DSS}	$V_{DS} = 60\text{V}$, $V_{GS} = 0\text{V}$	$T_C = +25^\circ\text{C}$	-	-	1	μA
			$T_C = +150^\circ\text{C}$	-	-	50	μA
Gate-Source Leakage Current	I_{GSS}	$V_{GS} = \pm 20\text{V}$	-	-	100	nA	
On Resistance	$r_{DS(ON)}$	$I_D = 45\text{A}$, $V_{GS} = 10\text{V}$	-	-	0.028	Ω	
Turn-On Time	t_{ON}	$V_{DD} = 30\text{V}$, $I_D = 45\text{A}$ $R_L = 0.667\Omega$, $V_{GS} = +10\text{V}$ $R_{GS} = 3.6\Omega$	-	-	120	ns	
Turn-On Delay Time	$t_{D(ON)}$		-	12	-	ns	
Rise Time	t_R		-	74	-	ns	
Turn-Off Delay Time	$t_{D(OFF)}$		-	37	-	ns	
Fall Time	t_F		-	16	-	ns	
Turn-Off Time	t_{OFF}		-	-	80	ns	
Total Gate Charge	$Q_{G(TOT)}$		$V_{GS} = 0$ to 20V	$V_{DD} = 48\text{V}$, $I_D = 45\text{A}$, $R_L = 1.07\Omega$	-	125	150
Gate Charge at 10V	$Q_{G(10)}$	$V_{GS} = 0$ to 10V	-		67	80	nC
Threshold Gate Charge	$Q_{G(TH)}$	$V_{GS} = 0$ to 2V	-		3.7	4.5	nC
Input Capacitance	C_{ISS}	$V_{DS} = 25\text{V}$, $V_{GS} = 0\text{V}$ $f = 1\text{MHz}$	-	2050	-	pF	
Output Capacitance	C_{OSS}		-	600	-	pF	
Reverse Transfer Capacitance	C_{RSS}		-	200	-	pF	
Thermal Resistance Junction to Case	$R_{\theta JC}$		-	-	1.14	$^\circ\text{C/W}$	
Thermal Resistance Junction to Ambient	$R_{\theta JA}$		-	-	80	$^\circ\text{C/W}$	

Source-Drain Diode Specifications

PARAMETER	SYMBOL	TEST CONDITIONS	MIN	TYP	MAX	UNITS
Forward Voltage	V_{SD}	$I_{SD} = 45\text{A}$	-	-	1.5	V
Reverse Recovery Time	t_{RR}	$I_{SD} = 45\text{A}$, $dI_{SD}/dt = 100\text{A}/\mu\text{s}$	-	-	125	ns

Typical Performance Curves

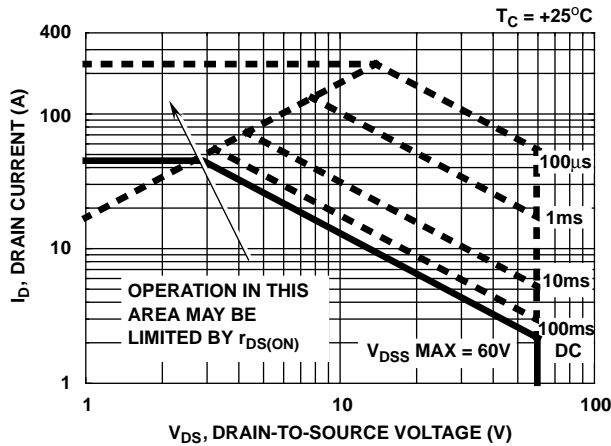

FIGURE 1. SAFE- OPERATING AREA CURVE

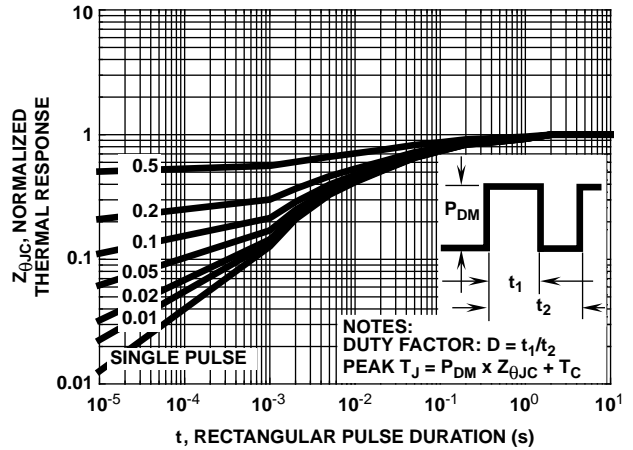

FIGURE 2. NORMALIZED MAXIMUM TRANSIENT THERMAL IMPEDANCE

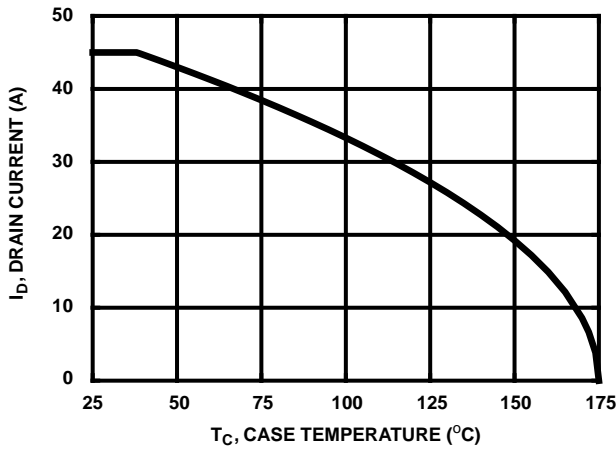

FIGURE 3. MAXIMUM CONTINUOUS DRAIN CURRENT vs TEMPERATURE

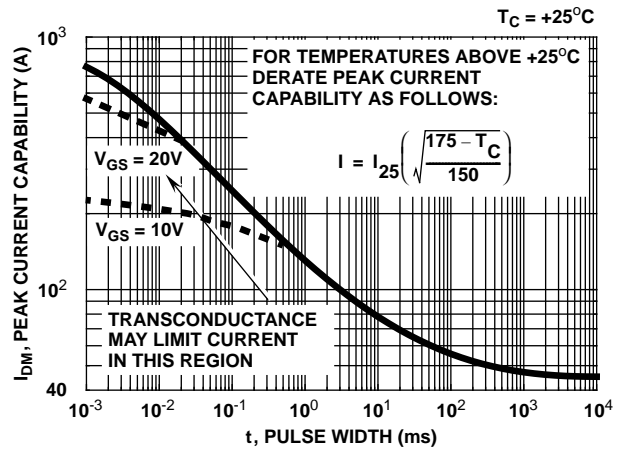

FIGURE 4. PEAK CURRENT CAPABILITY

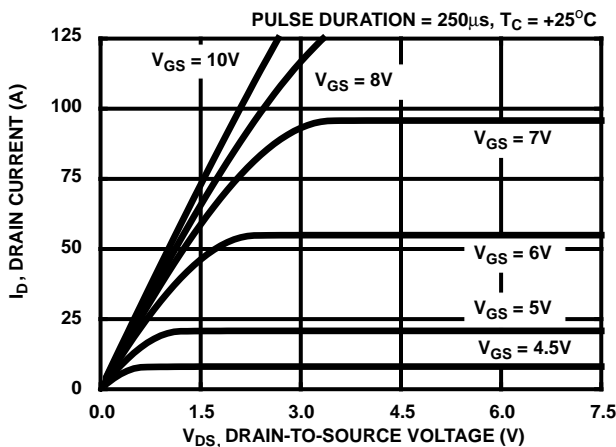

FIGURE 5. TYPICAL SATURATION CHARACTERISTICS

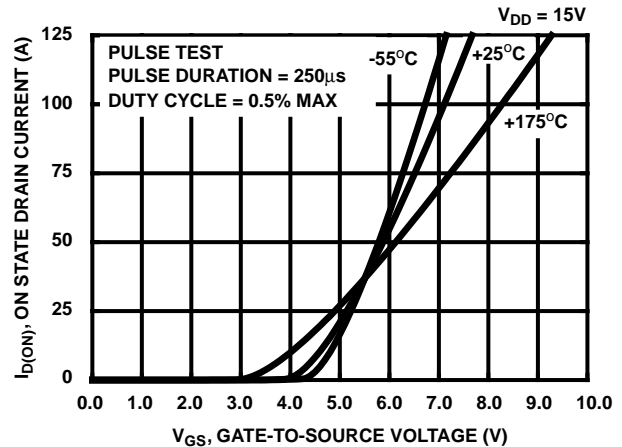

FIGURE 6. TYPICAL TRANSFER CHARACTERISTICS

Typical Performance Curves (Continued)

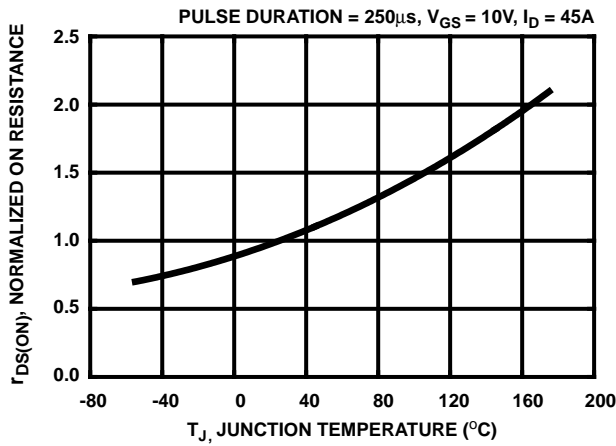

FIGURE 7. NORMALIZED $r_{DS(ON)}$ vs JUNCTION TEMPERATURE

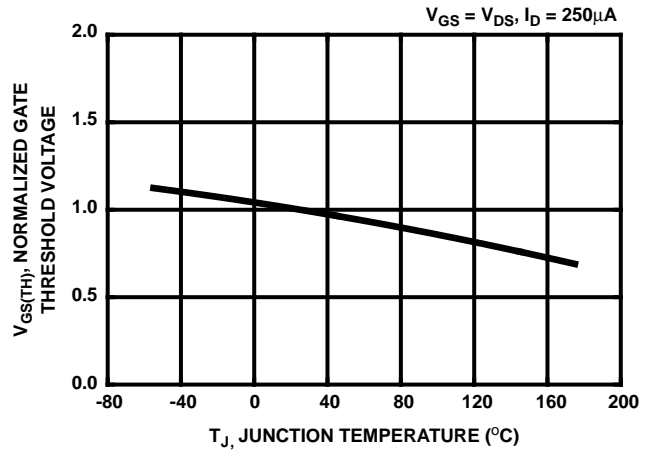

FIGURE 8. NORMALIZED GATE THRESHOLD VOLTAGE vs TEMPERATURE

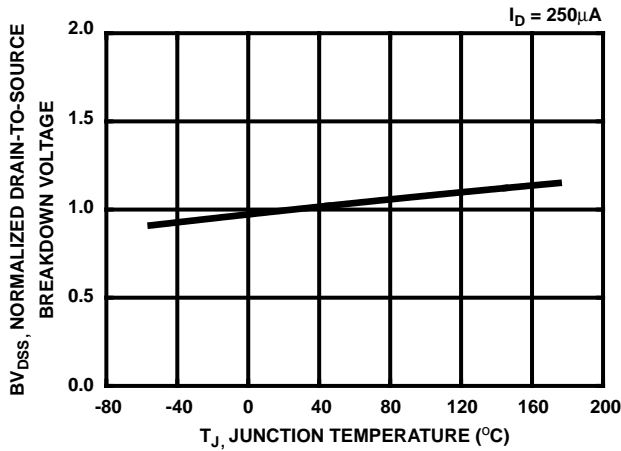

FIGURE 9. NORMALIZED DRAIN SOURCE BREAKDOWN VOLTAGE vs TEMPERATURE

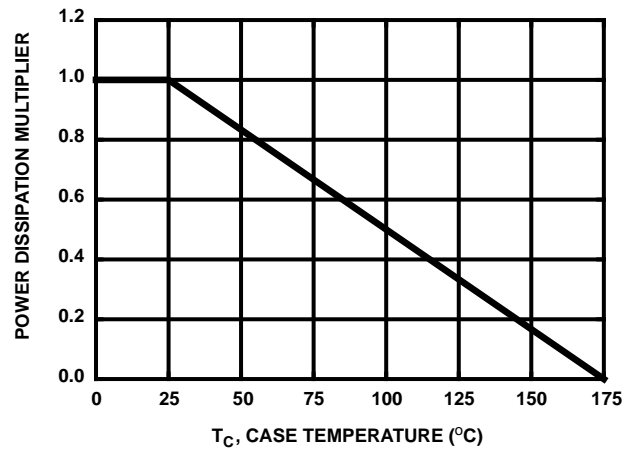

FIGURE 10. NORMALIZED POWER DISSIPATION vs TEMPERATURE DERATING CURVE

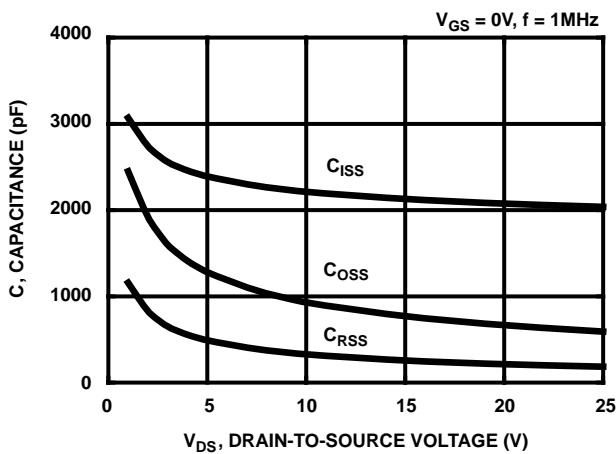

FIGURE 11. TYPICAL CAPACITANCE vs VOLTAGE

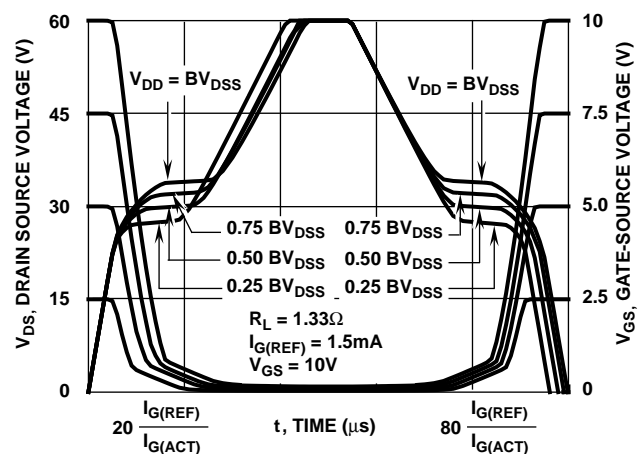

FIGURE 12. NORMALIZED SWITCHING WAVEFORMS FOR CONSTANT GATE CURRENT. REFER TO APPLICATION NOTE AN7254 AND AN7260

Typical Performance Curves (Continued)

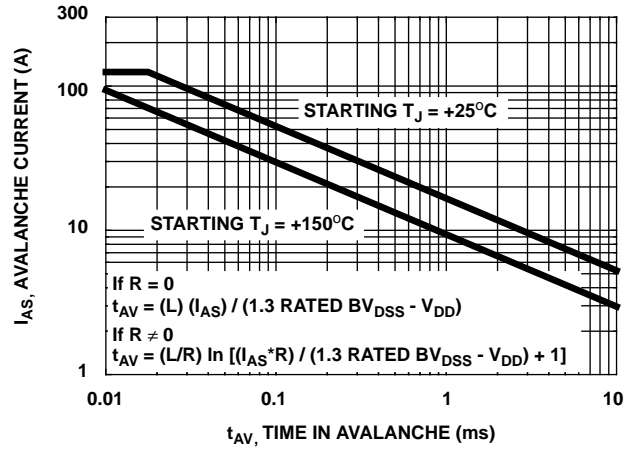

FIGURE 13. UNCLAMPED INDUCTIVE SWITCHING

Test Circuits and Waveforms

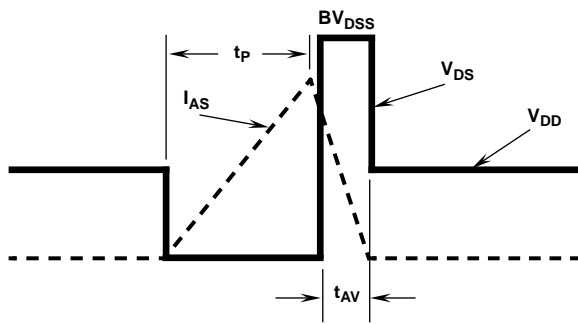

FIGURE 14. UNCLAMPED ENERGY WAVEFORMS

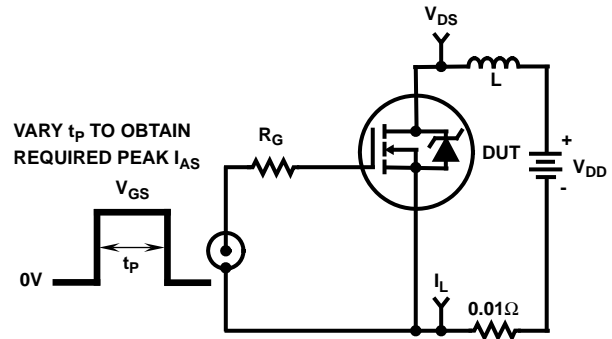

FIGURE 15. UNCLAMPED ENERGY TEST CIRCUIT

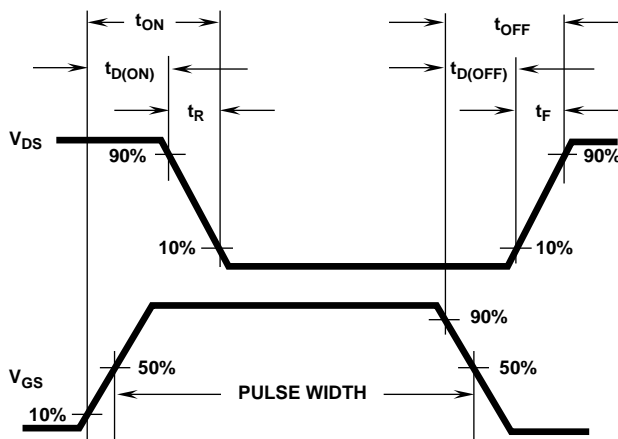

FIGURE 16. RESISTIVE SWITCHING WAVEFORMS

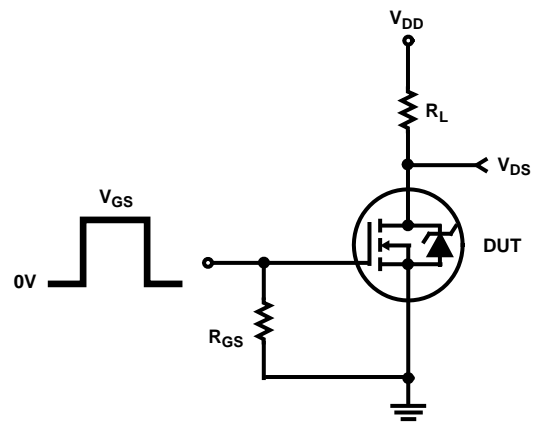

FIGURE 17. RESISTIVE SWITCHING TEST CIRCUIT

RFG45N06, RFP45N06, RF1S45N06, RF1S45N06SM

**Temperature Compensated PSPICE Model for the
RFG45N06, RFP45N06, RF1S45N06, RF1S45N06SM**

.SUBCKT RFP45N06 2 1 3

REV 1/18/93

*NOM TEMP = +25°C

CA 12 8 3.49E-9
CB 15 14 3.8E-9
CIN 6 8 2E-9

DBODY 7 5 DBDMOD
DBREAK 5 11 DBKMOD
DPLCAP 10 5 DPLCAPMOD

EBREAK 11 7 17 18 66.5
EDS 14 8 5 8 1
EGS 13 8 6 8 1
ESG 6 10 6 8 1
EVTO 20 6 18 8 1

IT 8 17 1

LDRAIN 2 5 1E-9
LGATE 1 9 5.65E-9
LSOURCE 3 7 4.13E-9

MOS1 16 6 8 8 MOSMOD M=0.99
MOS2 16 21 8 8 MOSMOD M=0.01

RBREAK 17 18 RBKMOD 1
RDRAIN 5 16 RDSMOD 3.58E-3
RGATE 9 20 0.681
RIN 6 8 1E9
RSOURCE 8 7 RDSMOD 13.6E-3
RVTO 18 19 RVTOMOD 1

S1A 6 12 13 8 S1AMOD
S1B 13 12 13 8 S1BMOD
S2A 6 15 14 13 S2AMOD
S2B 13 15 14 13 S2BMOD

VBAT 8 19 DC 1
VTO 21 6 0.92

.MODEL DBDMOD D (IS=8.2E-13 RS=7.86E-3 TRS1=2.26E-3 TRS2=2.90E-6 CJO=2.07E-9 TT=5.72E-8)
.MODEL DBKMOD D (RS=1.93E-1 TRS1=5.13E-4 TRS2=-2.15E-5)
.MODEL DPLCAPMOD D (CJO=1.25E-9 IS=1E-30 N=10)
.MODEL MOSMOD NMOS (VTO=3.862 KP=55.57 IS=1E-30 N=10 TOX=1 L=1U W=1U)
.MODEL RBKMOD RES (TC1=1.12E-3 TC2=-5.18E-7)
.MODEL RDSMOD RES (TC1=4.64E-3 TC2=1.58E-5)
.MODEL RVTOMOD RES (TC1=-4.27E-3 TC2=-6.55E-6)
.MODEL S1AMOD VSWITCH (RON=1E-5 ROFF=0.1 VON=-6.5 VOFF=-1.7)
.MODEL S1BMOD VSWITCH (RON=1E-5 ROFF=0.1 VON=-1.7 VOFF=-6.5)
.MODEL S2AMOD VSWITCH (RON=1E-5 ROFF=0.1 VON=-3.0 VOFF=2)
.MODEL S2BMOD VSWITCH (RON=1E-5 ROFF=0.1 VON=2.0 VOFF=-3.0)

.ENDS

NOTE: For further discussion of the PSPICE model consult **A New PSPICE Sub-circuit for the Power MOSFET Featuring Global Temperature Options**; authors, William J. Hepp and C. Frank Wheatley.

