

RD8

TinySwitch™

Reference Design Board

85 to 265 VAC Input, 3 W Output



Low Cost Production Worthy AC Adapter Reference Design

- Cost competitive with linear solutions (regulated 50/60 Hz transformers)
- Lowest component count switching solution
- Ultra low no-load power consumption (30/70 mW @ 115/230 VAC)
- Simple low cost two-winding transformer
- Greater than 72% efficiency
- Low average EMI, only one inductive component required for EMI filtering
- Small size

Designed for World Wide Operation

- Designed for IEC/UL safety requirements
- Meets FCC/VDE Class B EMI specifications
- Wide range input voltage

Description

The RD8 reference design board is an example of a low cost production worthy design for an AC wall adapter or similar applications requiring small size, high efficiency, and low cost. The RD8 utilizes the TNY254 member of the *TinySwitch* family of low cost Off-line Switchers from Power Integrations. It is intended to help *TinySwitch* users develop their products quickly by providing a production ready design which needs little or no modification to meet system requirements. The RD8 is designed to replace conventional linear AC wall adapters, offering universal input range, smaller size, and high efficiency, all at a competitive cost. The RD8 is cost-competitive with linear solutions (regulated 50/60 Hz transformers).

The unique ON/OFF control scheme of *Tinyswitch* virtually eliminates energy consumption at no load. Typical linear wall adapters consume 1-4 watts at no load, which costs \$1-\$4 per year (based on \$0.12/kWhr). In comparison, a typical *TinySwitch* supply consumes 30-70 mW at no load, offering substantial energy savings.

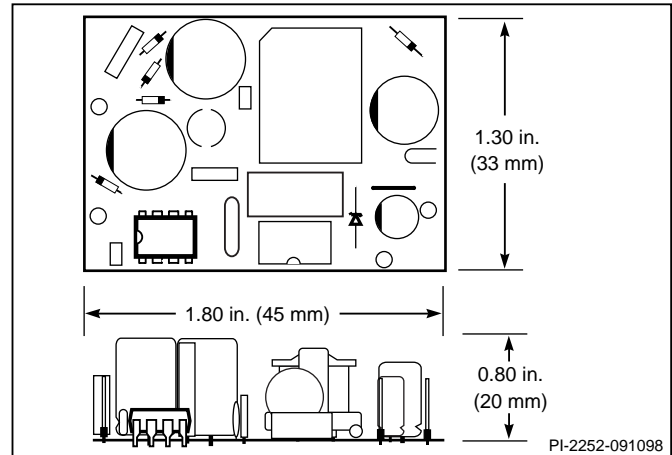
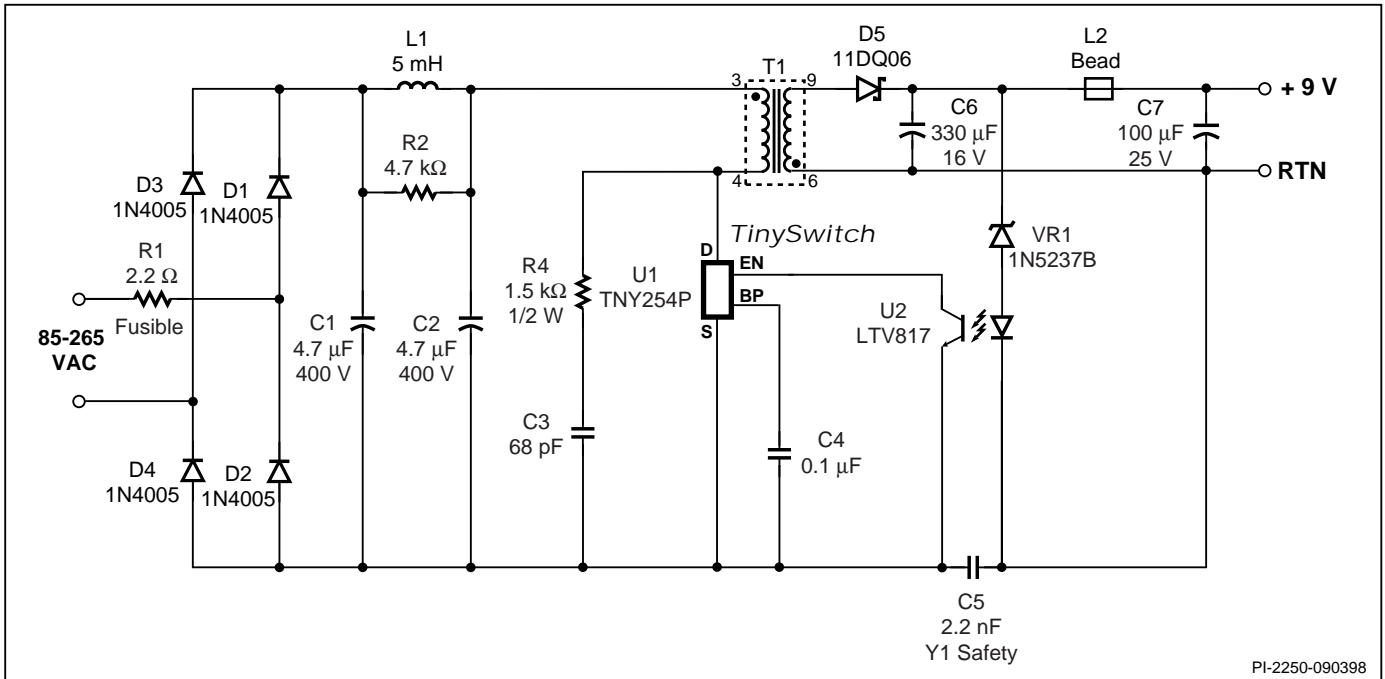

Figure 1. RD8 Board Overall Physical Dimensions.

PARAMETER	LIMITS
Input Voltage Range	85 to 265 VAC
Input Frequency Range	47 to 440 Hz
Temperature Range	0 to 50°C
Output Voltage ($I_o = 0.33$ A)	9 V \pm 7%*
Output Power (continuous)	3 W
Line Regulation (85-265 VAC)	\pm 0.5%
Load Regulation (0%-100%)	\pm 1%
Efficiency ($P_o = 3$ W)	72% (min)
Standby Power Consumption (115/230 VAC)	30/70 mW (typical)
Output Ripple Voltage	\pm 75 mV
Safety	IEC 950 / UL1950
EMI	VFG243B (Quasi-Peak) VFG46 B (Average) CISPR22 B FCC Part 15 "B"

* Can be improved to \pm 5% by using a more accurate Zener (\pm 2%).

Table 1. Table of Key Electrical Parameters.



PI-2250-090398

Figure 2. Schematic Diagram of the 3 W RD8 Power Supply.

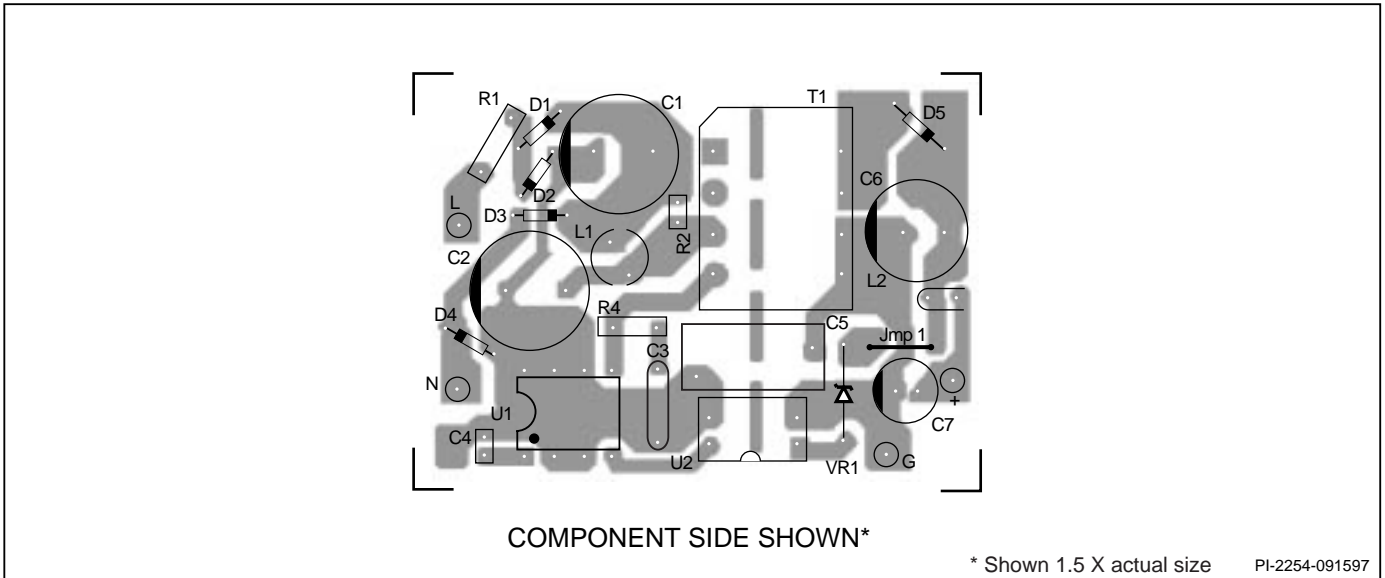

* Shown 1.5 X actual size PI-2254-091597

Figure 3. Component Legend for the RD8.

General Circuit Description

The RD8 is a low-cost flyback switching power supply using the TNY254P integrated circuit. The circuit shown in Figure 2 details a 9 V, 3 W power supply that operates from 85 to 265 VAC input voltage, suitable for replacing conventional linear supplies in cost-sensitive applications such as AC wall adapters.

AC power is rectified and filtered by D1-4, C1, and C2 to create

the high voltage DC bus applied to the primary winding of T1. R4 and C3 clamp the primary leakage spike and also reduce EMI. At this power level, a simple RC network is sufficient for snubbing leakage spikes. Because of the relatively low switching frequency of *TinySwitch* (44 kHz), and its ON/OFF control method, the additional capacitive loading of the RC snubber network has a much smaller effect on efficiency than for conventional PWM switchers running at higher switching frequencies. Since *TinySwitch* runs in current limit mode at all times regardless of output load, the worst case leakage spike

Component Listing

Reference	Value	Part Number	Manufacturer
C1, C2	4.7 μ F, 400 V	475CKH400M	Illinois Capacitors
C3	68 pF, 1 kV	DD680	Philips
C4	0.1 μ F, 50 V	RPE121Z5U104M50V	Murata
C5	2.2 nF, 250 VAC Y1	440LD22	Cera-Mite
C6	330 μ F, 16 V Low ESR	ECA-1CFQ331L	Panasonic
C7	100 μ F, 25 V	ECE-A1EGE101	Panasonic
D1-4	600 V, 1 A	1N4005	General Instrument
D5	60 V, 1A, Schottky	11DQ06	International Rectifier
L1	5.5 mH (min), 0.1 A		
L2	Ferrite Bead, 3.5 X 11.4 mm	2743008112	Fair-Rite
R1	2.2 Ω , 1 W	BW2F2.2 Ω 5%	RCD
R2	4.7 k Ω , 1/4 W	5043CX4K700J	Philips
R4	1.5 k Ω , 1/2 W, 5%	5053CX1K500J	Philips
T1*		TRD8	Custom
U1		TNY254P	Power Integrations
U2	Optocoupler	LTV817	Liteon
VR1	8.2 V 5% Zener	1N5237B	Motorola

* For transformer sources, please visit the Power Integrations website at www.powerint.com.

Table 2. Parts List for the RD8.

and the appropriate values of R4 and C3 required for snubbing are easily determined. Traditional RCD or diode-Zener clamping can also be used at a small additional cost for higher efficiency. The secondary winding of T1 is rectified and filtered by D5, C6, L2, and C7 to create the 9 V output voltage.

Zener diode VR1 and U2 sense the output voltage and provide feedback to *TinySwitch* U1. The output voltage is set by the combined voltage drops of Zener diode VR2 and the LED of U2. Other output voltages are also possible by adjusting the transformer turns ratio and the value of Zener diode VR1. A resistor can be placed across the LED of U2 to provide additional bias current (1-5 mA) to VR1. This improves regulation and voltage accuracy. The extra bias current slightly increases no load power consumption (15-75 mW).

Capacitors C1, C2, L1, R2, and Y1-capacitor C5 provide EMI filtering for the power supply. At lower output power levels (or for supplies designed to operate at 115 VAC only), L1 can be replaced with a resistor, reducing system cost at the expense of slightly lower efficiency.

Resistor R1 is a fusible resistor for protection against primary fault conditions. This is a low cost alternative to a standard fuse, accepted by safety agencies.

The RD8 power supply is designed to run in discontinuous conduction mode, with the primary peak current set by the TNY254P internal current limit. In this mode of operation, the

on-time for each switching cycle is set by the transformer primary inductance, *TinySwitch* current limit and the high voltage DC input bus. Output regulation is accomplished by skipping switching cycles in response to an ON/OFF feedback signal applied to the ENABLE pin. This differs significantly from traditional PWM schemes that control the duty factor of each switching cycle. Due to the ON/OFF nature of the *TinySwitch* control scheme, the feedback optocoupler operates in switching rather than in linear mode. Therefore the current transfer ratio is not a critical factor as long as the optocoupler provides enough current (50 μ A) to activate the ENABLE pin of the *TinySwitch*. This allows a low cost ungraded optocoupler to be used.

For 115 V applications, 200 V rated capacitors can be used for C1 and C2, and D5 can be replaced with a 40 V device (1N5819 or similar). If 200 V capacitors are used, then L1 can be replaced with a resistor.

The circuit performance data shown in Figures 4-17 were measured with AC voltage applied to the RD8.

Load Regulation (Figure 4) – The change in the DC output voltage for a given change in output current is referred to as load regulation. RD8 output voltage stays within $\pm 1\%$ of nominal from 0% to 100% of rated load current. The *TinySwitch* regulation scheme enables this level of performance without the use of a preload. The slight rise in output voltage at no load is due to an increase in the voltage drop across VR1, caused by

General Circuit Description (cont.)

higher average Zener current. This effect can be corrected by adding a Zener bias resistor across the LED side of U2. This resistor also provides a small preload, further improving no load regulation.

Line Regulation (Figure 5) - The change in the DC output voltage for a given change in the AC input voltage is called line regulation. The maximum change in output voltage versus line for the RD8 is within $\pm 0.5\%$.

Efficiency (Line Dependent) – Efficiency is the ratio of the output power to the input power. The curves in Figures 6 and 7 show the efficiency as a function of input voltage. Note that the efficiency is relatively constant over the entire input voltage range.

Efficiency (Load Dependent) – The curves in Figures 8 and 9 show how the efficiency changes with output power for 115 VAC and 230 VAC inputs. Due to the *TinySwitch* regulation scheme, the efficiency is relatively constant from 0-100% of output load.

Power Supply Turn On Sequence –The waveforms shown in Figure 10 illustrate the relationship between the high-voltage DC bus and the 9 V output voltage. Since the *TinySwitch* internal power consumption is extremely small and is derived entirely from the DRAIN, the supply starts switching almost as soon as power is applied, as shown in Figure 10. The output achieves regulation approximately 8 ms after power is applied, with no overshoot.

Power Supply Turn Off Sequence - Figure 11 shows the decay of the 9 V output when the AC input is removed. The 9 V decays monotonically to zero after AC power is removed, with no spurious pulses.

Output Ripple - Line frequency ripple voltage is shown in Figure 12 for 115 VAC input and 3 W output. Switching frequency ripple voltage is shown in Figure 13 for the same test condition. In Figure 13, note the skipped pulses due to the *TinySwitch* ON/OFF control.

Load Transient Response - The output transient response to a step load change from 0.26 to 0.33 A (75% to 100%) is shown in Figure 14. Note that the load transient is extremely small (< 20 mV), and recovers within 100 μ s. The small step in the load response is due to the finite load regulation of the RD8.

No Load Power Consumption - Figure 15 shows no load power consumption as a function of input voltage. The no load power consumption for the RD8 is only 10 to 20% of the standby power consumption of a typical linear power supply.

The RD8 is designed to meet worldwide safety and EMI (FCC B and VDE B) specifications. Measured conducted emissions are shown in Figure 16 for 115 VAC and Figure 17 for 230 VAC. In the RFI measurements performed on the RD8, peak measurements were applied to the quasi-peak limits specified by the test agencies. A peak measurement is more stringent than a quasi-peak or average measurement, since there is no averaging of the EMI signal from the supply under test. Peak measurements are also simpler and easier to perform using a standard spectrum analyzer.

Figure 16 shows the results of a peak EMI scan at 115 VAC and full output load, compared to the FCC B quasi-peak limit. The RD8 passes the FCC B quasi-peak limits with margin using a peak EMI measurement. Applying quasi-peak measurement to the RD8 will result in EMI levels 3-4 dB lower than shown in Figure 16. This is true because the RD8 skips pulses to achieve regulation, resulting in substantially lower quasi-peak and average EMI levels than for a peak measurement.

Most European EMI standards specify test limits for both quasi-peak and average measurement. The supply under test must pass both the average and quasi-peak limits to achieve certification. Figure 17 shows peak and average EMI scans performed at 230 VAC input and full load, compared to the VFG243 B quasi-peak limit and the VFG46 B average limit. The VFG243 and VFG46 specifications incorporate the same test limits as CISPR22, but also include frequencies below 150 kHz. The RD8 peak measurement passes the VFG 243 B quasi-peak limit with substantial margin, and almost passes the VFG46 B average limit. The average measurement passes the VFG46 B average limit with a minimum of 6 dB margin.

In both the 115 V and 230 V measurements, there is almost no EMI at frequencies of 4 MHz and above. This is due in part to the relatively low operating frequency of *TinySwitch* (44 kHz nominal). The lack of high frequency emissions allows easy compliance with international radiated emissions limits.

Transformer Specification

The electrical specifications and construction details for transformer TRD8 are shown in Figures 18 and 19. Transformer TRD8 is supplied with the RD8 reference design board. Since no auxiliary bias winding is required to power *TinySwitch*, the transformer design is very simple, requiring only a primary and secondary winding.

The TRD8 design utilizes an EE16 core and a triple insulated wire secondary winding. The use of triple insulated wire allows the transformer to be constructed using a smaller core and bobbin than a conventional magnet wire design due to the

elimination of the margins required for safety spacing in a conventional design.

If a conventional margin wound transformer is desired, the design of Figures 20-21 can be used. This design (TRD8-1) uses an EEL16 core and bobbin to accommodate the 6 mm total creepage distance required to meet international safety standards

when using magnet wire rather than triple insulated wire. It has the same pinout and printed circuit foot print as TRD8. The margin wound transformer is approximately 50% taller than the triple insulated wire design due to the inclusion of creepage margins required to meet international safety standards.

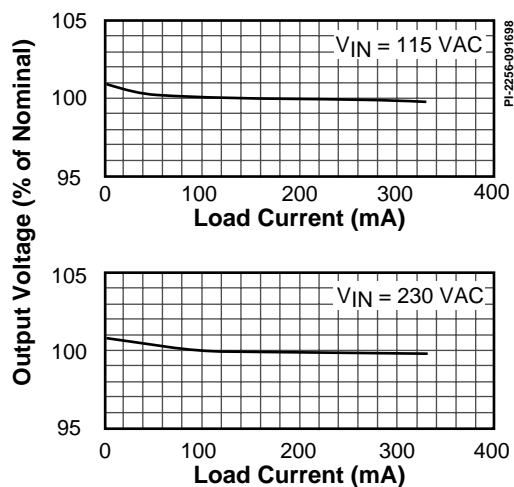

Figure 4. Load Regulation.

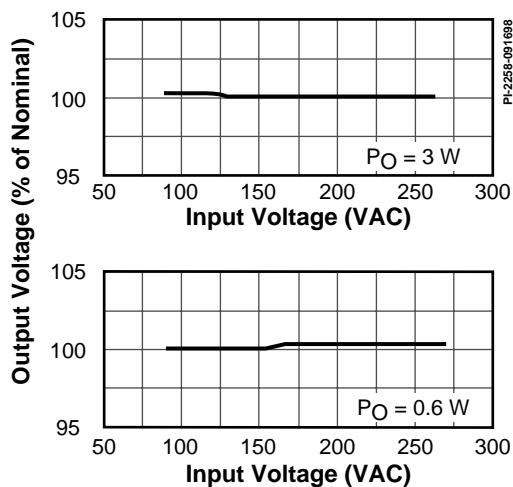

Figure 5. Line Regulation.

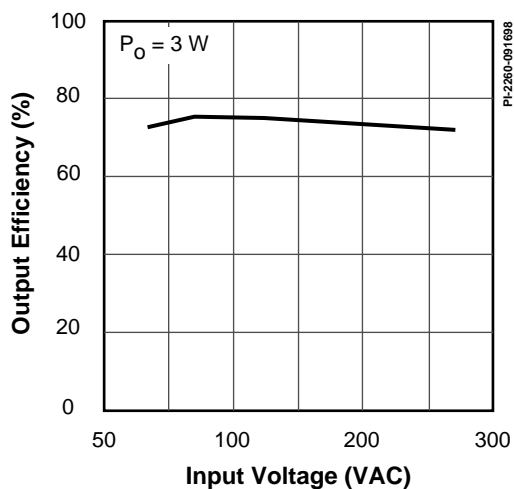

Figure 6. Efficiency vs. Input Voltage, 3 W Output.

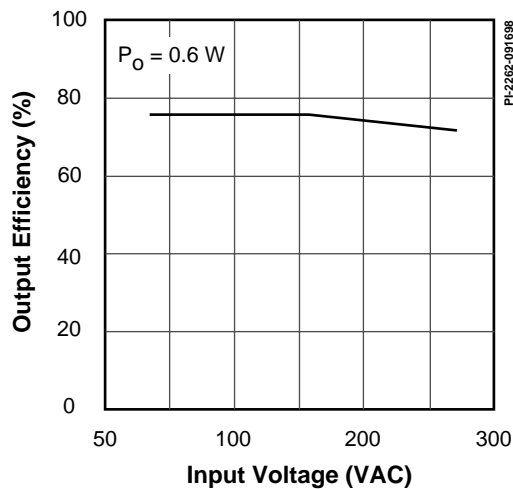

Figure 7. Efficiency vs. Input Voltage, 0.6 W Output.

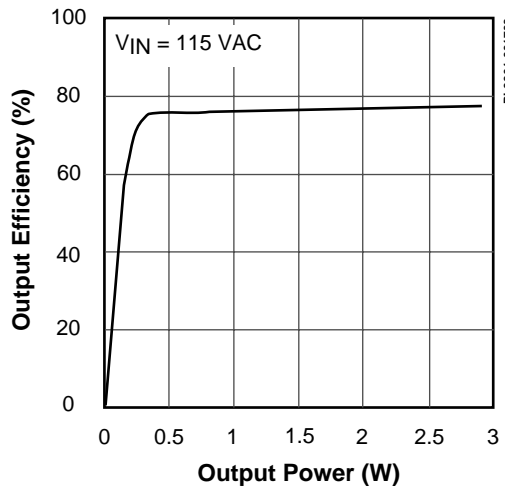

Figure 8. Efficiency vs. Output Power, 115 VAC Input.

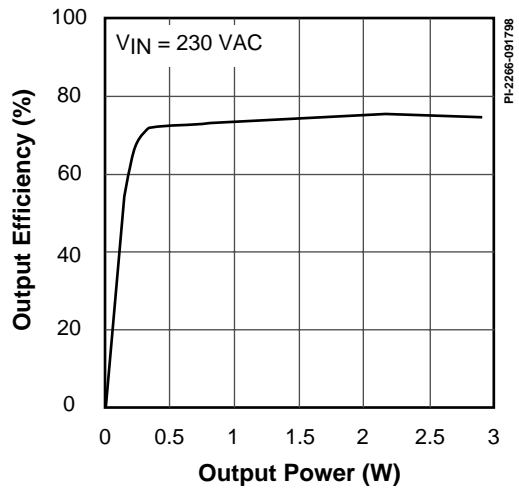

Figure 9. Efficiency vs. Output Power, 230 VAC Input.

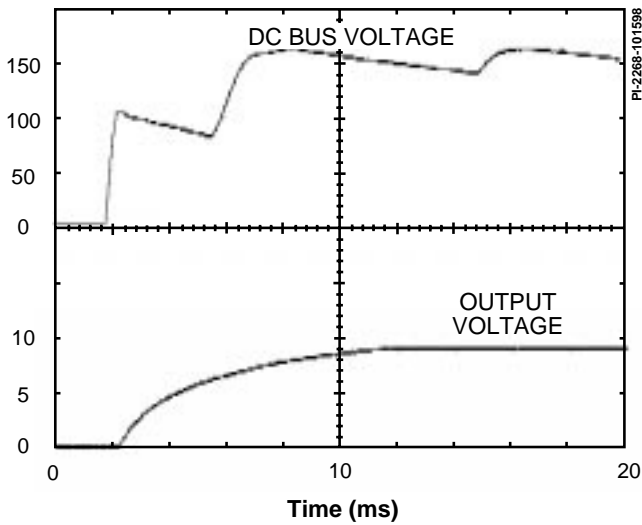

Figure 10. Turn On Delay, 115 VAC Input.

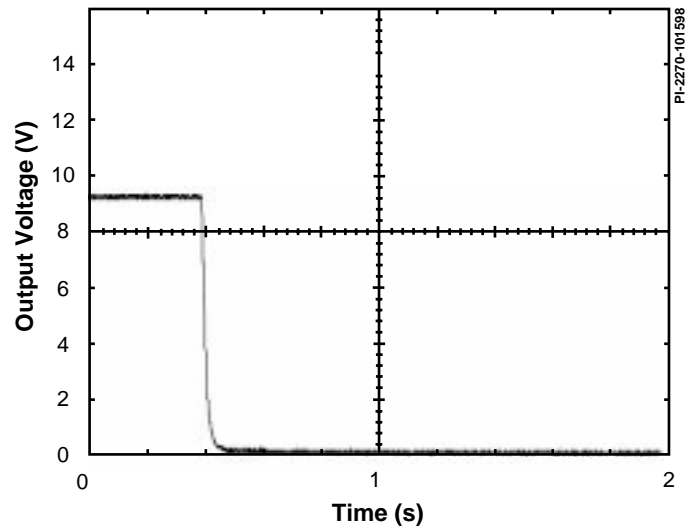

Figure 11. Output Turn Off.

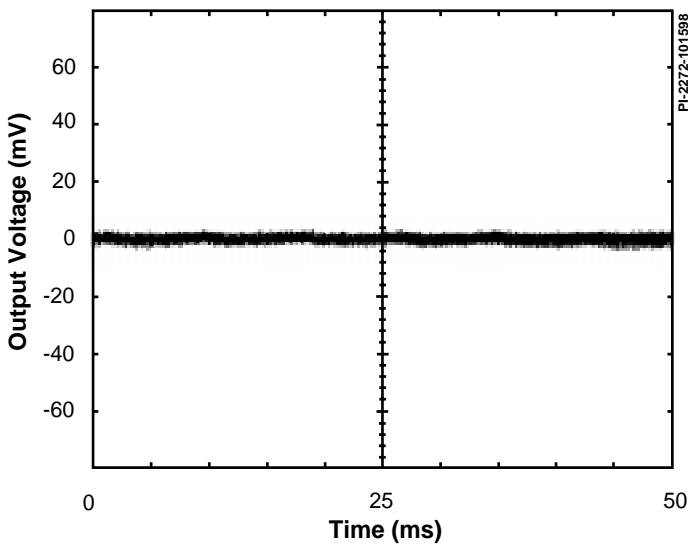

Figure 12. Line Frequency Ripple, 115 VAC Input, 3 W Output.

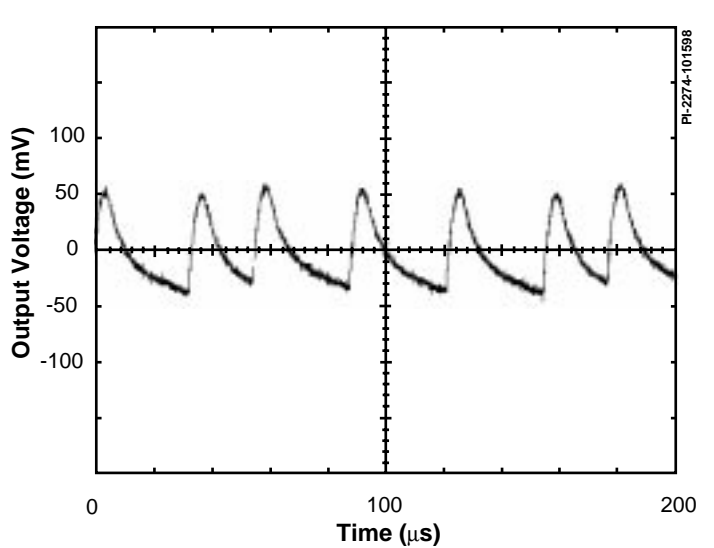

Figure 13. Switching Frequency Ripple, 115 VAC Input, 3 W Output.

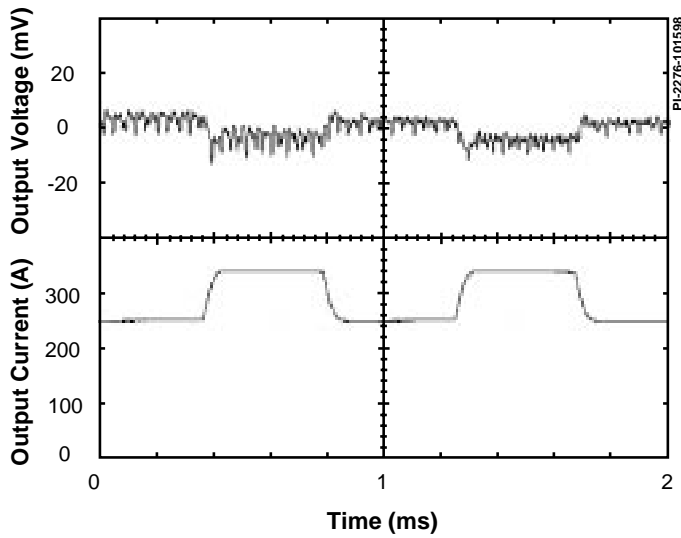

Figure 14. Transient Load Response (75% to 100% of load).

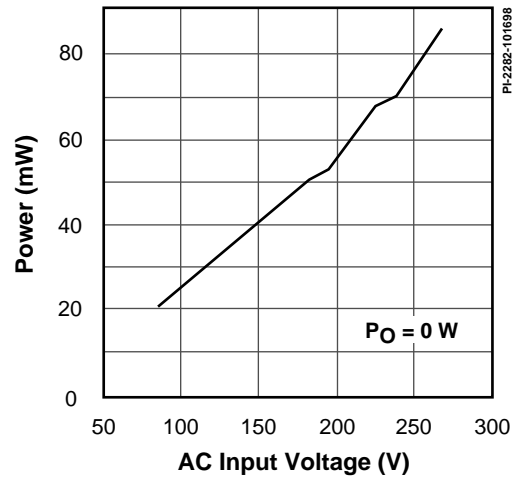

Figure 15. No Load Power Consumption.

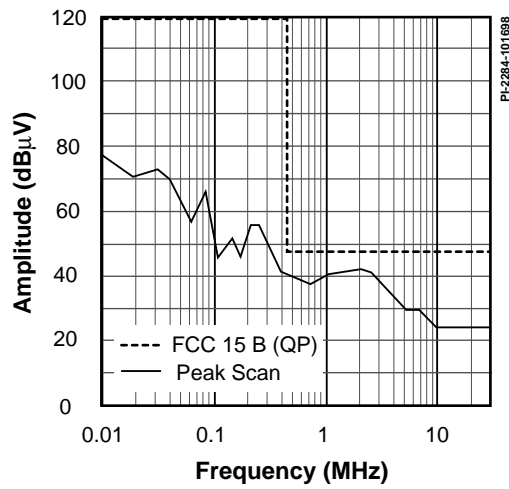

Figure 16. EMI Characteristics at 115 VAC Input.

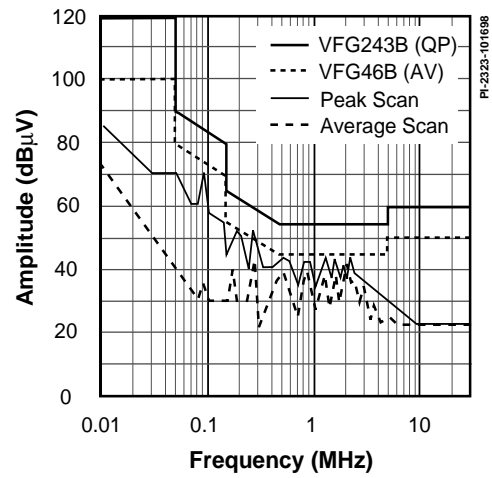
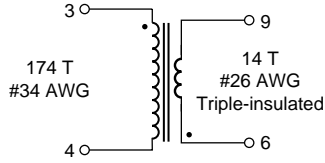
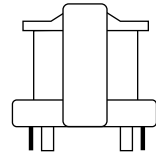
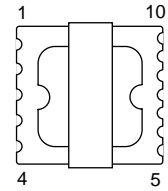

Figure 17. EMI Characteristics at 230 VAC Input.

TRIPLE INSULATED SECONDARY TRANSFORMER (TRD8)



PIN	FUNCTION
3	HIGH-VOLTAGE DC BUS
4	<i>TinySwitch</i> DRAIN
6	SECONDARY RETURN
9	OUTPUT



CORE# - PC40 EE16-Z (TDK)
 GAP FOR A_L OF 112 nH/T²
 BOBBIN# - YC-1607 (Ying Chin Co., Ltd.)

ELECTRICAL SPECIFICATIONS		
Electrical Strength	60 Hz, 1 minute, from pins 1-4 to pins 5-10	3000 VAC
Creepage	Between pins 1-4 and pins 5-10	6.00 mm (min)
Primary Inductance	All windings open	3400 μ H \pm 10%
Resonant Frequency	All windings open	420 kHz (min)
Primary Leakage Inductance	Pins 6 and 9 shorted	120 μ H (max)

NOTE: All inductance measurements should be made at 40 kHz

PI-2226-082498

Figure 18. Electrical specification of transformer TRD8.

TRIPLE INSULATED SECONDARY TRANSFORMER CONSTRUCTION

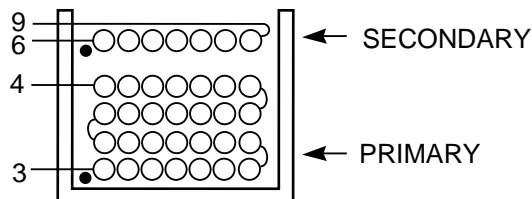

WINDING INSTRUCTIONS

Primary	Start at Pin 3. Wind 174 turns of 34 AWG heavy nyleze wire in four layers. Finish on Pin 4.
Secondary Winding	Start at Pin 6. Wind 14 turns of 26 AWG triple insulated wire from left to right. Finish on Pin 9.
Final Assembly	Assemble and secure core halves. Glue according to Power Integrations instructions (see Power Integrations website: www.powerint.com).

* Triple insulated wire sources.

P/N: T27A01TXXX-3
 Rubudue Wire Company
 5150 E. La Palma Avenue
 Suite 108
 Anaheim Hills, CA 92807
 (714) 693-5512
 (714) 693-5515 FAX

P/N: order by description
 Furukawa Electric America, Inc.
 200 Westpark Drive
 Suite 190
 Peachtree City, GA 30269
 (770) 487-1234
 (770) 487-9910 FAX

P/N: order by description
 The Furukawa Electric Co., Ltd
 6-1, Marunouchi 2-chome,
 Chiyoda-ku, Tokyo 100, Japan
 81-3-3286-3226
 81-3-3286-3747 FAX

PI-2228-082498

Figure 19. Construction details of transformer TRD8.

MARGIN WOUND TRANSFORMER

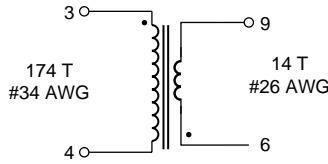

PIN	FUNCTION
3	HIGH-VOLTAGE DC BUS
4	<i>TinySwitch</i> DRAIN
6	RETURN
9	OUTPUT

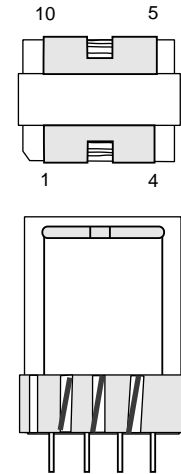

CORE# - PC40 EE16/24/5-Z (TDK)
 GAP FOR A_L OF 182 nH/T²
 BOBBIN# - YC1605 (Ying Chin Co., Ltd.)

ELECTRICAL SPECIFICATIONS		
Electrical Strength	60 Hz, 1 minute, from pins 1-4 to pins 5-10	3000 VAC
Creepage	Between pins 1-4 and pins 5-10	6.0 mm (min)
Primary Inductance	All windings open	3400 μ H \pm 10%
Resonant Frequency	All windings open	420 kHz (min)
Primary Leakage Inductance	Pins 6 and 9 shorted	120 μ H (max)

NOTE: All inductance measurements should be made at 40 kHz

PI-2222-082198

Figure 20. Electrical specification of transformer TRD8-1.



MARGIN WOUND TRANSFORMER CONSTRUCTION

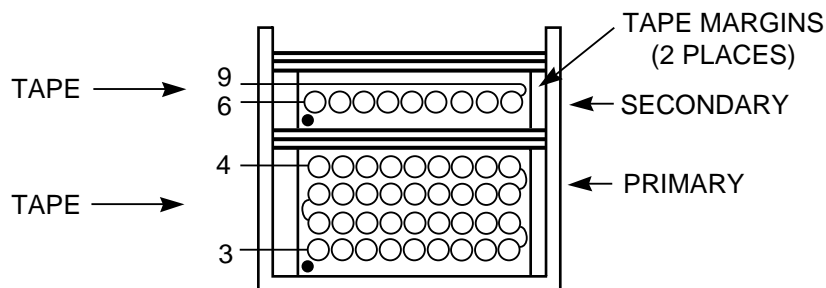

WINDING INSTRUCTIONS

Primary	Start at Pin 3. Wind 174 turns of 34 AWG heavy nyleze wire in four layers. Finish on Pin 4.
Reinforced Insulation	Apply 3 layers of tape (polyester film, 17.5 mm (0.689 in) wide and 0.056 mm (2.2 mil) thick) for reinforced insulation.
Safety Margin	Construct margins on each side of bobbin using 3 mm wide tape on flange side of bobbin and 6 mm wide tape on pin side of bobbin. Match height of secondary winding.
Secondary Winding	Start at Pin 6. Wind 14 turns of 26 AWG heavy nyleze wire from left to right in a single layer. Finish on Pin 9.
Outer Insulation	Apply 3 layers of 17.5 mm tape for outer insulation.
Final Assembly	Assemble and secure core halves. Glue according to Power Integrations instructions (see Power Integrations website: www.powerint.com).

PI-2224-082498

Figure 21. Construction details of transformer TRD8-1.

For the latest updates, visit our website: www.powerint.com

Power Integrations reserves the right to make changes to its products at any time to improve reliability or manufacturability. Power Integrations does not assume any liability arising from the use of any device or circuit described herein, nor does it convey any license under its patent rights or the rights of others.

PI Logo and *TOPSwitch* are registered trademarks of Power Integrations, Inc.
©Copyright 1999, Power Integrations, Inc. 477 N. Mathilda Avenue, Sunnyvale, CA 94086

WORLD HEADQUARTERS

NORTH AMERICA - WEST

Power Integrations, Inc.
477 N. Mathilda Avenue
Sunnyvale, CA 94086 USA
Main: +1•408•523•9200
Customer Service:
Phone: +1•408•523•9265
Fax: +1•408•523•9365

NORTH AMERICA - EAST & SOUTH AMERICA

Power Integrations, Inc.
Eastern Area Sales Office
1343 Canton Road, Suite C1
Marietta, GA 30066 USA
Phone: +1•770•424•5152
Fax: +1•770•424•6567

EUROPE & AFRICA

Power Integrations (Europe) Ltd.
Centennial Court
Easthampstead Road
Bracknell
Berkshire RG12 1YQ,
United Kingdom
Phone: +44•1753•622•208
Fax: +44•1753•622•209

TAIWAN

Power Integrations International
Holdings, Inc.
2F, #508, Chung Hsiao E. Rd., Sec. 5,
Taipei 105, Taiwan
Phone: +886•2•2727•1221
Fax: +886•2•2727•1223

KOREA

Power Integrations International
Holdings, Inc.
Rm# 402, Handuk Building,
649-4 Yeoksam-Dong, Kangnam-Gu,
Seoul, Korea
Phone: +82•2•568•7520
Fax: +82•2•568•7474

JAPAN

Power Integrations, K.K.
Keihin-Tatemono 1st Bldg.
12-20 Shin-Yokohama 2-Chome,
Kohoku-ku, Yokohama-shi,
Kanagawa 222, Japan
Phone: +81•45•471•1021
Fax: +81•45•471•3717

INDIA (Technical Support)

Innovatech
#1, 8th Main Road
Vasanthnagar
Bangalore 560052, India
Phone: +91•80•226•6023
Fax: +91•80•228•2191

APPLICATIONS HOTLINE

World Wide +1•408•523•9260

APPLICATIONS FAX

World Wide +1•408•523•9361

