



 SUMITOMO ELECTRIC

**Preliminary**

03.05.26

**P0511946H**

1.9 GHz band

**Power Amplifier Module**

#### ◆ **Features**

- 1.9 GHz frequency band
- Typical 39.0 dBm output power
- Low power consumption 43 W typ.
- Excellent adjacent leakage power
- Typical 30 dB power gain
- Cost-effective metal package
- Low thermal resistance structure

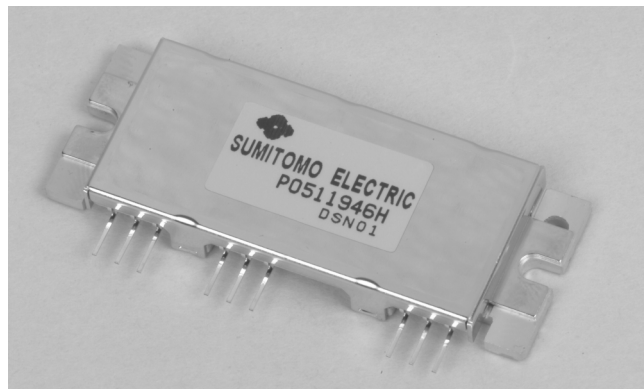

#### ◆ **Applications**

- Final stage power amplifier of base station for PHS

#### ◆ **Description**

The P0511946H is a high performance 1.9 GHz band power amplifier module capable of 39 dBm output power with a typical 30 dB gain at 1.9 GHz band, housed in a cost effective metal package. This device features a low power consumption owing to the excellent linearity and high gain of the pulse-doped GaAs MESFET developed by SEI, dissipating 3600 mA typical. It operates from +12 V and -5 V power supplies.

◆ **Absolute Maximum Ratings**Case Temperature T<sub>c</sub>=35 °C

Parameter	Symbol	Value	Units
DC Supply Voltage	V <sub>d</sub>	13* <sup>1</sup>	V
	V <sub>g</sub>	- 6	V
Input Power	P <sub>in</sub>	15	dBm
Storage Temperature	T <sub>stg</sub>	-40 to + 90	°C
Operating Case Temperature	T <sub>opt</sub>	-20 to + 85* <sup>2</sup>	°C

Notes: Operating of this device above any one of these parameters may cause permanent damage.

\*1:V<sub>g1</sub>,V<sub>g2</sub>=-5.0 V

\*2:Burst Operation (Duty Ratio&lt;=50%)

◆ **Electrical Specifications**Case Temperature T<sub>c</sub>=35°C

Parameter	Symbol	Test Conditions	Value			Units
			Min.	Typ.	Max.	
Frequency	f		1880	—	1920	MHz
Supply Current (under operation)	I <sub>D</sub>	P <sub>out</sub> =39.0 dBm V <sub>d1</sub> =12V V <sub>d2</sub> =12 V V <sub>d3</sub> =12V V <sub>g1</sub> =-5.0 V V <sub>g2</sub> =-5.0 V	—	3600	4000	mA
Gate Current	I <sub>G</sub>		—	—	20	mA
Power Gain	G <sub>a</sub>		27.0	30.0	—	dB
Input VSWR	—		—	1.8	2.5	—
Harmonic Distortion	2f <sub>0</sub>		—	—	-40	dBc
	3f <sub>0</sub>		—	—	-40	dBc
Adjacent Channel Leakage Power Ratio	ACLR1	600 kHz offset	—	—	-68	dBc
	ACLR2	900 kHz offset	—	—	-74	dBc
Occupied Frequency Bandwidth	—	—	—	—	270	kHz

◆ Power Characteristics

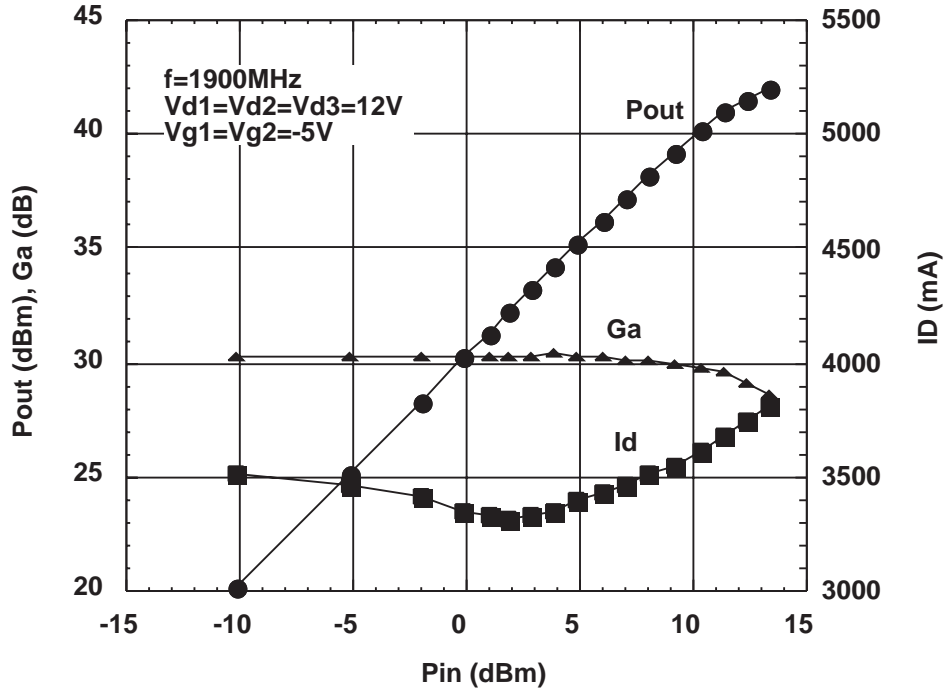

◆ Adjacent Channel Leakage Power Ratio

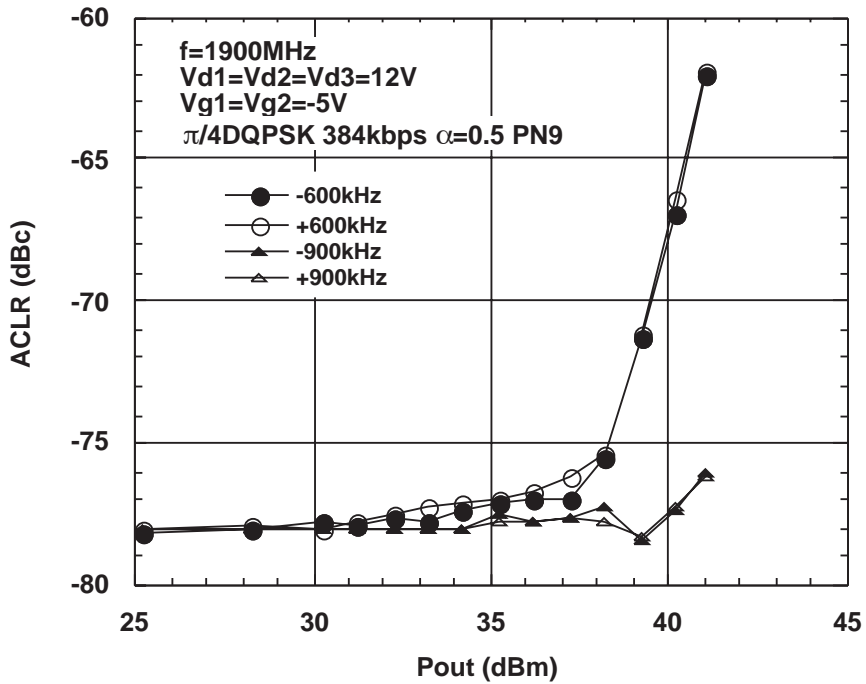

◆ Package Drawings (Dimensions are mm)

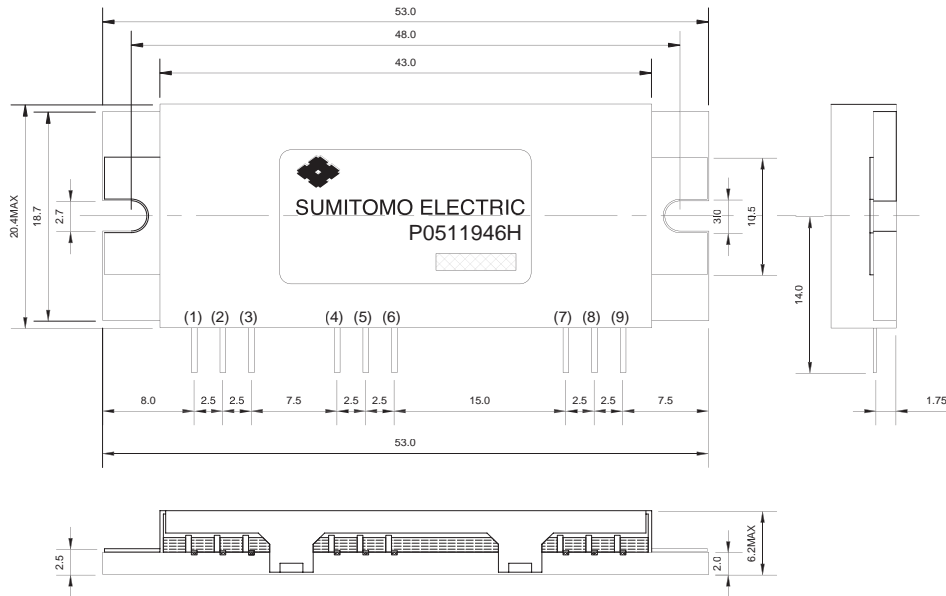

 lot no.  
 Dimensions are mm (+/- 0.3mm)  
 Lead Size : 0.25x0.5

Note: (1)Lead Size : 0.25x0.5  
 (2)Nominal Variation of Lead Pitch : ±0.3  
 (3)Nominal Variation of parts undescribed : ±0.3

◆ Pin Assignment

(1) RFin	(2) GND	(3) Vd1	(4) Vg1
(5) Vd2	(6) Vg2	(7) Vd3	(8) GND
(9) RFout	Case:GND		

◆ Evaluation Board Layout (Dimensions are mm)

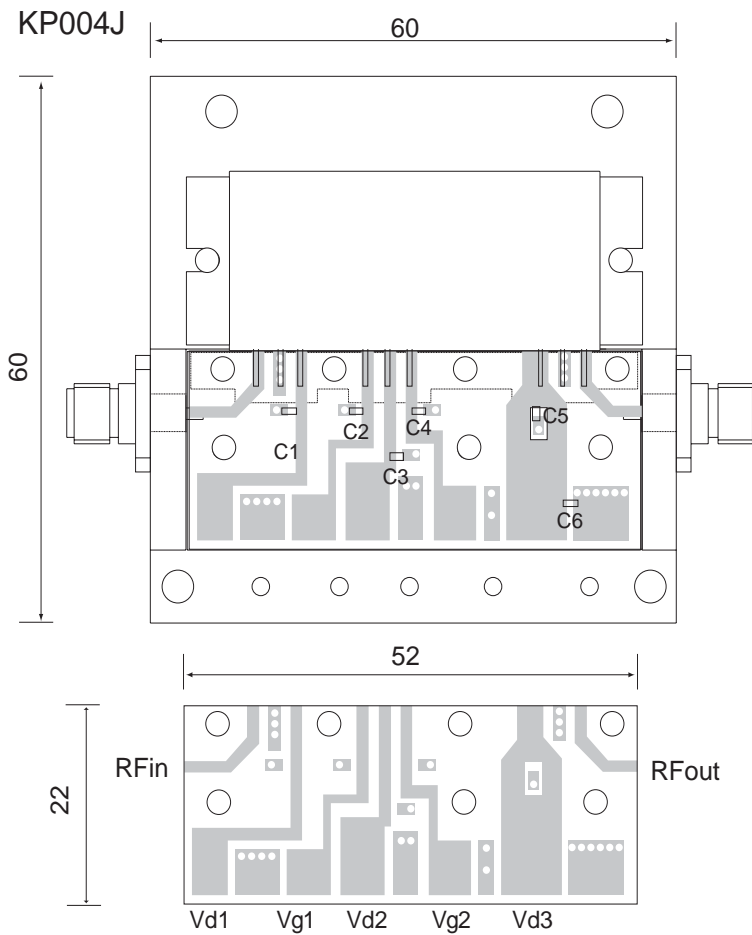

Circuit Board  
 0.8mm Dielectric Thickness  
 $r=4.0, 18\mu\text{m}$  copper

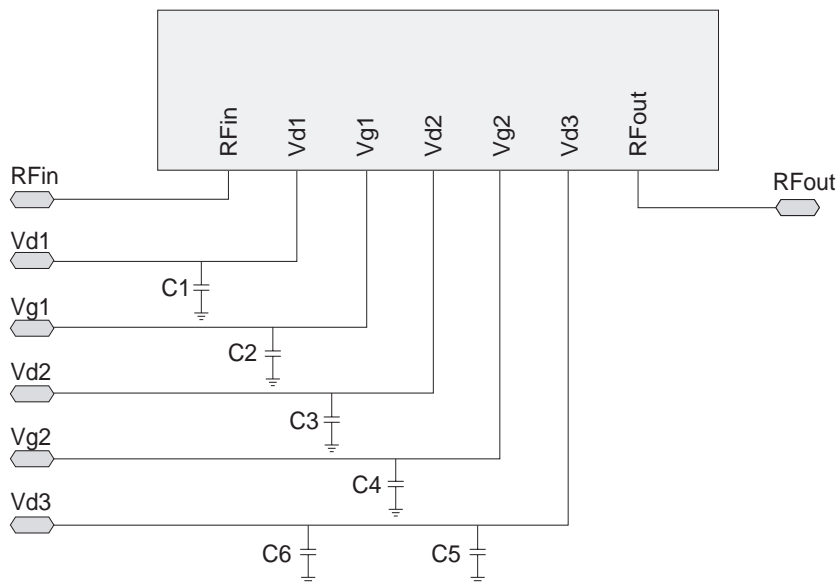

DESIGNATION	VALUE
C2,C4	0.1 $\mu\text{F}$
C1,C3,C5,C6	1.0 $\mu\text{F}$