

FEATURES

- **HIGH GAIN BANDWIDTH:**
f_T = 20 GHz
- **HIGH OUTPUT POWER:**
P_{-1dB} = 26 dBm at 1.8 GHz
- **HIGH LINEAR GAIN:**
G_L = 12 dB at 1.8 GHz
- **LOW PROFILE M04 PACKAGE:**
SOT-343 footprint, with a height of only 0.59 mm
Flat lead style for better RF performance

DESCRIPTION

NEC's NE664M04 is fabricated using NEC's state-of-the-art UHS0 25 GHz f_T wafer process. With a transition frequency of 20 GHz, the NE664M04 is usable in applications from 100 MHz to over 3 GHz. The NE664M04 provides P_{1dB} of 26 dBm, even with low voltage and low current, making this device an excellent choice for the output or driver stage for mobile or fixed wireless applications.

The NE664M04 is housed in NEC's low profile/flat lead style "M04" package

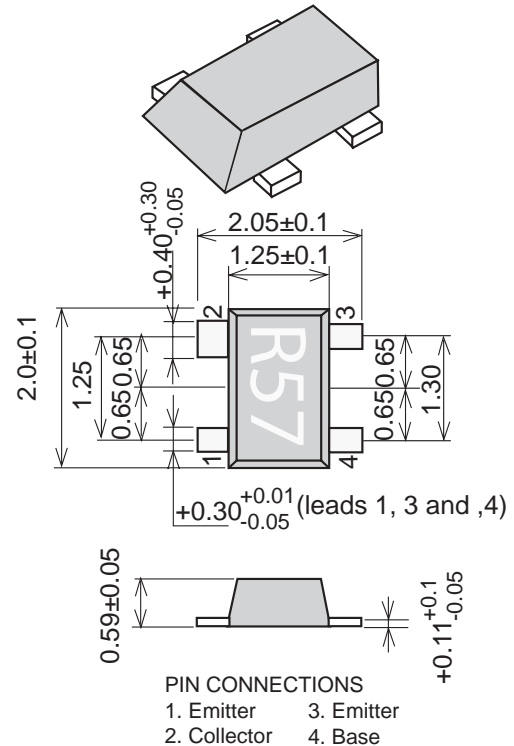

ELECTRICAL CHARACTERISTICS (T_A = 25°C)

| PART NUMBER PACKAGE OUTLINE EIAJ ³ REGISTRATION NUMBER | | | NE664M04 M04 2SC5754 | | | |
|---|---------------------------------|---|----------------------------|-----|------|------|
| | SYMBOLS | PARAMETERS AND CONDITIONS | UNITS | MIN | TYP | MAX |
| DC | I _{CBO} | Collector Cutoff Current at V _{CB} = 5V, I _E = 0 | nA | | | 1000 |
| | I _{EBO} | Emitter Cutoff Current at V _{EB} = 1V, I _C = 0 | nA | | | 1000 |
| | h _{FE} | DC Current ¹ Gain at V _{CE} = 3V, I _C = 100 mA | | 40 | 60 | 100 |
| RF | P _{1dB} | Output Power at 1 dB compression point at V _{CE} = 3.6V, I _{CQ} = 4 mA, f = 1.8 GHz, P _{in} = 15 dBm, 1/2 Duty Cycle | dBm | | 26.0 | |
| | G _L | Linear Gain at V _{CE} = 3.6V, I _{CQ} = 20 mA, f = 1.8 GHz, P _{in} = 0 dBm, 1/2 Duty Cycle | dB | | 12.0 | |
| | MAG | Maximum Available Power Gain ⁴ at V _{CE} = 3V, I _C = 100 mA, f = 2 GHz | dBm | | 12.0 | |
| | S _{21E} ² | Insertion Power Gain at V _{CE} = 3V, I _C = 100 mA, f = 2 GHz | dB | 5.0 | 6.5 | |
| | η _c | Collector Efficiency, 3.6V, I _{CQ} = 4 mA, f = 1.8 GHz, P _{in} = 15 dBm, 1/2 Duty Cycle | % | | 60 | |
| | f _T | Gain Bandwidth at V _{CE} = 3V, I _C = 100 mA, f = 0.5 GHz | GHz | 16 | 20 | |
| | C _{re} | Feedback Capacitance ² at V _{CB} = 3V, I _C = 0, f = 1 MHz | pF | | 1.0 | 1.5 |

Notes:

1. Pulsed measurement, pulse width ≤ 350 μs, duty cycle ≤ 2 %.
2. Collector to Base capacitance measured by capacitance meter(automatic balance bridge method) when emitter pin is connected to the guard pin of capacitance meter.
3. Electronic Industriail Association of Japan

$$4. \text{MAG} = \frac{|S_{21}|}{|S_{12}|} \left(K - \sqrt{K^2 - 1} \right).$$

NE664M04

ABSOLUTE MAXIMUM RATINGS¹ (T_A = 25°C)

| SYMBOLS | PARAMETERS | UNITS | RATINGS |
|------------------|--------------------------------------|-------|-------------|
| V _{CB0} | Collector to Base Voltage | V | 13 |
| V _{CE0} | Collector to Emitter Voltage | V | 5.0 |
| V _{EB0} | Emitter to Base Voltage | V | 1.5 |
| I _C | Collector Current | mA | 500 |
| P _T | Total Power Dissipation ² | mW | 735 |
| T _J | Junction Temperature | °C | 150 |
| T _{STG} | Storage Temperature | °C | -65 to +150 |

Note:

1. Operation in excess of any one of these parameters may result in permanent damage.
2. Mounted on 38 x 38 mm, t = 0.4 mm polyimide PCB.

ORDERING INFORMATION

| PART NUMBER | QUANTITY |
|-------------|--------------|
| NE664M04-T2 | 3k pcs./reel |

THERMAL RESISTANCE

| SYMBOLS | PARAMETERS | UNITS | RATINGS |
|----------------------|---|-------|---------|
| R _{th j-a1} | Junction to Ambient Resistance ¹ | °C/W | 170 |
| R _{th j-a2} | Junction to Ambient Resistance ² | °C/W | 570 |

Note:

1. Mounted on 38 x 38 mm, t = 0.4 mm polyimide PCB.
2. Stand alone device in free air.

APPLICATIONS

Bluetooth Power Class 1
f = 2.4 GHz

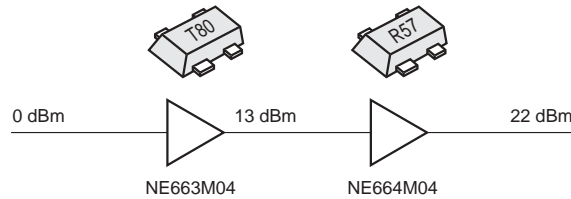

SS Cordless Phone
f = 2.4 GHz

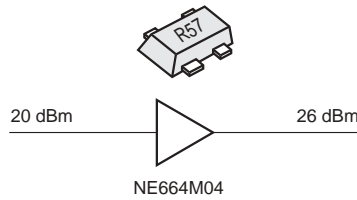

DCS1800 (GSM1800) Cellular Phone
f = 1.8 GHz

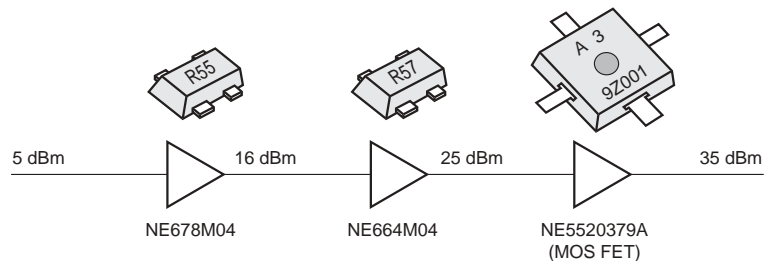

Cordless Phone
f = 0.9 GHz

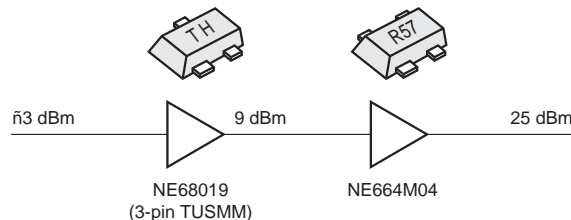

TYPICAL PERFORMANCE CURVES ($T_A = 25^\circ\text{C}$)

TOTAL POWER DISSIPATION vs. AMBIENT TEMPERATURE

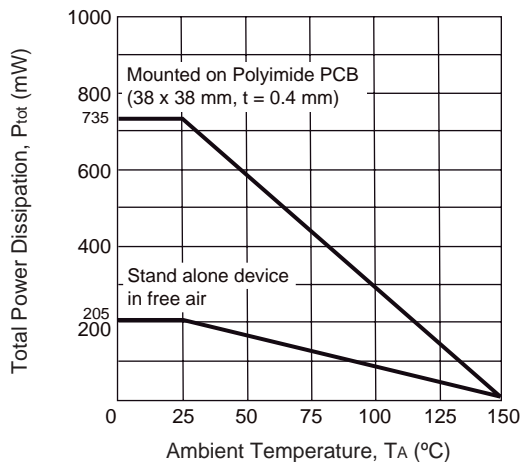

REVERSE TRANSFER CAPACITANCE vs. COLLECTOR TO BASE VOLTAGE

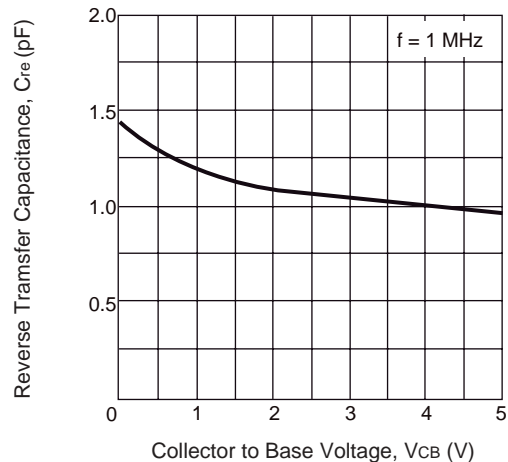

COLLECTOR CURRENT vs. BASE TO EMITTER VOLTAGE

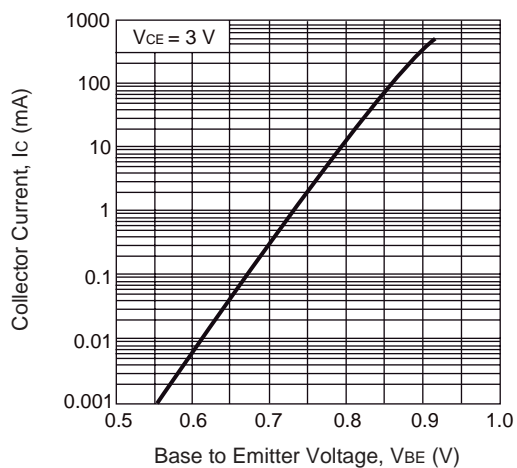

COLLECTOR CURRENT vs. COLLECTOR TO EMITTER VOLTAGE

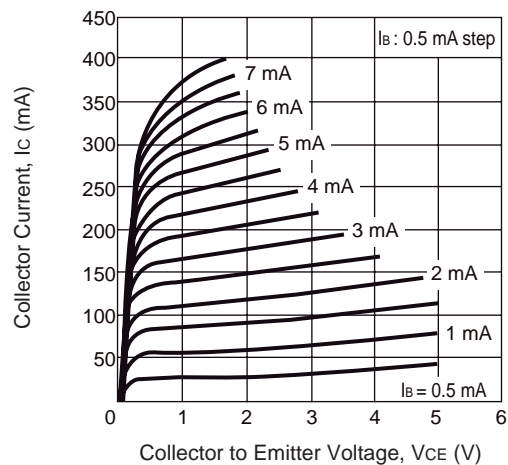

DC CURRENT GAIN vs. COLLECTOR CURRENT

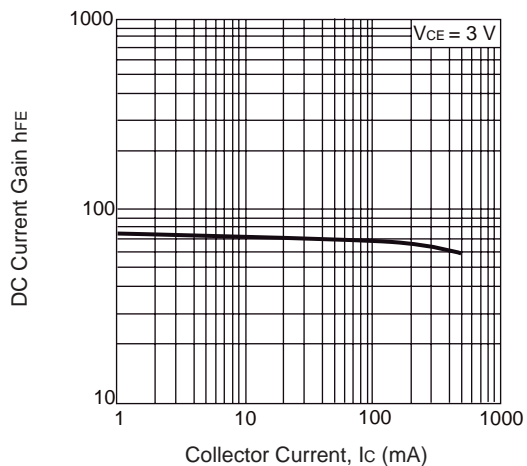

TYPICAL PERFORMANCE CURVES (T_A = 25°C)

GAIN BANDWIDTH PRODUCT vs. COLLECTOR CURRENT

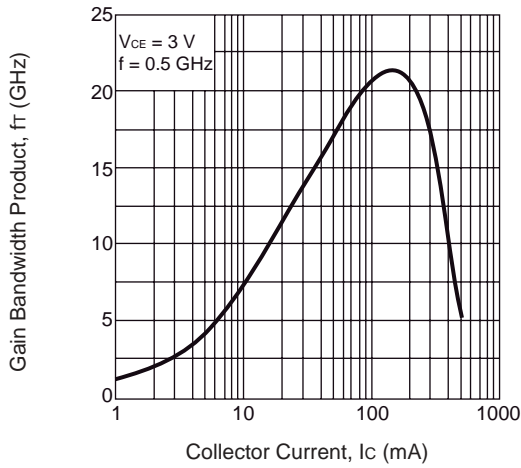

INSERTION POWER GAIN, MAG, MSG vs. FREQUENCY

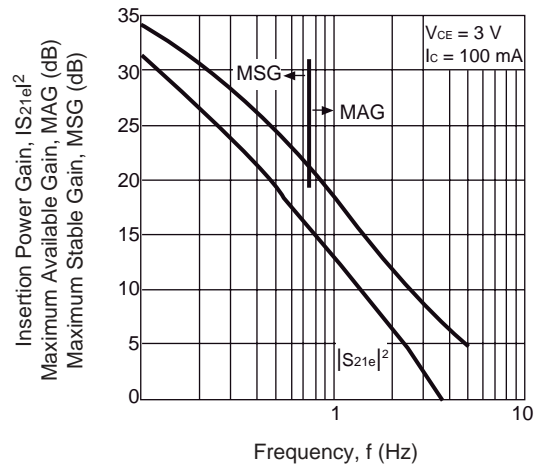

INSERTION POWER GAIN, MAG, MSG vs. COLLECTOR CURRENT

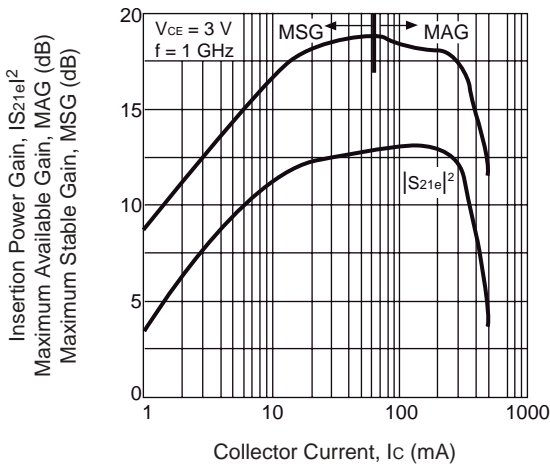

INSERTION POWER GAIN, MAG, MSG vs. COLLECTOR CURRENT

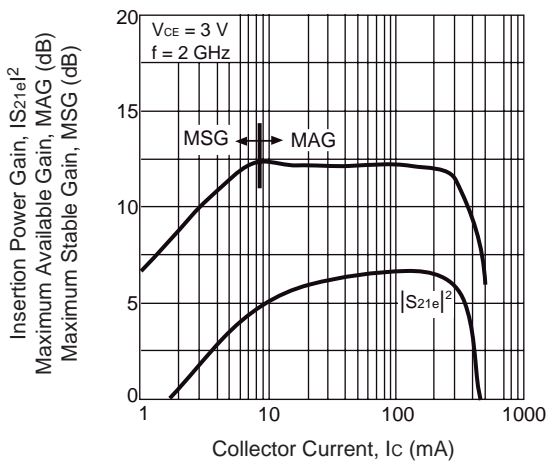

INSERTION POWER GAIN, MAG, MSG vs. COLLECTOR CURRENT

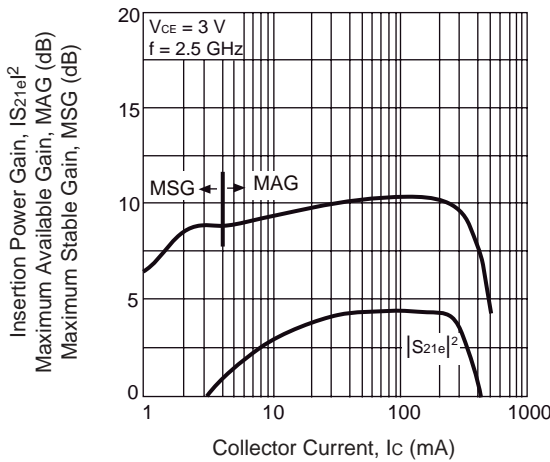

TYPICAL PERFORMANCE CURVES ($T_A = 25^\circ\text{C}$)

OUTPUT POWER, POWER GAIN, COLLECTOR CURRENT, & COLLECTOR EFFICIENCY vs. INPUT POWER

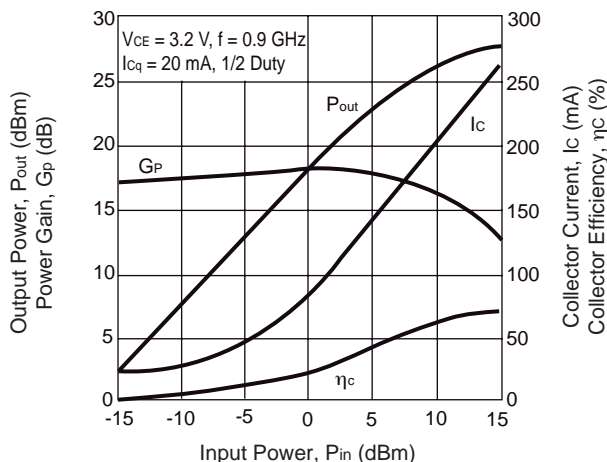

OUTPUT POWER, POWER GAIN, COLLECTOR CURRENT, & COLLECTOR EFFICIENCY vs. INPUT POWER

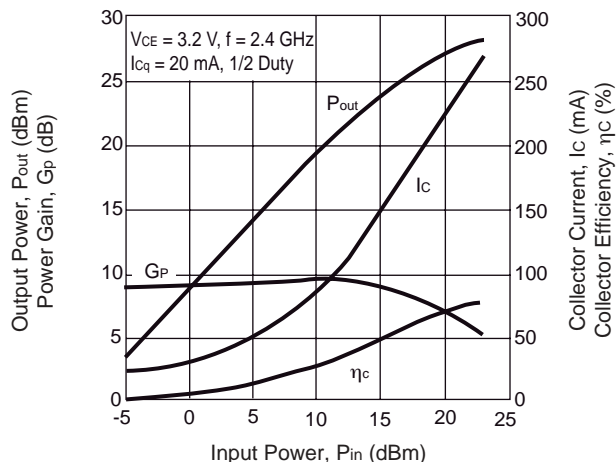

OUTPUT POWER, POWER GAIN, COLLECTOR CURRENT, & COLLECTOR EFFICIENCY vs. INPUT POWER

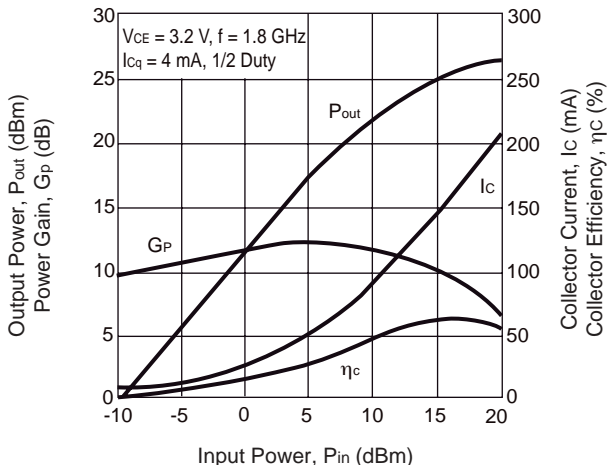

OUTPUT POWER, POWER GAIN, COLLECTOR CURRENT, & COLLECTOR EFFICIENCY vs. INPUT POWER

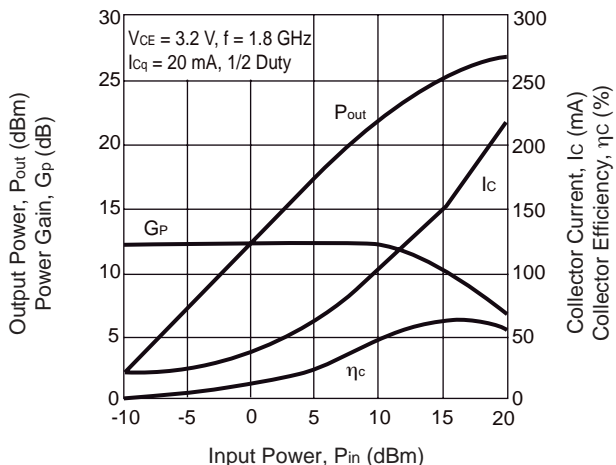

OUTPUT POWER, POWER GAIN, COLLECTOR CURRENT, & COLLECTOR EFFICIENCY vs. INPUT POWER

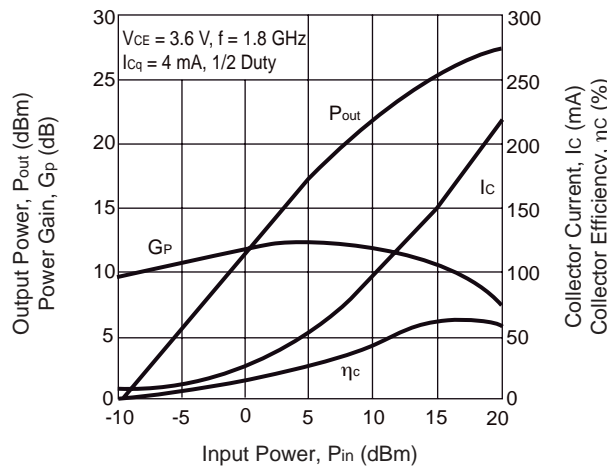

OUTPUT POWER, POWER GAIN, COLLECTOR CURRENT, & COLLECTOR EFFICIENCY vs. INPUT POWER

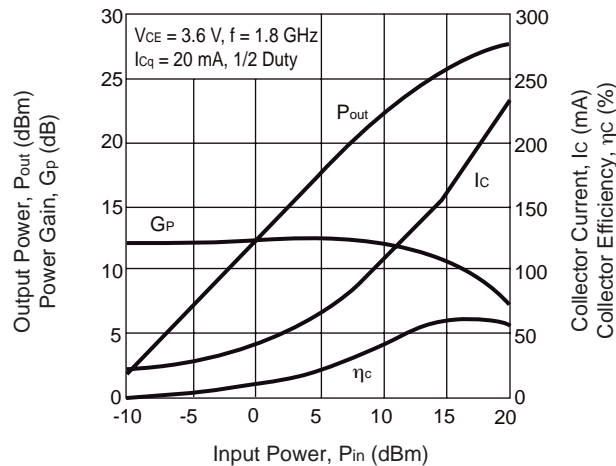

LARGE SIGNAL IMPEDANCES

| FREQUENCY f (GHz) | COLLECTOR TO EMITTER VOLTAGE V_{CE} (V) | SOURCE IMPEDANCE Z_s (Ω) | LOAD IMPEDANCE Z_L (Ω) |
|----------------------|--|--|--------------------------------------|
| 0.9 | 2.8 to 3.6 | 8.4 - 5.2j | 15.1- 4.3j |
| 1.8 | 2.8 to 3.6 | 6.3 - 16.4j | 15.8- 6.9j |
| 2.4 | 2.8 to 3.6 | 5.9 - 22.1j | 15.2- 17.9j |

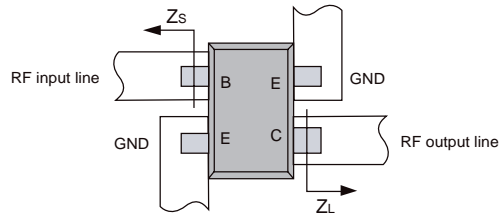
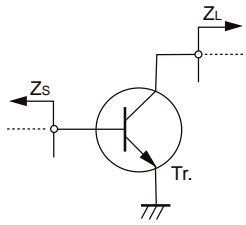

f = 0.9 GHz

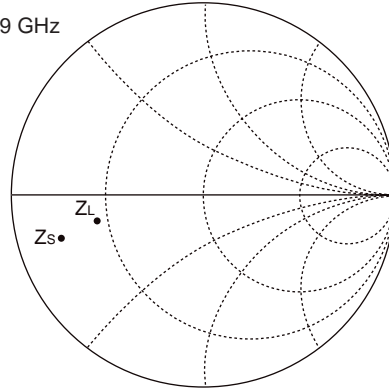

f = 1.8 GHz

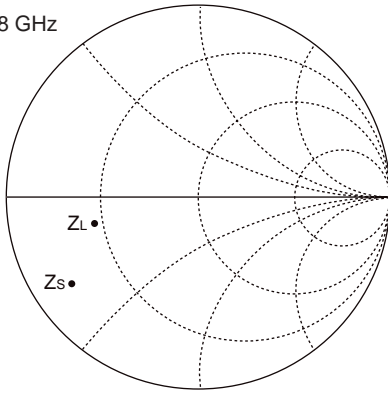

f = 2.4 GHz

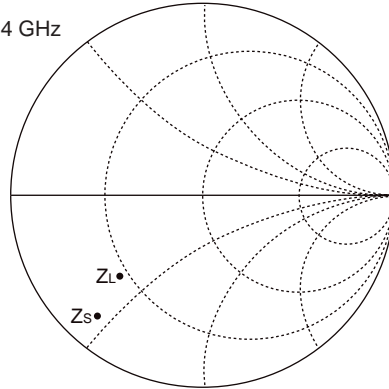

TYPICAL SCATTERING PARAMETERS (T_A = 25°C)

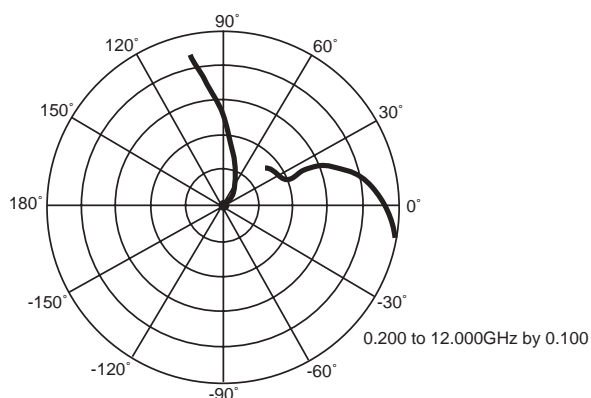
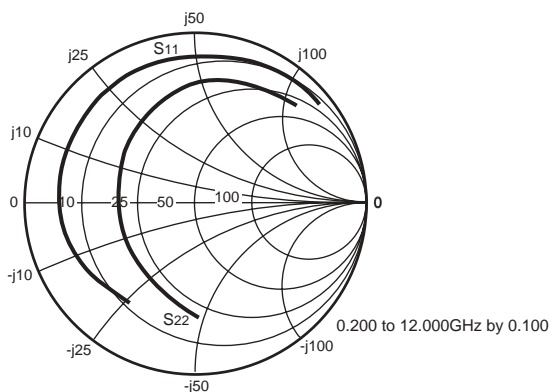

NE664M04

V_c = 1 V, I_c = 10 mA

| FREQUENCY GHz | S ₁₁ | | S ₂₁ | | S ₁₂ | | S ₂₂ | | K | MAG ¹ (dB) |
|------------------|-----------------|--------|-----------------|--------|-----------------|--------|-----------------|--------|------|--------------------------|
| | MAG | ANG | MAG | ANG | MAG | ANG | MAG | ANG | | |
| 0.50 | 0.784 | -161.6 | 6.573 | 95.1 | 0.075 | 19.0 | 0.491 | -138.6 | 0.32 | 19.44 |
| 1.00 | 0.801 | 178.1 | 3.389 | 77.6 | 0.081 | 16.3 | 0.454 | -164.9 | 0.60 | 16.23 |
| 1.50 | 0.810 | 166.2 | 2.271 | 65.1 | 0.084 | 18.9 | 0.460 | -178.3 | 0.85 | 14.33 |
| 2.00 | 0.812 | 157.2 | 1.710 | 54.4 | 0.090 | 18.1 | 0.467 | 172.5 | 1.03 | 11.77 |
| 2.50 | 0.820 | 149.0 | 1.378 | 44.3 | 0.097 | 20.8 | 0.476 | 165.3 | 1.16 | 9.14 |
| 3.00 | 0.827 | 141.5 | 1.163 | 35.2 | 0.109 | 20.6 | 0.482 | 158.0 | 1.20 | 7.60 |
| 3.50 | 0.834 | 133.6 | 1.013 | 26.1 | 0.119 | 18.7 | 0.498 | 151.0 | 1.22 | 6.47 |
| 4.00 | 0.838 | 125.9 | 0.901 | 17.1 | 0.133 | 16.2 | 0.508 | 143.9 | 1.22 | 5.49 |
| 4.50 | 0.845 | 118.0 | 0.816 | 8.6 | 0.146 | 11.6 | 0.525 | 136.4 | 1.19 | 4.84 |
| 5.00 | 0.850 | 110.4 | 0.743 | 0.1 | 0.160 | 8.6 | 0.546 | 128.9 | 1.17 | 4.15 |
| 5.50 | 0.855 | 102.3 | 0.678 | - 7.5 | 0.170 | 5.7 | 0.570 | 121.9 | 1.19 | 3.40 |
| 6.00 | 0.861 | 95.2 | 0.624 | - 14.9 | 0.175 | 0.9 | 0.599 | 115.4 | 1.18 | 2.93 |
| 6.50 | 0.866 | 88.6 | 0.573 | - 21.9 | 0.190 | - 3.9 | 0.625 | 108.6 | 1.15 | 2.44 |
| 7.00 | 0.874 | 82.3 | 0.530 | - 28.0 | 0.195 | - 7.7 | 0.650 | 102.4 | 1.14 | 2.05 |
| 7.50 | 0.881 | 76.5 | 0.485 | - 34.0 | 0.198 | - 12.6 | 0.676 | 95.6 | 1.14 | 1.58 |
| 8.00 | 0.889 | 72.0 | 0.451 | - 38.9 | 0.203 | - 17.2 | 0.696 | 89.6 | 1.13 | 1.29 |
| 8.50 | 0.898 | 67.3 | 0.422 | - 44.1 | 0.211 | - 21.6 | 0.716 | 83.0 | 1.09 | 1.14 |
| 9.00 | 0.905 | 63.5 | 0.391 | - 48.5 | 0.205 | - 25.6 | 0.733 | 76.4 | 1.11 | 0.76 |
| 9.50 | 0.911 | 60.2 | 0.360 | - 52.4 | 0.208 | - 30.2 | 0.740 | 70.9 | 1.11 | 0.34 |
| 10.00 | 0.916 | 56.1 | 0.337 | - 56.3 | 0.208 | - 33.9 | 0.768 | 63.4 | 1.12 | 0.01 |
| 10.50 | 0.917 | 52.2 | 0.321 | - 60.0 | 0.209 | - 38.7 | 0.782 | 58.1 | 1.12 | - 0.24 |
| 11.00 | 0.926 | 48.4 | 0.305 | - 64.1 | 0.210 | - 42.2 | 0.793 | 53.2 | 1.09 | - 0.27 |
| 11.50 | 0.923 | 44.4 | 0.295 | - 66.4 | 0.208 | - 46.5 | 0.811 | 49.2 | 1.11 | - 0.52 |
| 12.00 | 0.931 | 40.0 | 0.290 | - 69.9 | 0.221 | - 50.7 | 0.816 | 46.3 | 1.06 | - 0.27 |

Note:

1. Gain Calculations:

$$MAG = \frac{|S_{21}|}{|S_{12}|} \left(K \pm \sqrt{K^2 - 1} \right). \text{ When } K \leq 1, \text{ MAG is undefined and MSG values are used. } MSG = \frac{|S_{21}|}{|S_{12}|}, K = \frac{1 + |\Delta|^2 - |S_{11}|^2 - |S_{22}|^2}{2 |S_{12} S_{21}|}, \Delta = S_{11} S_{22} - S_{21} S_{12}$$

MAG = Maximum Available Gain

MSG = Maximum Stable Gain

TYPICAL SCATTERING PARAMETERS (T_A = 25°C)

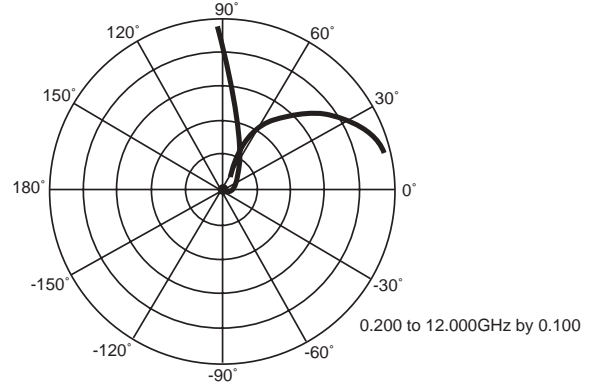
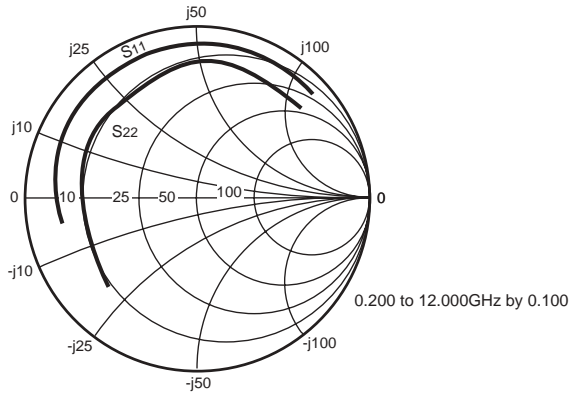

NE664M04

V_c = 2 V, I_c = 100 mA

| FREQUENCY | S ₁₁ | | S ₂₁ | | S ₁₂ | | S ₂₂ | | K | MAG ¹ |
|-----------|-----------------|-------|-----------------|--------|-----------------|--------|-----------------|--------|------|------------------|
| GHz | MAG | ANG | MAG | ANG | MAG | ANG | MAG | ANG | | (dB) |
| 0.50 | 0.808 | 177.3 | 9.415 | 90.1 | 0.027 | 50.0 | 0.652 | -167.8 | 0.87 | 25.50 |
| 1.00 | 0.812 | 167.0 | 4.762 | 77.9 | 0.046 | 62.1 | 0.650 | 176.3 | 1.04 | 18.88 |
| 1.50 | 0.819 | 158.7 | 3.176 | 68.6 | 0.065 | 57.6 | 0.657 | 166.5 | 1.07 | 15.33 |
| 2.00 | 0.822 | 151.3 | 2.387 | 60.0 | 0.083 | 53.6 | 0.662 | 158.5 | 1.08 | 12.85 |
| 2.50 | 0.830 | 143.8 | 1.925 | 51.6 | 0.106 | 48.0 | 0.666 | 151.4 | 1.06 | 11.12 |
| 3.00 | 0.831 | 137.2 | 1.616 | 43.8 | 0.123 | 43.3 | 0.670 | 144.1 | 1.07 | 9.60 |
| 3.50 | 0.834 | 129.9 | 1.410 | 36.0 | 0.140 | 37.1 | 0.669 | 137.0 | 1.07 | 8.45 |
| 4.00 | 0.837 | 122.8 | 1.256 | 27.7 | 0.159 | 30.9 | 0.672 | 129.3 | 1.06 | 7.52 |
| 4.50 | 0.836 | 115.1 | 1.138 | 19.7 | 0.175 | 25.2 | 0.680 | 121.7 | 1.06 | 6.61 |
| 5.00 | 0.843 | 107.7 | 1.035 | 12.1 | 0.188 | 18.1 | 0.691 | 114.7 | 1.06 | 5.96 |
| 5.50 | 0.843 | 100.1 | 0.945 | 4.4 | 0.197 | 11.6 | 0.701 | 108.2 | 1.06 | 5.25 |
| 6.00 | 0.851 | 93.1 | 0.868 | - 2.5 | 0.207 | 6.4 | 0.715 | 101.9 | 1.06 | 4.71 |
| 6.50 | 0.857 | 86.5 | 0.800 | - 9.0 | 0.212 | - 0.2 | 0.731 | 95.8 | 1.06 | 4.23 |
| 7.00 | 0.865 | 80.8 | 0.742 | - 15.3 | 0.222 | - 4.7 | 0.745 | 90.2 | 1.06 | 3.80 |
| 7.50 | 0.866 | 75.4 | 0.688 | - 21.2 | 0.225 | - 10.8 | 0.751 | 84.5 | 1.07 | 3.29 |
| 8.00 | 0.874 | 70.6 | 0.641 | - 26.6 | 0.225 | - 15.7 | 0.761 | 78.7 | 1.07 | 2.94 |
| 8.50 | 0.883 | 66.5 | 0.591 | - 32.4 | 0.227 | - 19.8 | 0.772 | 72.4 | 1.07 | 2.56 |
| 9.00 | 0.891 | 62.6 | 0.551 | - 37.1 | 0.231 | - 25.9 | 0.774 | 66.3 | 1.06 | 2.24 |
| 9.50 | 0.900 | 59.2 | 0.517 | - 43.0 | 0.221 | - 30.6 | 0.788 | 60.8 | 1.06 | 2.17 |
| 10.00 | 0.902 | 55.6 | 0.491 | - 47.2 | 0.226 | - 34.5 | 0.796 | 54.7 | 1.07 | 1.80 |
| 10.50 | 0.914 | 51.8 | 0.456 | - 52.1 | 0.219 | - 39.4 | 0.805 | 49.5 | 1.06 | 1.69 |
| 11.00 | 0.918 | 48.1 | 0.435 | - 56.2 | 0.219 | - 43.8 | 0.810 | 45.5 | 1.05 | 1.54 |
| 11.50 | 0.917 | 44.1 | 0.419 | - 60.1 | 0.219 | - 47.4 | 0.822 | 41.9 | 1.06 | 1.31 |
| 12.00 | 0.917 | 39.7 | 0.413 | - 63.7 | 0.229 | - 50.6 | 0.822 | 38.8 | 1.05 | 1.13 |

Note:

1. Gain Calculations:

$$MAG = \frac{|S_{21}|}{|S_{12}|} \left(K \pm \sqrt{K^2 - 1} \right). \text{ When } K \leq 1, \text{ MAG is undefined and MSG values are used. } MSG = \frac{|S_{21}|}{|S_{12}|}, K = \frac{1 + |\Delta|^2 - |S_{11}|^2 - |S_{22}|^2}{2 |S_{12} S_{21}|}, \Delta = S_{11} S_{22} - S_{21} S_{12}$$

MAG = Maximum Available Gain

MSG = Maximum Stable Gain

TYPICAL SCATTERING PARAMETERS (T_A = 25°C)

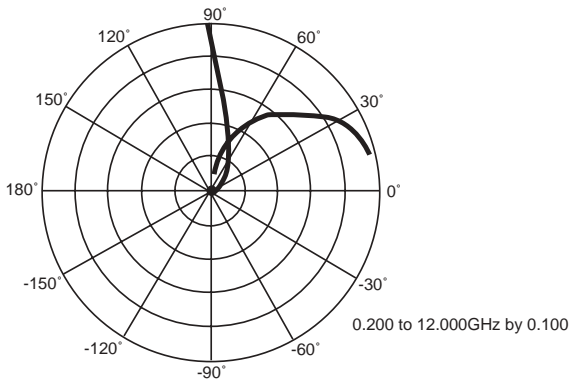
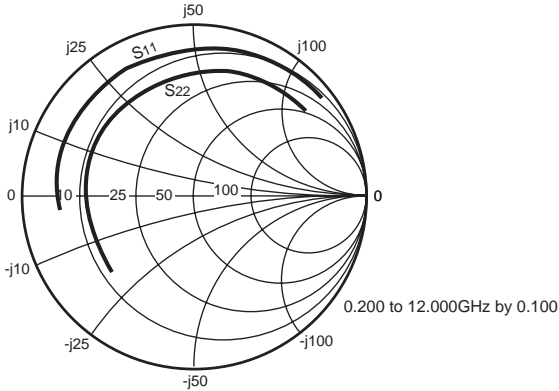

NE664M04
V_c = 3 V, I_c = 200 mA

| FREQUENCY | S ₁₁ | | S ₂₁ | | S ₁₂ | | S ₂₂ | | K | MAG ¹ |
|-----------|-----------------|-------|-----------------|--------|-----------------|--------|-----------------|--------|------|------------------|
| GHz | MAG | ANG | MAG | ANG | MAG | ANG | MAG | ANG | | (dB) |
| 0.50 | 0.801 | 175.9 | 9.856 | 89.7 | 0.024 | 66.8 | 0.624 | -169.4 | 1.01 | 25.43 |
| 1.00 | 0.808 | 166.3 | 4.975 | 77.5 | 0.044 | 68.0 | 0.632 | 175.5 | 1.07 | 18.85 |
| 1.50 | 0.815 | 158.4 | 3.310 | 68.2 | 0.066 | 62.1 | 0.633 | 166.7 | 1.07 | 15.41 |
| 2.00 | 0.819 | 150.9 | 2.483 | 59.8 | 0.084 | 57.6 | 0.638 | 158.1 | 1.08 | 12.95 |
| 2.50 | 0.822 | 143.9 | 1.996 | 51.6 | 0.102 | 52.3 | 0.644 | 150.8 | 1.09 | 11.11 |
| 3.00 | 0.830 | 136.8 | 1.676 | 43.6 | 0.122 | 43.9 | 0.648 | 144.1 | 1.07 | 9.80 |
| 3.50 | 0.832 | 129.7 | 1.461 | 35.8 | 0.138 | 39.2 | 0.653 | 136.7 | 1.07 | 8.62 |
| 4.00 | 0.831 | 122.5 | 1.299 | 27.6 | 0.156 | 32.6 | 0.656 | 129.3 | 1.07 | 7.59 |
| 4.50 | 0.835 | 115.0 | 1.171 | 19.8 | 0.173 | 26.9 | 0.662 | 122.1 | 1.07 | 6.75 |
| 5.00 | 0.837 | 107.6 | 1.069 | 12.0 | 0.187 | 19.5 | 0.672 | 114.9 | 1.06 | 6.05 |
| 5.50 | 0.842 | 100.2 | 0.979 | 4.4 | 0.198 | 11.8 | 0.683 | 108.2 | 1.06 | 5.44 |
| 6.00 | 0.848 | 93.0 | 0.896 | - 2.8 | 0.211 | 7.0 | 0.698 | 102.1 | 1.06 | 4.83 |
| 6.50 | 0.853 | 86.4 | 0.828 | - 9.1 | 0.214 | 1.2 | 0.711 | 96.2 | 1.06 | 4.32 |
| 7.00 | 0.862 | 80.5 | 0.764 | - 15.4 | 0.216 | - 4.7 | 0.724 | 90.6 | 1.06 | 3.92 |
| 7.50 | 0.868 | 75.4 | 0.707 | - 21.5 | 0.226 | - 9.8 | 0.736 | 85.1 | 1.06 | 3.47 |
| 8.00 | 0.873 | 70.4 | 0.660 | - 26.8 | 0.231 | - 15.6 | 0.748 | 78.9 | 1.06 | 3.08 |
| 8.50 | 0.881 | 66.5 | 0.611 | - 32.7 | 0.223 | - 20.4 | 0.750 | 72.7 | 1.07 | 2.72 |
| 9.00 | 0.890 | 62.7 | 0.572 | - 36.9 | 0.226 | - 24.0 | 0.764 | 67.2 | 1.07 | 2.45 |
| 9.50 | 0.895 | 59.3 | 0.532 | - 42.0 | 0.226 | - 30.2 | 0.771 | 61.0 | 1.07 | 2.11 |
| 10.00 | 0.903 | 55.7 | 0.498 | - 47.9 | 0.219 | - 33.8 | 0.779 | 55.0 | 1.07 | 1.91 |
| 10.50 | 0.911 | 52.0 | 0.466 | - 51.7 | 0.224 | - 38.3 | 0.793 | 48.9 | 1.06 | 1.64 |
| 11.00 | 0.915 | 48.3 | 0.445 | - 56.3 | 0.219 | - 43.0 | 0.794 | 45.8 | 1.06 | 1.53 |
| 11.50 | 0.919 | 44.1 | 0.430 | - 60.1 | 0.226 | - 46.2 | 0.810 | 41.6 | 1.05 | 1.40 |
| 12.00 | 0.918 | 39.8 | 0.426 | - 64.6 | 0.229 | - 49.5 | 0.811 | 39.3 | 1.05 | 1.34 |

Note:

1. Gain Calculations:

$$MAG = \frac{|S_{21}|}{|S_{12}|} (K \pm \sqrt{K^2 - 1}). \text{ When } K \leq 1, \text{ MAG is undefined and MSG values are used. } MSG = \frac{|S_{21}|}{|S_{12}|}, K = \frac{1 + |\Delta|^2 - |S_{11}|^2 - |S_{22}|^2}{2 |S_{12} S_{21}|}, \Delta = S_{11} S_{22} - S_{21} S_{12}$$

MAG = Maximum Available Gain

MSG = Maximum Stable Gain

Life Support Applications

These NEC products are not intended for use in life support devices, appliances, or systems where the malfunction of these products can reasonably be expected to result in personal injury. The customers of CEL using or selling these products for use in such applications do so at their own risk and agree to fully indemnify CEL for all damages resulting from such improper use or sale.

CEL California Eastern Laboratories, Your source for NEC RF, Microwave, Optoelectronic, and Fiber Optic Semiconductor Devices.

4590 Patrick Henry Drive • Santa Clara, CA 95054-1817 • (408) 988-3500 • FAX (408) 988-0279 • www.cel.com

DATA SUBJECT TO CHANGE WITHOUT NOTICE

04/04/2003