



MAX2160 Evaluation Kit

General Description

The MAX2160 evaluation kit (EV kit) simplifies the testing and evaluation of the MAX2160 single-segment ISDB-T tuner. The evaluation kit is fully assembled and tested at the factory. Standard 50Ω SMA connectors are included on the EV kit for the inputs and outputs to allow quick and easy evaluation on the test bench.

This document provides a list of equipment required to evaluate the device, a straightforward test procedure to verify functionality, a description of the EV kit circuit, the circuit schematic, a bill of materials (BOM) for the kit, and artwork for each layer of the PC board.

Features

- ◆ Easy Evaluation of the MAX2160
- ◆ 50Ω SMA Connectors
- ◆ All Critical Peripheral Components Included
- ◆ Fully Assembled and Tested
- ◆ PC Control Software (Available at www.maxim-ic.com)

Ordering Information

PART	TEMP RANGE	IC PACKAGE
MAX2160EVKIT	-40°C to +85°C	40 Thin QFN-EP*

*EP = Exposed paddle.

Component List

DESIGNATION	QTY	DESCRIPTION
C1, C14, C15, C20–C24, C34, C35, C36, C38, C39	13	0.01μF ±10% ceramic capacitors (0402) Murata GRM155R71E103K
C2	1	27pF ±5% ceramic capacitor (0402) Murata GRM1555C1H270J
C3, C4, C5, C7–C10, C12, C16, C17, C19	11	100pF ±5% ceramic capacitors (0402) Murata GRM1555C1H101J
C6, C18	2	1000pF ceramic capacitors (0402) Murata GRM155R71H102K
C11	1	0Ω resistor (0402)
C13	0	Not installed
C25, C26	2	1μF ±10% ceramic capacitors (0402) Murata GRM155R60J105K
C27	1	0.1μF ±10% ceramic capacitor (0402) Murata GRM155R71C104K
C28	1	0.047μF ceramic capacitor (0402) Murata GRM155R71A473K
C29	1	470pF ±5% ceramic capacitor (0402) Murata GRM1555C1H471J
C30	1	220pF ±5% ceramic capacitor (0402) Murata GRM1555C1H221J
C31, C32, C33	3	10μF ±10% tantalum capacitors (C case) AVX TAJC106K016
C37	1	470nF ±10% ceramic capacitor (0402) Murata GRM155R60J474K
J1, J2, J3, J5, J8, J9	6	Edge-mount SMA connectors—round contacts Johnson 142-0701-801

DESIGNATION	QTY	DESCRIPTION
J4	1	DB25 connector—right-angle male AMP 747238-4
J6	0	2-pin in-line header—0.100in centers Sullins PTC36SAAN
J7	1	2-pin in-line header—0.100in centers Sullins PTC36SAAN
J7, J27	2	Shorting jumpers Sullins STC02SYAN
J10	0	Scope probe Tektronix 131-4244-00 (not installed)
J11, J12	2	PC-mount SMA connectors Johnson 142-0701-201
J13–J17, TP1–TP4	9	Mini red test points Keystone 5000
J18–J26	0	2-pin in-line headers—0.100in centers Sullins PTC36SAAN (not installed)
J27	1	3-pin in-line header—0.100in centers Sullins PTC36SAAN
L1	0	10nH ±5% inductor (0402) Murata LQG15HN10NJ00 (not installed)
R1, R2, R4, R6, R7, R8, R18, R27, R28, R31, R33	11	0Ω resistors (0402)
R3, R5, R19	0	Not installed
R9–R13, R32	6	4.7kΩ ±5% resistors (0402)
R16, R17	2	20kΩ ±5% resistors (0402)
R20	1	1.2kΩ ±5% resistor (0402)

Evaluates: MAX2160

MAX2160 Evaluation Kit

Component List (continued)

DESIGNATION	QTY	DESCRIPTION
R21, R22	2	5.6k Ω \pm 5% resistors (0402)
R23, R24, R26	3	10k Ω \pm 5% resistors (0402)
R29, R30	2	49.9 Ω \pm 1% resistors (0402)
U1	1	ISDB-T receiver MAX2160 40-pin TQFN Maxim MAX2160ETL
U2	1	Hex buffer/driver 14-pin SO Texas Instruments SN74LV07ADR
U3	1	High-speed, single-supply, rail-to-rail buffer MAX4217 8-pin μ MAX [®] Maxim MAX4217EUA
Y1	1	16MHz surface-mount crystal Kyocera Kineski Corporation CX3225SB16000D0FLJ08

μ MAX is a registered trademark of Maxim Integrated Products, Inc.

Component Suppliers

SUPPLIER	PHONE	WEBSITE
AVX	803-946-0690	www.avxcorp.com
Johnson	507-833-8822	www.johnsoncomponents.com
Murata	770-436-1300	www.murata.com

Note: Indicate that you are using the MAX2160 when contacting these suppliers.

Quick Start

The MAX2160 EV kit is fully assembled and factory tested. Follow the instructions in the *Connections and Setup* section for proper device evaluation.

Test Equipment Required

- One power supply capable of supplying at least 500mA, +2.85V
- One dual-output power supply capable of supplying at least 500mA at +3V and -3V
- One RF signal generator capable of delivering at least 0dBm of output power at frequencies up to 1GHz
- One RF spectrum analyzer capable of covering the operating frequency range of the device
- A PC (486DX33 or better) with Windows[®] 95/98, 2000, NT 4.0 or later operating system, 64MB of memory, and an available parallel port
- A 25-pin parallel cable
- (Optional) One multichannel digital oscilloscope
- (Optional) A network analyzer to measure return loss
- (Optional) An ammeter to measure supply current

Windows is a registered trademark of Microsoft Corp.

Connections and Setup

This section provides a step-by-step guide to testing the basic functionality of the EV kit. **Do not turn on DC power or RF signal generators until all connections are completed:**

- 1) Verify that all the desired jumpers are in place (see Table 1).
- 2) With its output disabled, set the DC power supply to +2.85V. Connect the power supply to the VCC (through an ammeter if desired) and GND terminals on the EV kit. If available, set the current limit to 75mA.
- 3) With its output disabled, set the dual-output DC power-supply voltages to +3V and -3V. Connect the +3V, -3V, and GND terminals of the power supply to jumpers J15, J17, and J16, respectively. If available, set the current limits to 50mA.
- 4) With its output disabled, set the RF signal generator to a 767.143MHz frequency and a -60dBm power level. Connect the output of the RF signal generator to J5 on the evaluation board.
- 5) Connect a 25-pin parallel cable between the PC's parallel port and the MAX2160 evaluation board.
- 6) Turn on the \pm 3V power supply, followed by the +2.85V power supply. The supply current from the +2.85V supply should read approximately 44mA. Be sure to adjust the power supply to account for any voltage drop across the ammeter.
- 7) Adjust potentiometers R16 and R17 until the voltages at GC1 and GC2 are approximately 1.5V.
- 8) Install and run the MAX2160 control software. Software is available for download on the Maxim website at www.maxim-ic.com.
- 9) Load the default register settings from the control software by clicking the Defaults tab at the top of the screen.
- 10) Connect either the I or Q output to the spectrum analyzer, or connect both I and Q outputs to the oscilloscope.
- 11) Enable the RF signal generator's output.
- 12) If using a spectrum analyzer, set the center frequency of the analyzer to 571kHz and a span of 100kHz. Set the reference level to 0dBm. Increase the input power of the signal generator until the output level reaches -2dBm. This is the nominal output level for the I and Q channels. The gain of the receiver can be calculated by taking the difference in dB between the input and output power.

MAX2160 Evaluation Kit

Evaluates: MAX2160

If using an oscilloscope, observe the 571kHz sine wave. Increase the input power of the signal generator until the I and Q outputs reach 0.5V_{P-P}. This is the nominal output level for the I and Q channels. The I and Q waveforms will be out-of-phase by approximately 90°.

Voltage gain can be calculated by:

$$\text{Gain} = 20 \times \text{LOG}(V_{\text{OUT_P-P}} / (2 \times \text{sqrt}(2) \times V_{\text{IN_RMS}}))$$

where $V_{\text{IN_RMS}} = \sqrt{(50 \times 10^{[(\text{Pin (dBm)} - 30) / 10]})}$

RF Gain-Control Range (GC1)

To measure the gain-control range in the RF stage, follow the steps below:

- 1) Adjust R17 so V_{GC2} = 1.5V.
- 2) Adjust R16 so V_{GC1} = 0.3V.
- 3) Adjust the RF input power to achieve -2dBm at the I/Q outputs. Record this as the reference output level.
- 4) Adjust R16 until V_{GC1} = 2.7V, and record the change in the I/Q output levels in dB relative to -2dBm. This change in output power is the gain-control range of the RF stage.
- 5) The RF gain-control range will be at least 38dB.

Baseband Gain-Control Range (GC2)

To measure the gain-control range in the baseband stage, follow the steps below:

- 1) Adjust R16 so V_{GC1} = 1.5V.
- 2) Adjust R17 so V_{GC2} = 0.3V.
- 3) Adjust the RF input power to achieve -2dBm at the I/Q outputs. Record this as the reference output level.
- 4) Adjust R17 until V_{GC2} = 2.7V, and record the change in the I/Q output levels in dB relative to -2dBm. This change in output power is the gain-control range of the baseband stage.
- 5) The baseband gain-control range will be at least 57dB.

Layout Considerations

The MAX2160 evaluation board can serve as a reference board layout. Keep traces carrying RF signals as short as possible to minimize radiation and insertion loss. Place supply-decoupling capacitors as close to the device as possible. Solder the package's exposed paddle evenly to the board ground plane for a low-inductance ground connection and for improved thermal dissipation.

In addition, the ground returns for the VCO, VTUNE, and charge pump require special layout consideration. The VCOBYP capacitor (C37) and the VCCVCO bypass capacitor (C19) ground returns must be routed back to the GNDVCO pin and then connected to the overall ground plane at that point (GNDVCO). All loop filter component grounds (C27–C30) and the VCCCP bypass capacitor (C17) ground must all be routed together back to the GNDCP pin. GNDTUNE must also be routed back to the GNDCP pin along with all other grounds from the PLL loop filter. The GNDCP pin must then be connected to the overall ground plane. See Figures 2–6 for recommended board layout.

Table 1. MAX2160 EV Kit Jumper Settings

JUMPER	FUNCTION	JUMPER POSITION
J6	Sets control of the ENTCXO pin	OPEN: ENTCXO pin is controlled by the PC software. SHORT: ENTCXO pin is pulled low (remove R31 in this mode).
J7	Sets control of the GC2 pin	OPEN: GC2 is controlled with an external voltage source applied to TP4 (remove R18 in this mode). SHORT: GC2 is controlled by the voltage set by potentiometer R17.
J18–J26	Set control of VCC1 through VCC9	OPEN: VCC1 through VCC9 can be individually applied. SHORT: VCC1 through VCC9 are connected to the board's main supply voltage, VCC. (Note: These jumpers are hardwired as a short on the board.)
J27	Sets control of the GC1 pin	1-2: GC1 is controlled by the voltage set by potentiometer R16. 2-3: GC1 is controlled by the RF power-detector output (power detector must be enabled).

MAX2160 Evaluation Kit

Evaluates: MAX2160

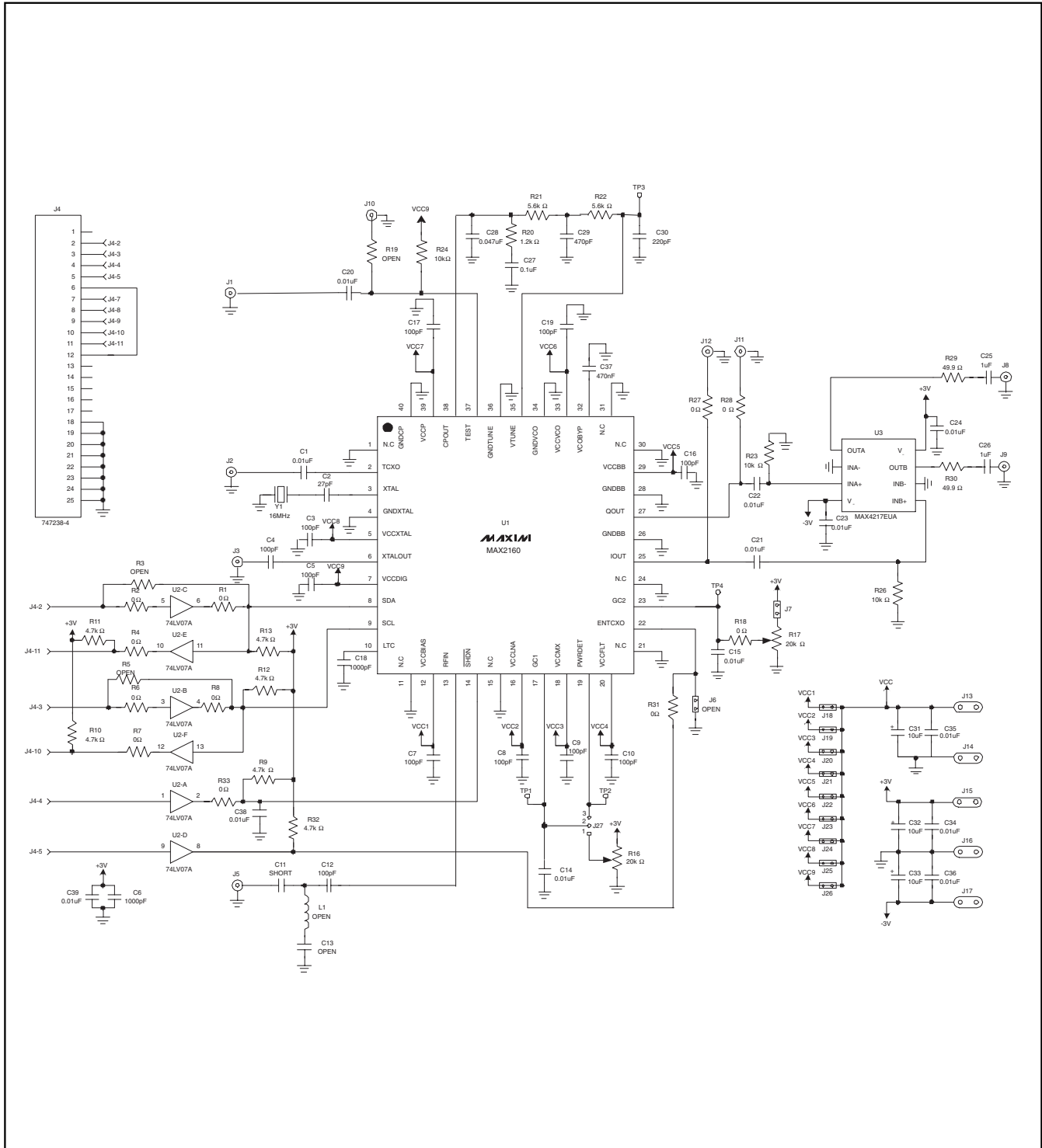

Figure 1. MAX2160 EV Kit Schematic

MAX2160 Evaluation Kit

Evaluates: MAX2160

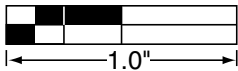
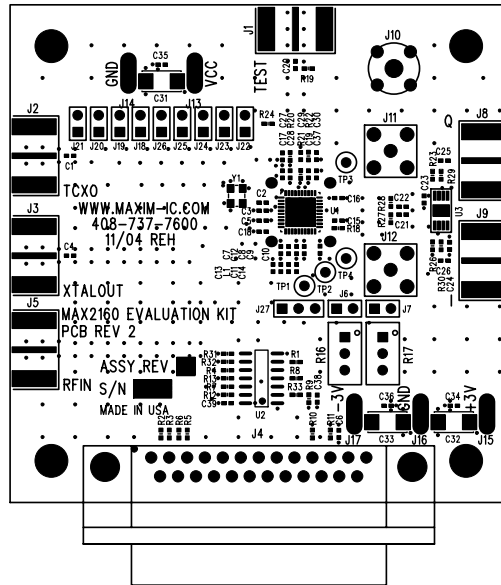

Figure 2. MAX2160 EV Kit PC Board Layout—Component Placement Guide

MAX2160 Evaluation Kit

Evaluates: MAX2160

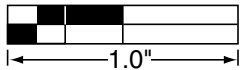
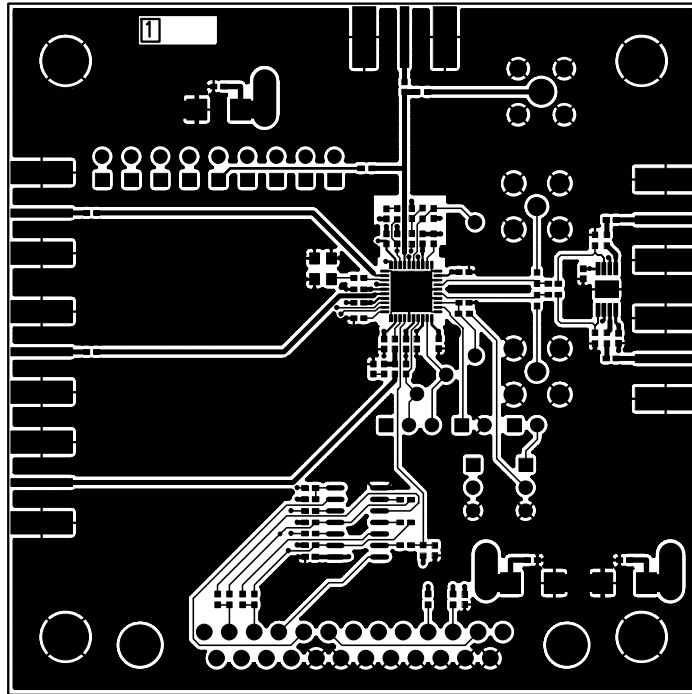

Figure 3. MAX2160 EV Kit PC Board Layout—Primary Component Side

MAX2160 Evaluation Kit

Evaluates: MAX2160

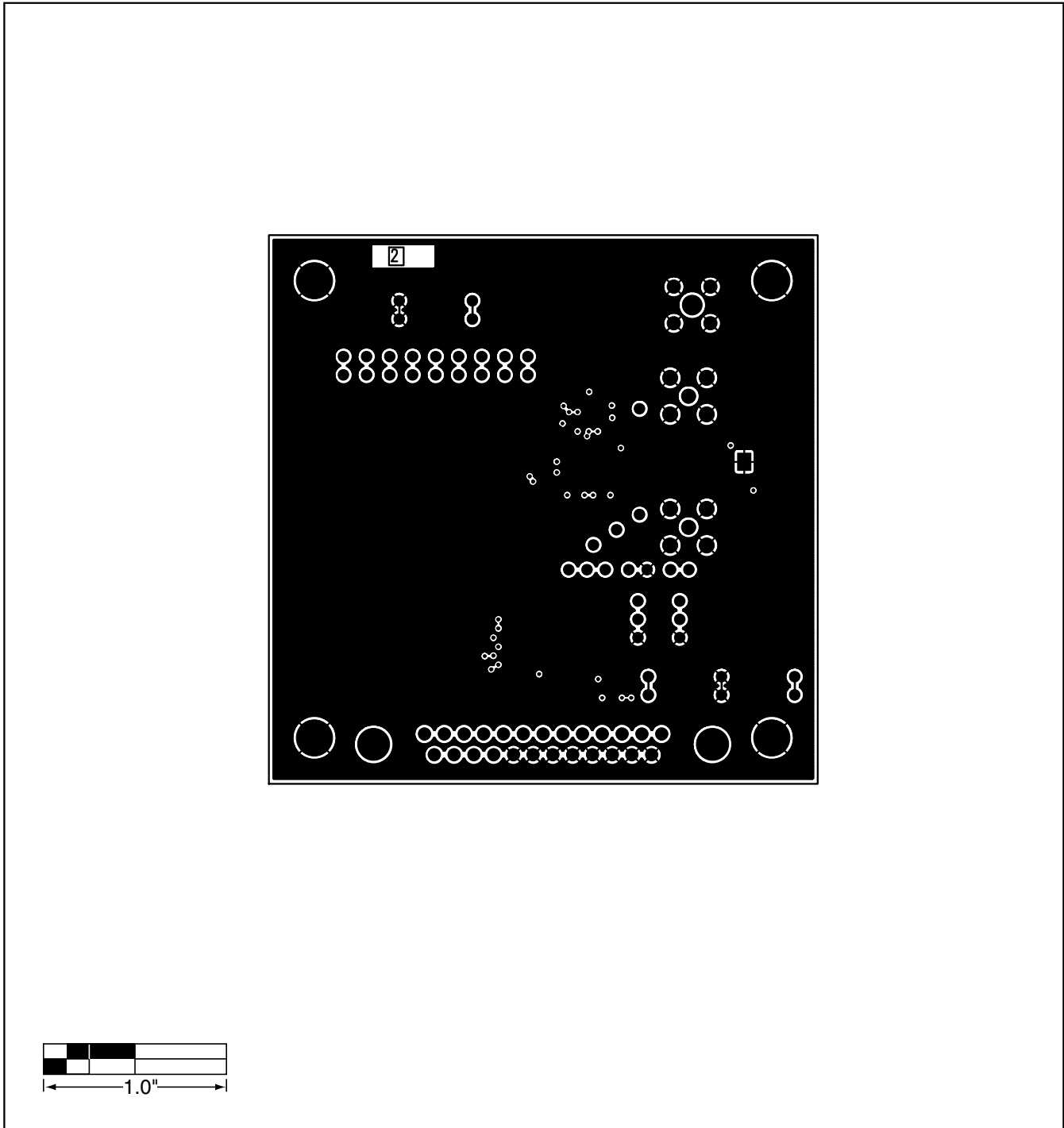

Figure 4. MAX2160 EV Kit PC Board Layout—Inner Layer 2

MAX2160 Evaluation Kit

Evaluates: MAX2160

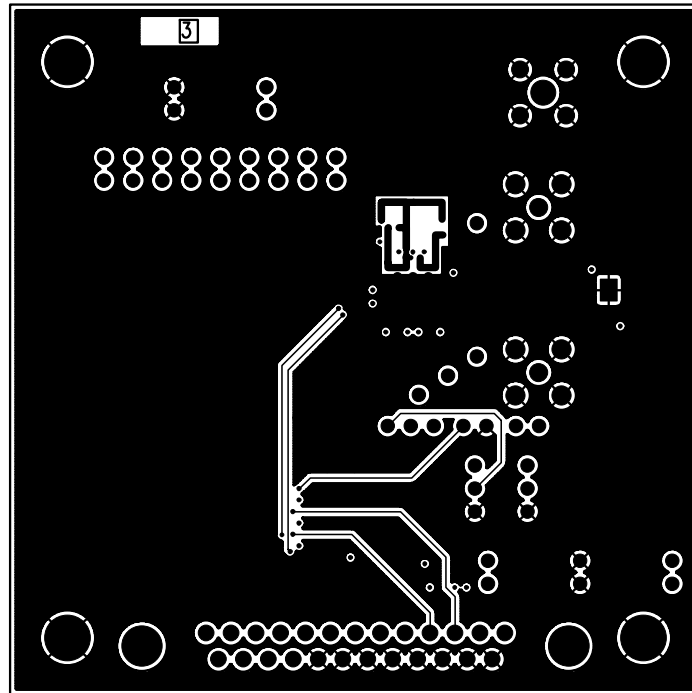

Figure 5. MAX2160 EV Kit PC Board Layout—Inner Layer 3

MAX2160 Evaluation Kit

Evaluates: MAX2160

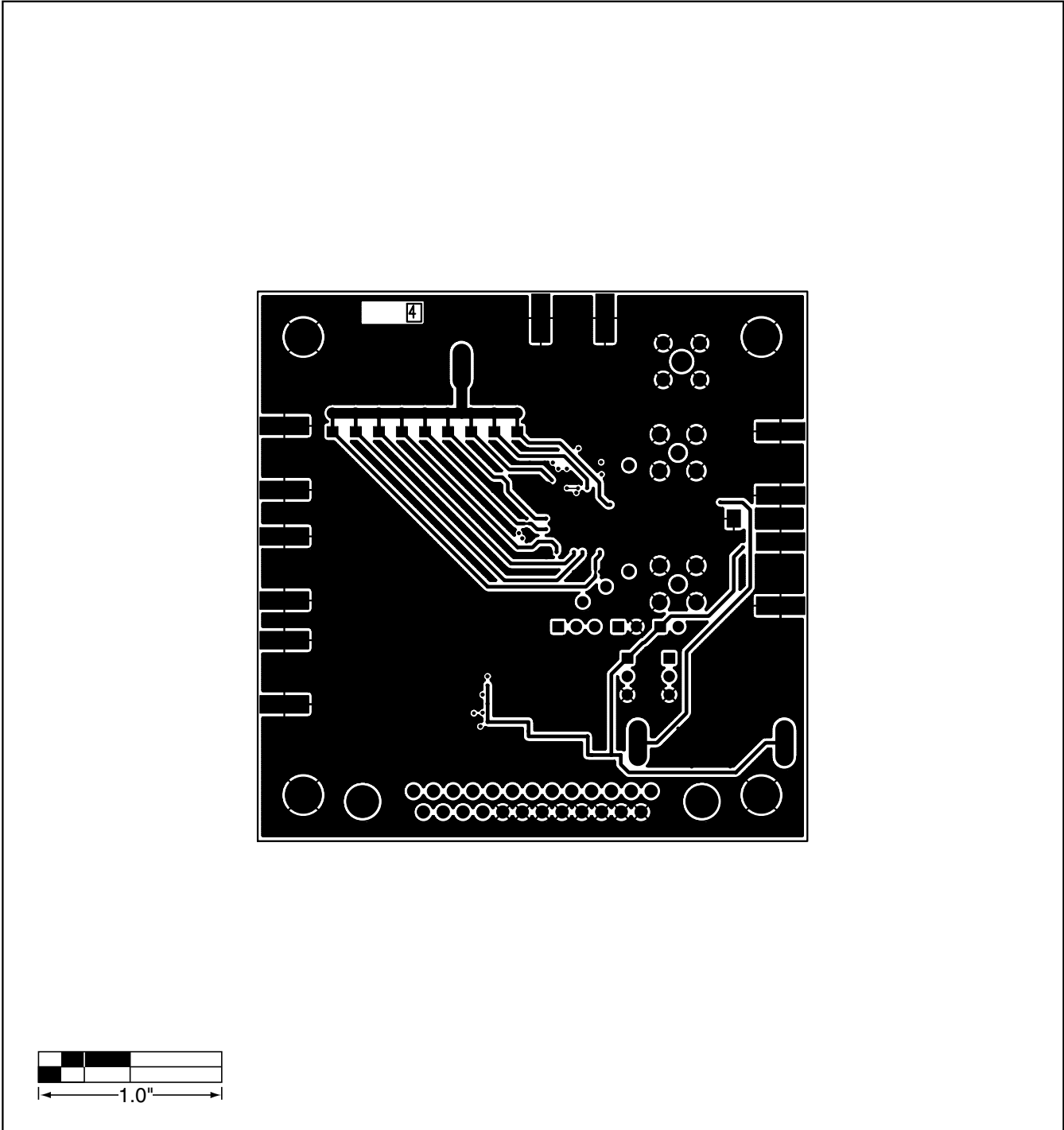

Figure 6. MAX2160 EV Kit PC Board Layout—Secondary Component Side

Maxim cannot assume responsibility for use of any circuitry other than circuitry entirely embodied in a Maxim product. No circuit patent licenses are implied. Maxim reserves the right to change the circuitry and specifications without notice at any time.

Maxim Integrated Products, 120 San Gabriel Drive, Sunnyvale, CA 94086 408-737-7600 _____ 9