

## Features

- Ideal for 802.11a and Hiperlan Applications
- Positive Control Voltages
- +32 dB One dB Compression Point
- Fast Switching Speed
- No External Components Required
- MSOP-8 Package

## Description

The MA0S506AJ is a medium power 5.0 – 6.0 SPDT switch. Typical applications include the transmit/receive functions in 802.11a, Hiperlan, and fixed wireless access applications. All RF impedances are 50 ohms, and all RF ports are internally DC blocked. The switch operates over a typical voltage range of 2.7 to 5.5 volts. The MA0S506AJ is offered in an MSOP-8 package.

The MA0S506AJ is fabricated using M/A-COM's 0.5 micron MESFET process for a low single supply voltage, high linearity, and excellent reliability.

## Ordering Information

Part Number	Description
MA0S506AJ-R7	7 inch, 1000 piece reel
MA0S506AJ-R13	13 inch, 3000 piece reel
MA0S506AJ-SMB	Sample Test Board

## Functional Schematic

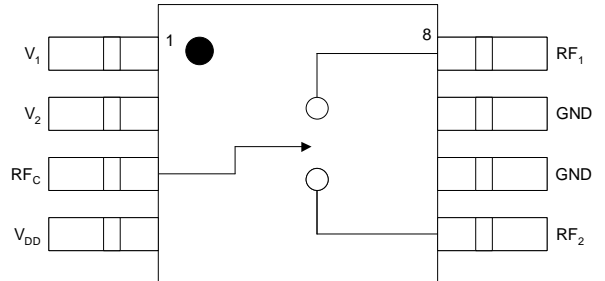

## Pin Configuration

Pin	Function	Description
1	V <sub>1</sub>	Control Voltage 1
2	V <sub>2</sub>	Control Voltage 2
3	RF <sub>C</sub>	RF Common Port
4	V <sub>DD</sub>	Supply Voltage
5	RF <sub>2</sub>	RF Port 2
6	GND	Ground
7	GND	Ground
8	RF <sub>1</sub>	RF Port 1

Specifications subject to change without notice.

- North America: Tel. (800) 366-2266
- Asia/Pacific: Tel.+81-44-844-8296, Fax +81-44-844-8298
- Europe: Tel. +44 (1344) 869 595, Fax+44 (1344) 300 020

Visit [www.macom.com](http://www.macom.com) for additional data sheets and product information.

Electrical Specifications:  $T_A = 25\text{ }^\circ\text{C}$ ,  $Z_0 = 50\ \Omega$ <sup>1</sup>

Parameter	Test Conditions	Units	Min	Typ	Max
Insertion Loss		dB		1.4	1.8
Isolation		dB	25	28	
Return Loss		dB		9	
$T_{RISE}$ , $T_{FALL}$	10% to 90% RF, 90% to 10% RF	nS		10	
$T_{ON}$ , $T_{OFF}$	50% Control to 90% RF, 50% Control to 10% RF	nS		25	
1 dB Compression	$V_1/V_2 = 0/3\text{ V}$ , $V_{DD} = 3\text{ V}$	dBm		32	
	$V_1/V_2 = 0/5\text{ V}$ , $V_{DD} = 5\text{ V}$	dBm		35	
Third Order Intercept		dBm		44	

1. Unless otherwise specified, input power is -10 dBm,  $V_{DD}$  is +5 V, control voltages are 0/+5 V, and test frequency is 5.775 GHz.

Switch Logic Table<sup>1,2</sup>

Insertion Loss Path	Isolated Path	$V_1$	$V_2$
RF <sub>1</sub> /RF <sub>C</sub>	RF <sub>2</sub> /RF <sub>C</sub>	1	0
RF <sub>2</sub> /RF <sub>C</sub>	RF <sub>1</sub> /RF <sub>C</sub>	0	1

- “0” = 0 +/- 0.2 volts
- “1” = +2.7 to +8 volts, equal to  $V_{DD}$

Absolute Maximum Ratings<sup>1</sup>

Parameter	Absolute Maximum
Max Input Power	+ 33 dBm
Control Voltages	+8.0 volts
Supply Voltage	+8.0 volts
Operating Temperature	-40 °C to +100 °C
Channel Temperature	+150 °C
Storage Temperature	-40 °C to +150 °C

1. Exceeding any one or combination of these limits may cause permanent damage.

## Application Information

## Static Sensitivity

Gallium arsenide integrated circuits are ESD sensitive and can be damaged by static electricity. Use proper ESD precautions when handling these devices.

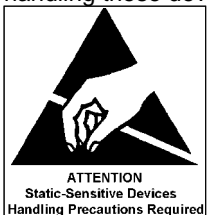

Specifications subject to change without notice.

- North America: Tel. (800) 366-2266
- Asia/Pacific: Tel.+81-44-844-8296, Fax +81-44-844-8298
- Europe: Tel. +44 (1344) 869 595, Fax+44 (1344) 300 020

Visit [www.macom.com](http://www.macom.com) for additional data sheets and product information.

**tyco** / Electronics

**MACOM**

Typical Performance Curves

Insertion Loss vs. Frequency

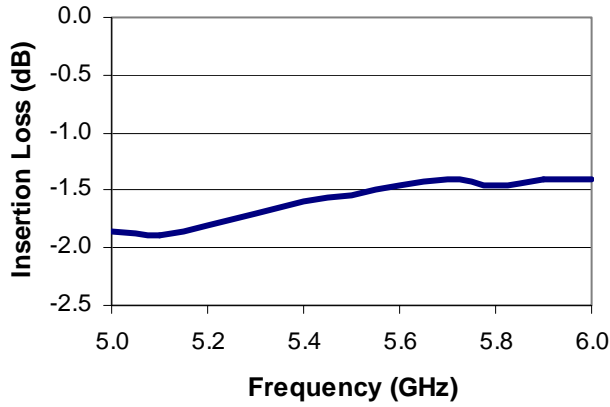

Insertion Loss Variation vs. Frequency

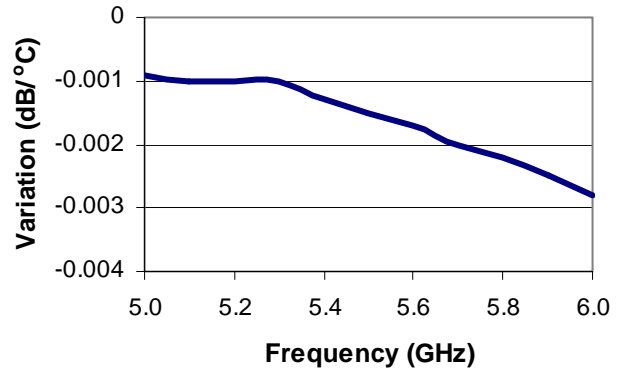

Isolation vs. Frequency

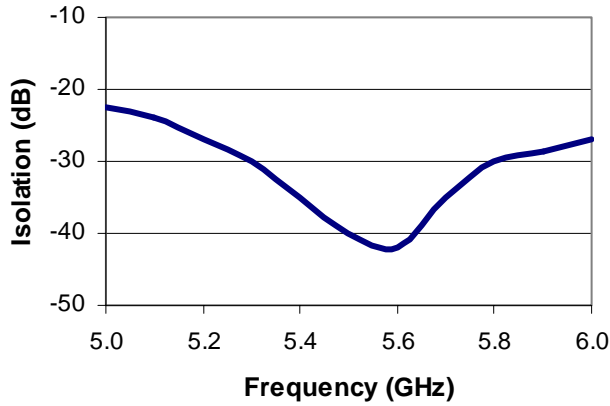

Return Loss vs. Frequency

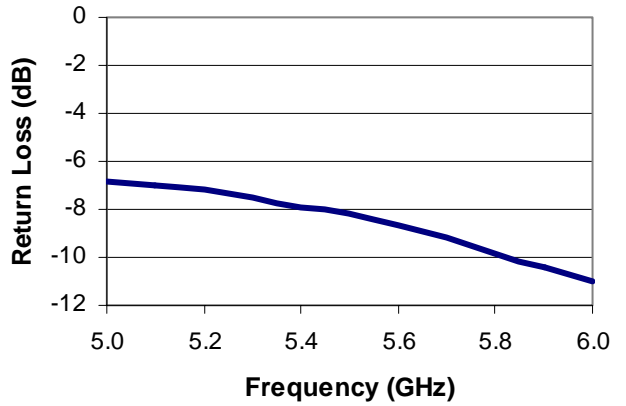

Specifications subject to change without notice.

- North America: Tel. (800) 366-2266
- Asia/Pacific: Tel.+81-44-844-8296, Fax +81-44-844-8298
- Europe: Tel. +44 (1344) 869 595, Fax+44 (1344) 300 020

Visit [www.macom.com](http://www.macom.com) for additional data sheets and product information.



Application Information

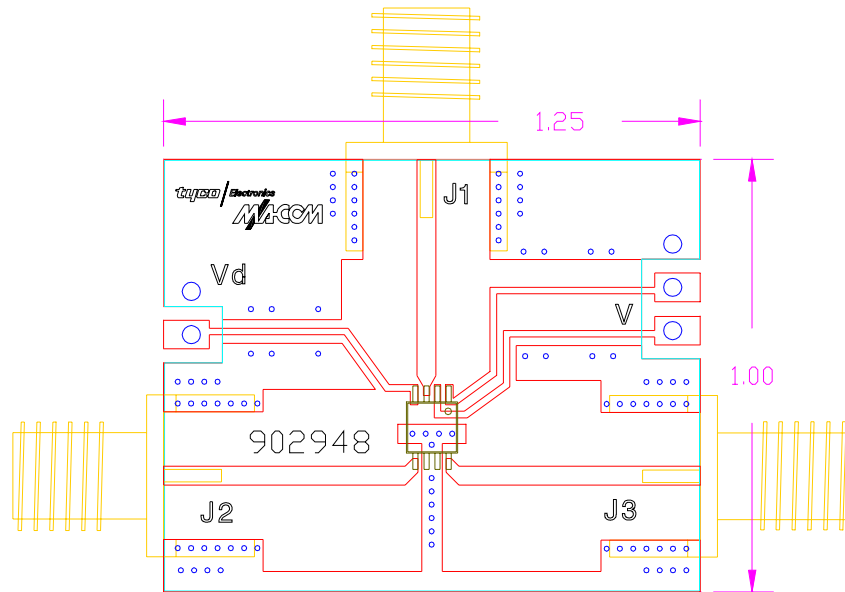

Board material: Rogers Duroid RO4350, 20 mil thick dielectric ( $\epsilon_r=3.48$ ). All RF traces are 50 ohms (43mils wide).

MSOP-8 Package

SYMBOLS	DIMENSIONS IN MILLIMETERS			DIMENSIONS IN INCHES		
	MIN	NOM	MAX	MIN	NOM	MAX
A	0.81	1.02	1.22	0.032	0.040	0.048
A1	0.05	—	0.20	0.002	—	0.008
A2	0.75	0.86	0.97	0.030	0.034	0.038
b	0.25	0.30	0.40	0.010	0.012	0.015
C	0.13	0.15	0.23	0.005	0.006	0.009
D	2.90	3.00	3.10	0.114	0.118	0.122
E	4.80	4.90	5.00	0.189	0.193	0.197
E1	2.90	3.00	3.10	0.114	0.118	0.122
e	—	0.65	—	—	0.026	—
L	0.40	0.53	0.70	0.016	0.021	0.026
y	—	—	0.10	—	—	0.004
$\theta$	0°	—	6°	0°	—	6°

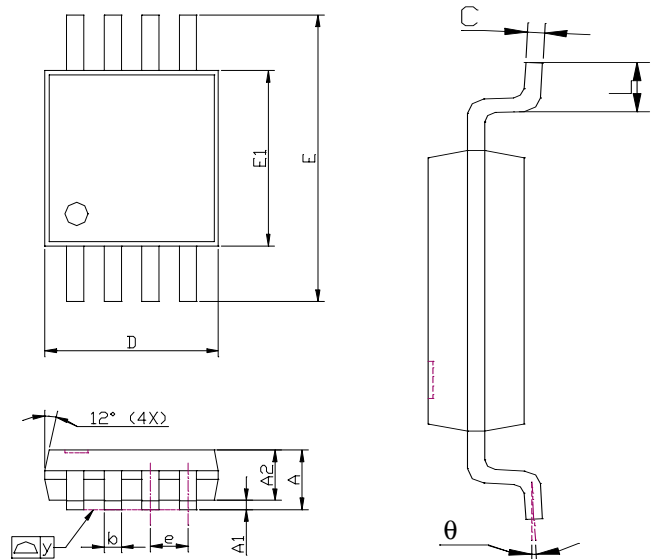

NOTES:

1. Package body sizes exclude mold flash and gate burrs.
2. Dimension L is measured in the gauge plane.
3. Tolerance 0.10 mm unless otherwise specified.
4. Controlling dimension is millimeter. Converted inch dimensions are not necessarily exact.
5. Package follows JEDEC Standards.

Specifications subject to change without notice.

- North America: Tel. (800) 366-2266
- Asia/Pacific: Tel.+81-44-844-8296, Fax +81-44-844-8298
- Europe: Tel. +44 (1344) 869 595, Fax+44 (1344) 300 020

Visit [www.macom.com](http://www.macom.com) for additional data sheets and product information.

