



SAW Components

Data Sheet M 3654 K





SAW Components

M 3654 K

IF Filter for Quasi/Split Sound Applications

45,75 MHz

Data Sheet

Standard

Plastic package **DIP10K**

- M/N

Features

- TV IF filter for quasi/split sound applications (separate picture and sound channel)
- Picture channel with Nyquist slope and sound suppression
- High color carrier level
- Customized group delay predistortion
- Sound channel with passband for sound carrier only

Terminals

- Tinned CuFe alloy

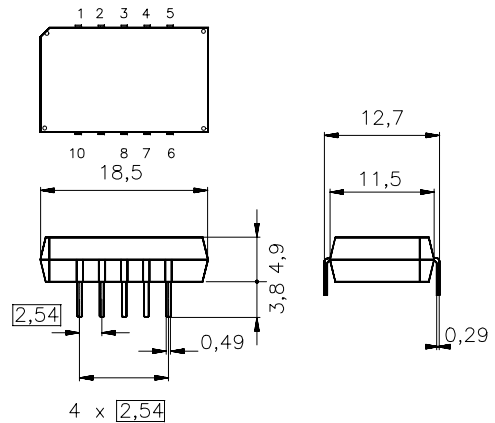

Dimensions in mm, approx. weight 1,8 g

Pin configuration

- 1 Input - sound
- 2 Input - ground
- 3; 8 Chip carrier - ground
- 4; 5 Output - sound
- 6; 7 Output - picture
- 9 Free
- 10 Input picture

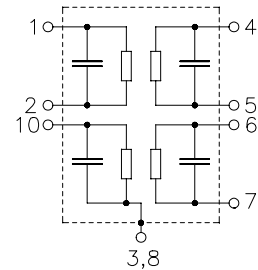

Type	Ordering code	Marking and package according to	Packing according to
M 3654 K	B39458-M3654-K100	C61157-A2-A3	F61074-V8068-Z000

Maximum ratings

Operable temperature range	T_A	-25/+65	°C	
Storage temperature range	T_{stg}	-40/+85	°C	
DC voltage	V_{DC}	5	V	between any terminals
AC voltage	V_{pp}	10	V	between any terminals



SAW Components

M 3654 K

IF Filter for Quasi/Split Sound Applications

45,75 MHz

Data Sheet

Characteristics of picture channel

Reference temperature: $T_A = 25 (45)^\circ\text{C}$
 Terminating source impedance: $Z_S = 50 \Omega$
 Terminating load impedance: $Z_L = 2 \text{ k}\Omega \parallel 3 \text{ pF}$

		min.	typ.	max.	
Insertion attenuation α					
Reference level for the following data	44,06 (44,00) MHz	11,5	13,0	14,5	dB
Relative attenuation α_{rel}					
Picture carrier	45,81 (45,75) MHz	5,3	6,0	6,7	dB
Color carrier	42,23 (42,17) MHz	-0,1	0,9	1,9	dB
Sound carrier	41,31 (41,25) MHz	25,0	39,0	—	dB
Adjacent picture carrier	39,81 (39,75) MHz	45,0	56,0	—	dB
Adjacent sound carrier	47,31 (47,25) MHz	44,0	51,0	—	dB
Lower sidelobe	35,06 ... 39,81 (35,00 ... 39,75) MHz	37,0	41,0	—	dB
Upper sidelobe	47,31 ... 55,06 (47,25 ... 55,00) MHz	37,0	42,0	—	dB
Reflected wave signal suppression					
1,2 μs ... 6,0 μs after main pulse (test pulse 250 ns, carrier frequency 44,06 MHz)		42,0	52,0	—	dB
Feedthrough signal suppression					
1,2 μs ... 1,1 μs before main pulse (test pulse 250 ns, carrier frequency 44,06 MHz)		—	50,0	—	dB
Group delay predistortion (reference frequency 45,81 MHz)					
	42,23 (42,17) MHz	—	-40	—	ns
Impedance at 44,06 MHz					
	Input: $Z_{\text{IN}} = R_{\text{IN}} \parallel C_{\text{IN}}$	—	1,2 \parallel 12,4	—	k Ω \parallel pF
	Output: $Z_{\text{OUT}} = R_{\text{OUT}} \parallel C_{\text{OUT}}$	—	1,2 \parallel 3,5	—	k Ω \parallel pF
Temperature coefficient of frequency TC_f		—	-72	—	ppm/K



SAW Components

M 3654 K

IF Filter for Quasi/Split Sound Applications

45,75 MHz

Data Sheet

Characteristics of sound channel

Reference temperature: $T_A = 25 (45) \text{ }^\circ\text{C}$
 Terminating source impedance: $Z_S = 50 \text{ } \Omega$
 Terminating load impedance: $Z_L = 2 \text{ k}\Omega \parallel 3 \text{ pF}$

		min.	typ.	max.	
Insertion attenuation					
	α				
Reference level for the following data	41,31 (41,25) MHz	9,4	10,9	12,4	dB
Pass bandwidth					
$\alpha_{\text{rel}} \leq 3 \text{ dB}$	$B_{3\text{dB}}$	—	0,6	—	MHz
$\alpha_{\text{rel}} \leq 20 \text{ dB}$	$B_{20\text{dB}}$	—	1,35	—	MHz
Relative attenuation					
	α_{rel}				
Picture carrier	45,81 (45,75) MHz	45,0	55,0	—	dB
Color carrier	42,23 (42,17) MHz	22,0	26,0	—	dB
Adjacent picture carrier	39,81 (39,75) MHz	40,0	47,0	—	dB
Adjacent sound carrier	47,31 (47,25) MHz	43,0	52,0	—	dB
Lower sidelobe					
	35,06 ... 39,06 (35,00 ... 39,00) MHz	34,0	38,0	—	dB
	39,06 ... 39,41 (39,00 ... 39,35) MHz	36,0	42,0	—	dB
Upper sidelobe					
	47,31 ... 55,06 (47,25 ... 55,00) MHz	42,0	48,0	—	dB
Group delay ripple (p-p)					
	$\Delta\tau$				
	41,01 ... 41,61 (40,95 ... 41,55) MHz	—	80	—	ns
Impedance at 41,31 MHz					
	Input: $Z_{\text{IN}} = R_{\text{IN}} \parallel C_{\text{IN}}$	—	0,6 \parallel 14,2	—	k Ω \parallel pF
	Output: $Z_{\text{OUT}} = R_{\text{OUT}} \parallel C_{\text{OUT}}$	—	2,8 \parallel 2,4	—	k Ω \parallel pF
Temperature coefficient of frequency					
	TC_f	—	-72	—	ppm/K



SAW Components

M 3654 K

IF Filter for Quasi/Split Sound Applications

45,75 MHz

Data Sheet

Frequency response of picture channel

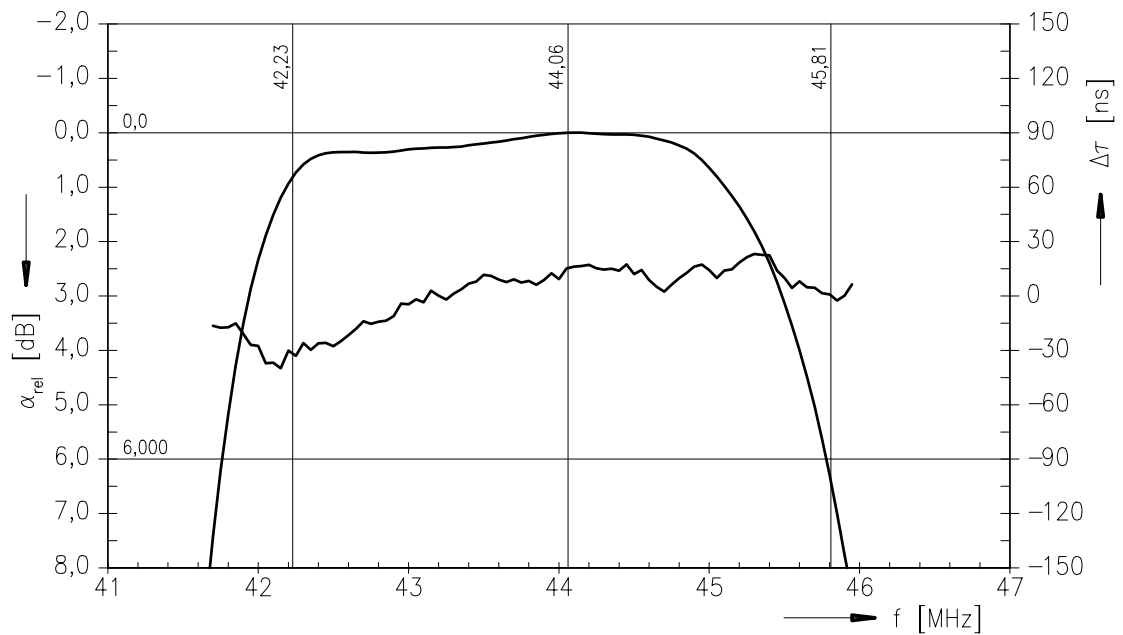
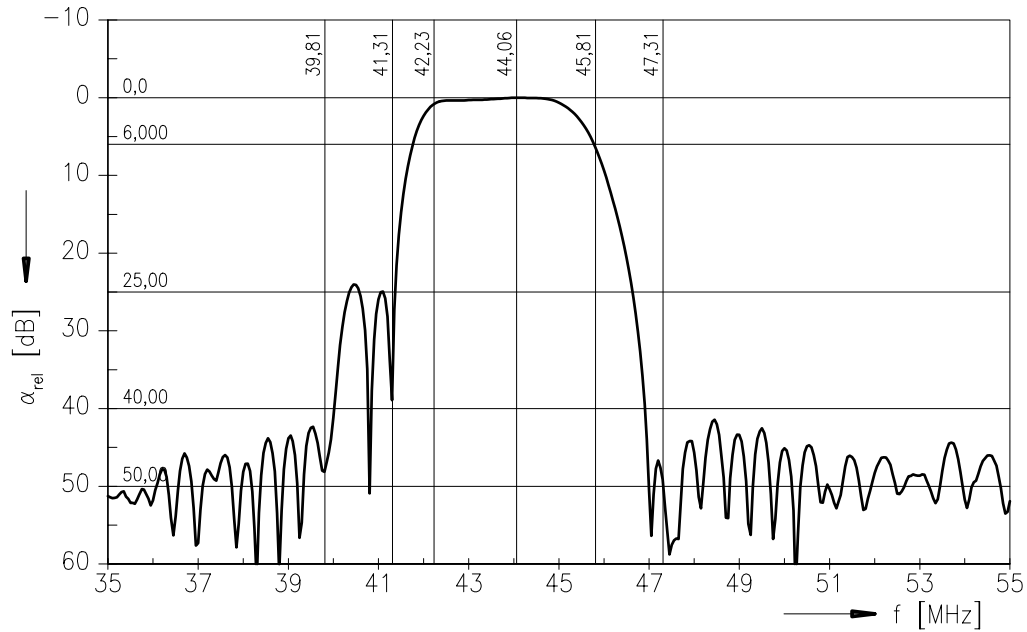



SAW Components

M 3654 K

IF Filter for Quasi/Split Sound Applications

45,75 MHz

Data Sheet

Frequency response of picture channel

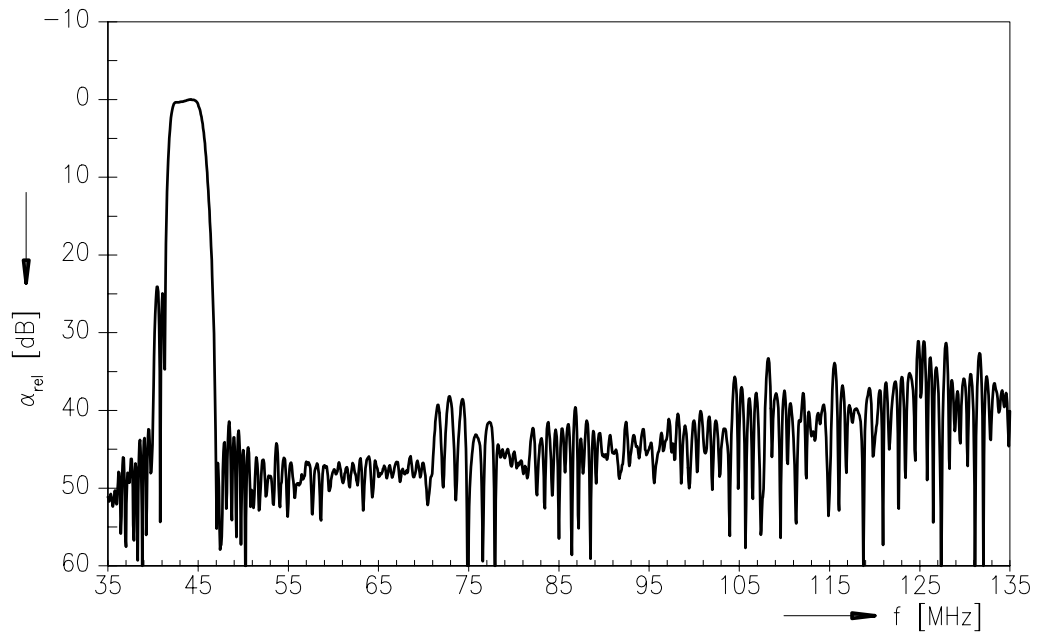

Time domain response of picture channel

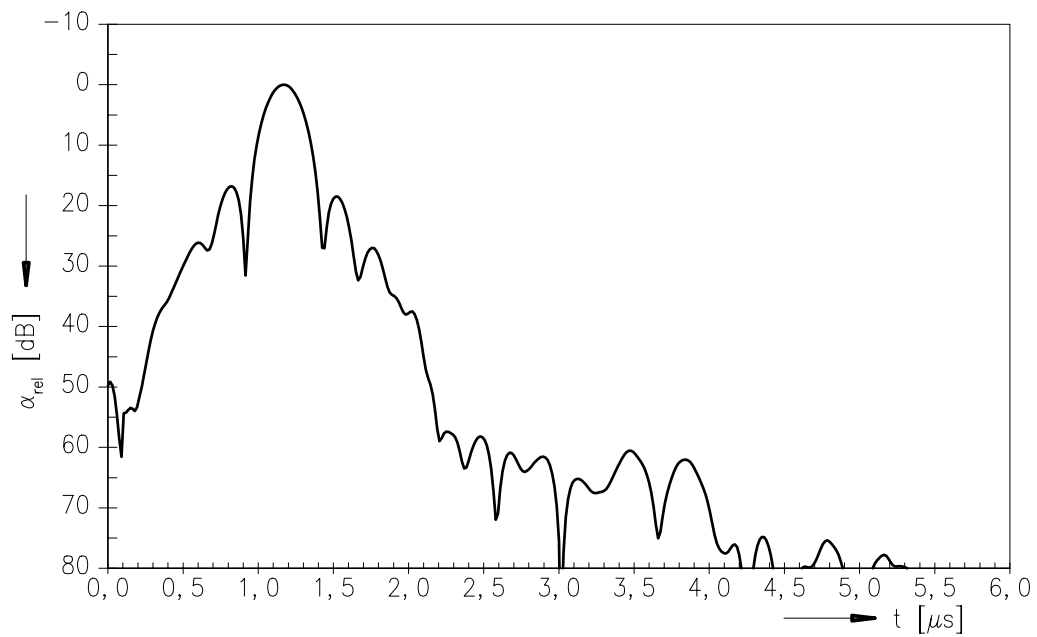



SAW Components

M 3654 K

IF Filter for Quasi/Split Sound Applications

45,75 MHz

Data Sheet

Frequency response of sound channel

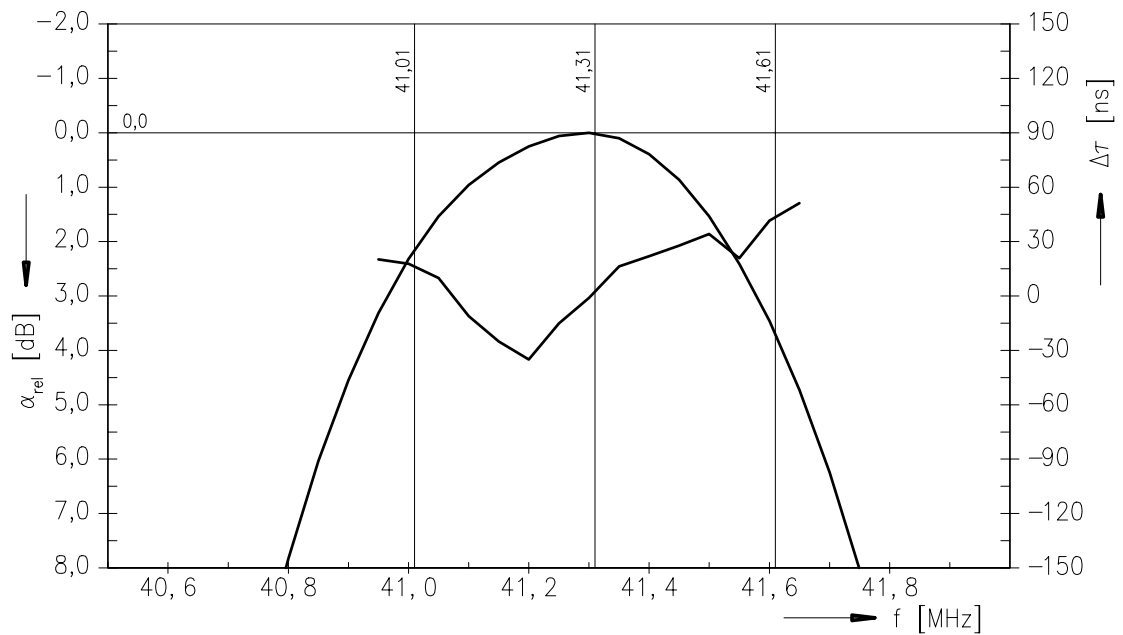
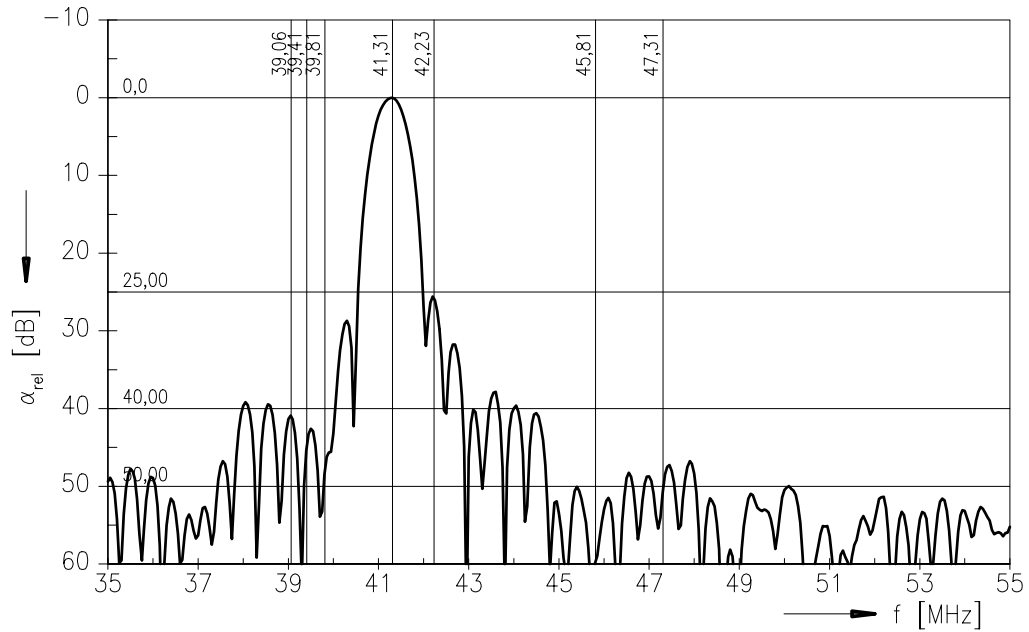



SAW Components

M 3654 K

IF Filter for Quasi/Split Sound Applications

45,75 MHz

Data Sheet

Published by EPCOS AG

Surface Acoustic Wave Components Division, SAW CE MM PD

P.O. Box 80 17 09, D-81617 München

© EPCOS AG 2001. All Rights Reserved.

As far as patents or other rights of third parties are concerned, liability is only assumed for components per se, not for applications, processes and circuits implemented within components or assemblies.

The information describes the type of component and shall not be considered as assured characteristics.

Terms of delivery and rights to change design reserved.

For questions on technology, prices and delivery please contact the sales offices of EPCOS AG or the international representatives.

Due to technical requirements components may contain dangerous substances. For information on the type in question please also contact one of our sales offices.