

Hyper SIDELED® Hyper-Bright LED

LS A676, LA A676, LO A676, LY A676



Besondere Merkmale

- **Gehäusetypp:** weißes SMT Gehäuse
- **Besonderheit des Bauteils:** Abstrahlung parallel zur Platine, deshalb ideal zur Einkopplung in Lichtleiter
- **Wellenlänge:** 633 nm (super-rot), 615 nm (amber), 606 nm (orange), 587 nm (gelb)
- **Abstrahlwinkel:** Lambertscher Strahler (120°)
- **Technologie:** InGaAlP
- **optischer Wirkungsgrad:** 11 lm/W (gelb, orange, amber), 7 lm/W (super-rot)
- **Gruppierungsparameter:** Lichtstärke, Wellenlänge
- **Verarbeitungsmethode:** für alle SMT-Bestücktechniken geeignet
- **Lötmethode:** IR Reflow Löten und Wellenlöten (TTW)
- **Vorbehandlung:** nach JEDEC Level 2
- **Gurtung:** 12 mm Gurt mit 2000/Rolle, ø330 mm

Anwendungen

- optischer Indikator
- Einkopplung in Lichtleiter
- Hinterleuchtung (LCD, Schalter, Tasten, Displays, Werbebeleuchtung, Allgemeinbeleuchtung)
- Innenbeleuchtung im Automobilbereich (z.B. Instrumentenbeleuchtung, u.ä.)
- Markierungsbeleuchtung (z.B. Stufen, Fluchtwege, u.ä.)
- Signal- und Symbolleuchten

Features

- **package:** white SMT package
- **feature of the device:** radiation direction parallel to PCB, so an ideal LED for coupling in light guides
- **wavelength:** 633 nm (super-red), 615 (amber), 606 nm (orange), 587 nm (yellow)
- **viewing angle:** Lambertian Emitter (120°)
- **technology:** InGaAlP
- **optical efficiency:** 11 lm/W (yellow, orange, amber), 7 lm/W (super-red)
- **grouping parameter:** luminous intensity, wavelength
- **assembly methods:** suitable for all SMT assembly methods
- **soldering methods:** IR reflow soldering and TTW soldering
- **preconditioning:** acc. to JEDEC Level 2
- **taping:** 12 mm tape with 2000/reel, ø330 mm

Applications

- optical indicators
- coupling into light guides
- backlighting (LCD, switches, keys, displays, illuminated advertising, general lighting)
- interior automotive lighting. (e.g. dashboard backlighting, etc.)
- marker lights (e.g. steps, exit ways, etc.)
- signal and symbol luminaire

Typ	Emissions- farbe	Farbe der Lichtaustritts- fläche	Lichtstärke	Lichtstrom	Bestellnummer
Type	Color of Emission	Color of the Light Emitting Area	Luminous Intensity $I_F = 20 \text{ mA}$ $I_V \text{ (mcd)}$	Luminous Flux $I_F = 20 \text{ mA}$ $\Phi_V \text{ (mlm)}$	Ordering Code
LS A676-N2P2-1 LS A676-P2R1-1	super-red	colorless clear	35.5 ... 71.0 56.0 ... 140.0	150 (typ.) 280 (typ.)	Q62703Q5074 Q62703Q5075
LA A676-Q1R1-1 LA A676-R1S2-1	amber	colorless clear	71.0 ... 140.0 112.0 ... 280.0	310 (typ.) 560 (typ.)	Q62703Q4972 Q62703Q4973
LO A676-Q1R1-24 LO A676-R1S2-24	orange	colorless clear	71.0 ... 140.0 112.0 ... 280.0	310 (typ.) 560 (typ.)	Q62702Q5032 Q62702Q5033
LY A676-P2Q2-26 LY A676-Q2S1-26	yellow	colorless clear	56.0 ... 112.0 90.0 ... 224.0	240 (typ.) 440 (typ.)	Q62703Q5111 Q62703Q5112

Anm.: -1 gesamter Farbbereich (siehe **Seite 4**)

-24 gesamter Farbbereich, Lieferung in Einzelgruppen (siehe **Seite 5**)

-26 gesamter Farbbereich, Lieferung in Einzelgruppen (siehe **Seite 5**)

Die Standardlieferform von Serientypen beinhaltet eine untere bzw. eine obere Familiengruppe, die aus nur 3 bzw. 4 Halbgruppen besteht. Einzelne Halbgruppen sind nicht erhältlich.
In einer Verpackungseinheit / Gurt ist immer nur eine Halbgruppe enthalten.

Note: -1 Total color tolerance range (please see **page 4**)

-24 Total color tolerance range, delivery in single groups (please see **page 5**)

-26 Total color tolerance range, delivery in single groups (please see **page 5**)

The standard shipping format for serial types includes a lower or upper family group of 3 or 4 individual groups. Individual half groups are not available.

No packing unit / tape ever contains more than one luminous intensity half group.

Grenzwerte
Maximum Ratings

Bezeichnung Parameter	Symbol Symbol	Werte Values		Einheit Unit
		LS, LO, LA	LY	
Betriebstemperatur Operating temperature range	T_{op}	- 55 ... + 100		°C
Lagertemperatur Storage temperature range	T_{stg}	- 55 ... + 100		°C
Sperrschichttemperatur Junction temperature	T_j	+ 100		°C
Durchlassstrom Forward current	I_F	30		mA
Stoßstrom Surge current $t \leq 10 \mu s, D = 0.005$	I_{FM}	1	0.2	A
Sperrspannung ¹⁾ Reverse voltage	V_R	12		V
Leistungsaufnahme Power consumption	P_{tot}	80		mW
Wärmewiderstand Thermal resistance Sperrschicht/Umgebung Junction/ambient	$R_{th JA}$	530		K/W
Sperrschicht/Löt看pad Junction/solder point Montage auf PC-Board FR 4 (Padgröße $\geq 16 \text{ mm}^2$) mounted on PC board FR 4 (pad size $\geq 16 \text{ mm}^2$)	$R_{th JS}$	300		K/W

¹⁾ für kurzzeitigen Betrieb geeignet / suitable for short term application

Kennwerte ($T_A = 25\text{ °C}$)

Characteristics

Bezeichnung Parameter	Symbol Symbol	Werte Values				Einheit Unit
		LS	LA	LO	LY	
Wellenlänge des emittierten Lichtes (typ.) Wavelength at peak emission $I_F = 20\text{ mA}$	λ_{peak}	645	622	610	591	nm
Dominantwellenlänge ¹⁾ (typ.) Dominant wavelength ¹⁾ $I_F = 20\text{ mA}$	λ_{dom}	633 ± 6	615 ± 6	606 -6/+3	587 -7/+8	nm
Spektrale Bandbreite bei 50 % $I_{\text{rel max}}$ (typ.) Spectral bandwidth at 50 % $I_{\text{rel max}}$ $I_F = 20\text{ mA}$	$\Delta\lambda$	16	16	16	15	nm
Abstrahlwinkel bei 50 % I_V (Vollwinkel) (typ.) Viewing angle at 50 % I_V	2ϕ	120	120	120	120	Grad deg.
Durchlassspannung ²⁾ (typ.) Forward voltage ²⁾ (max.) $I_F = 20\text{ mA}$	V_F V_F	2.0 2.4	2.0 2.4	2.0 2.4	2.0 2.4	V V
Sperrstrom (typ.) Reverse current (max.) $V_R = 12\text{ V}$	I_R I_R	0.01 10	0.01 10	0.01 10	0.01 10	μA μA
Temperaturkoeffizient von λ_{peak} (typ.) Temperature coefficient of λ_{peak} $I_F = 20\text{ mA}; -10\text{ °C} \leq T \leq 100\text{ °C}$	$TC_{\lambda_{\text{peak}}}$	0.14	0.13	0.13	0.13	nm/K
Temperaturkoeffizient von λ_{dom} (typ.) Temperature coefficient of λ_{dom} $I_F = 20\text{ mA}; -10\text{ °C} \leq T \leq 100\text{ °C}$	$TC_{\lambda_{\text{dom}}}$	0.05	0.06	0.07	0.10	nm/K
Temperaturkoeffizient von V_F (typ.) Temperature coefficient of V_F $I_F = 20\text{ mA}; -10\text{ °C} \leq T \leq 100\text{ °C}$	TC_V	-2.0	-1.8	-1.7	-2.5	mV/K
Optischer Wirkungsgrad (typ.) Optical efficiency $I_F = 20\text{ mA}$	η_{opt}	7	11	11	11	lm/W

¹⁾ Wellenlängen werden mit einer Stromeinprägungsdauer von 25 ms und einer Genauigkeit von ±1 nm ermittelt.
Wavelengths are tested at a current pulse duration of 25 ms and a tolerance of ±1 nm.

²⁾ Spannungswerte werden mit einer Stromeinprägungsdauer von 1 ms und einer Genauigkeit von ±0,1 V ermittelt.
Voltages are tested at a current pulse duration of 1 ms and a tolerance of ±0.1 V.

1) Wellenlängengruppen / Wavelength groups

Gruppe Group	yellow		orange		Einheit Unit
	min.	max.	min.	max.	
2	580	583	600	603	nm
3	583	586	603	606	nm
4	586	589	606	609	nm
5	589	592			nm
6	592	595			nm

Helligkeits-Gruppierungsschema
Luminous Intensity Groups

Lichtgruppe Luminous Intensity Group	Lichtstärke Luminous Intensity I_V (mcd)	Lichtstrom Luminous Flux Φ_V (mlm)
N2	35.5 ... 45.0	120 (typ.)
P1	45.0 ... 56.0	150 (typ.)
P2	56.0 ... 71.0	190 (typ.)
Q1	71.0 ... 90.0	240 (typ.)
Q2	90.0 ... 112.0	300 (typ.)
R1	112.0 ... 140.0	380 (typ.)
R2	140.0 ... 180.0	480 (typ.)
S1	180.0 ... 224.0	600 (typ.)
S2	224.0 ... 280.0	760 (typ.)

Helligkeitswerte werden mit einer Stromeinprägedauer von 25 ms und einer Genauigkeit von $\pm 11\%$ ermittelt.
Luminous intensity is tested at a current pulse duration of 25 ms and a tolerance of $\pm 11\%$.

Gruppenbezeichnung auf Etikett
Group Name on Label

Beispiel: P2-3
Example: P2-3

Lichtgruppe Luminous Intensity Group	Halbgruppe Half Group	Wellenlänge Wavelength
P	2	3

Relative spektrale Emission $I_{rel} = f(\lambda)$, $T_A = 25\text{ °C}$, $I_F = 20\text{ mA}$

Relative Spectral Emission

$V(\lambda)$ = spektrale Augenempfindlichkeit

Standard eye response curve

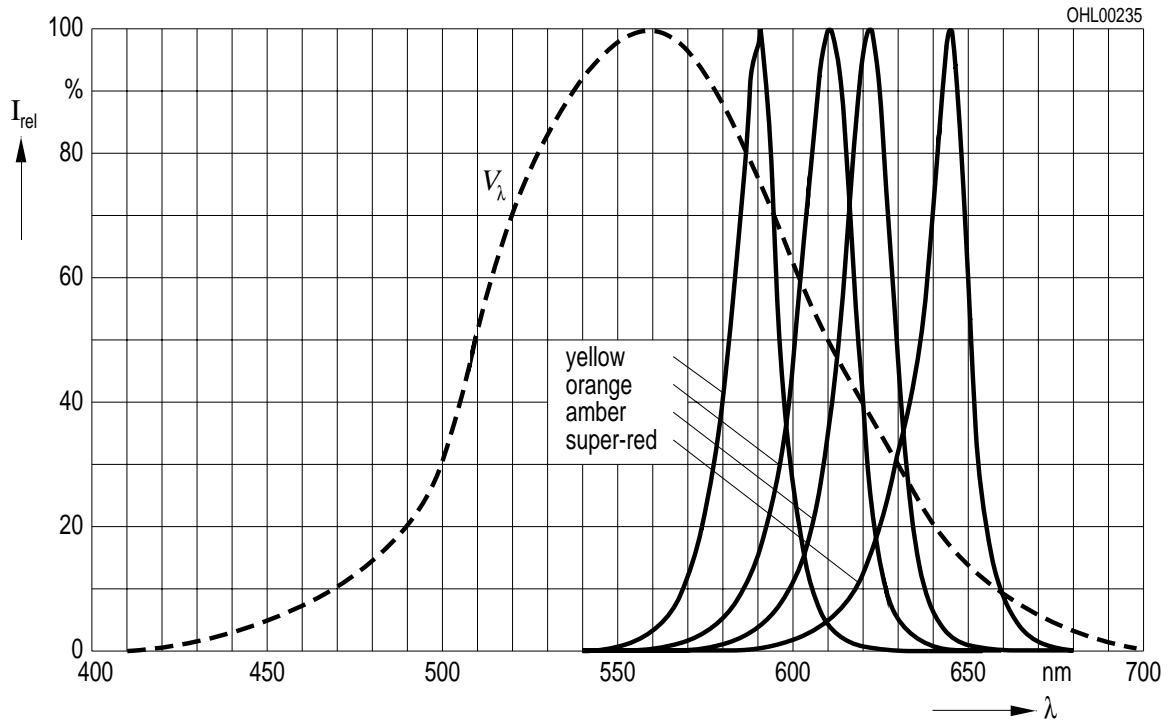

Abstrahlcharakteristik $I_{rel} = f(\varphi)$

Radiation Characteristic

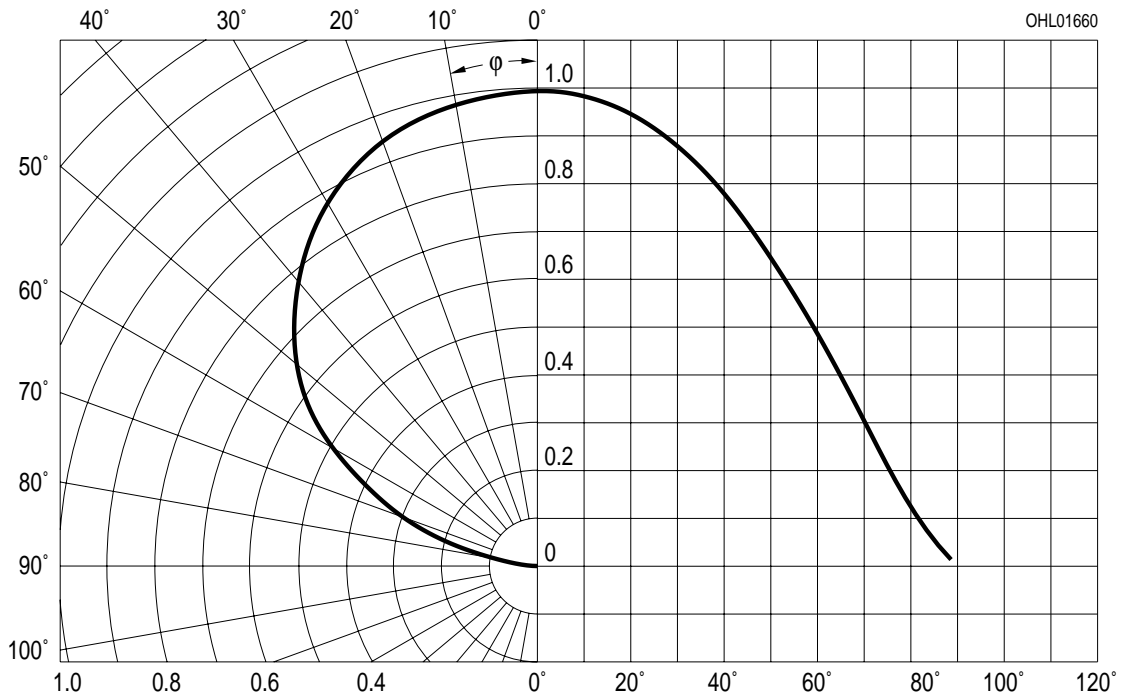

Durchlassstrom $I_F = f(V_F)$
Forward Current

$T_A = 25\text{ °C}$

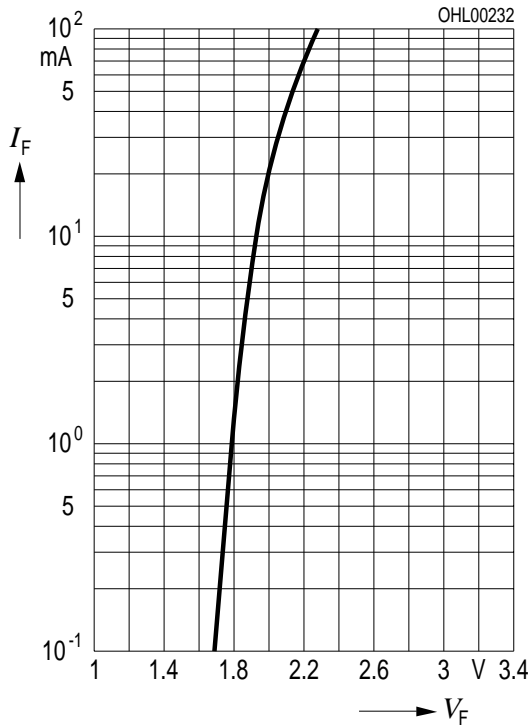

Relative Lichtstärke $I_V/I_{V(20\text{ mA})} = f(I_F)$
Relative Luminous Intensity

$T_A = 25\text{ °C}$

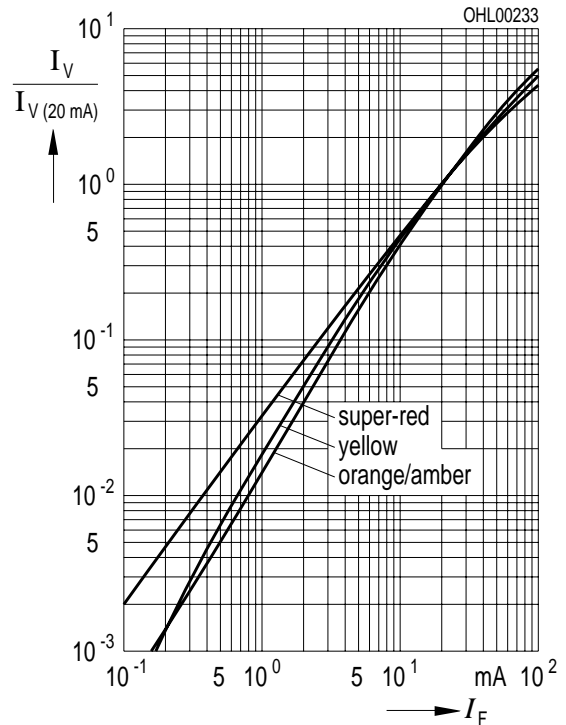

Maximal zulässiger Durchlassstrom $I_F = f(T)$
Max. Permissible Forward Current

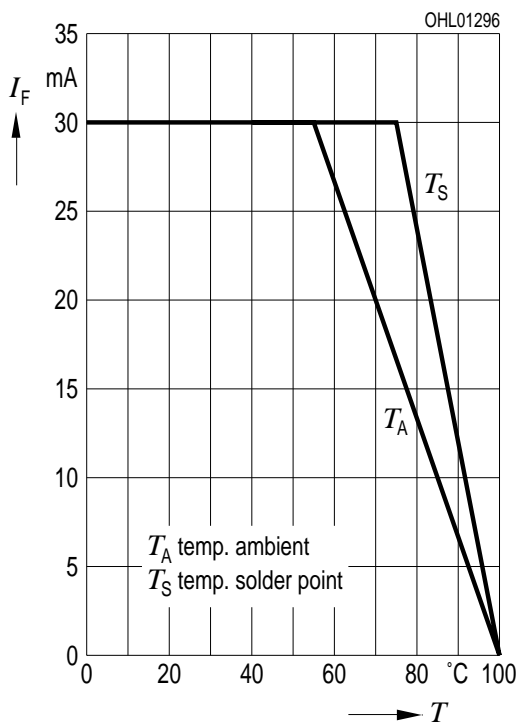

Relative Lichtstärke $I_V/I_{V(25\text{ °C})} = f(T_A)$
Relative Luminous Intensity

$I_F = 20\text{ mA}$

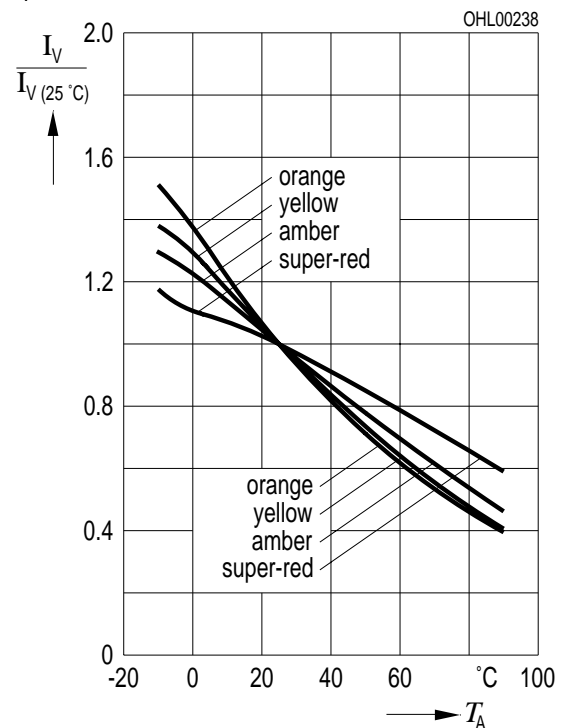

Zulässige Impulsbelastbarkeit $I_F = f(t_p)$
Permissible Pulse Handling Capability
 Duty cycle $D =$ parameter, $T_A = 25\text{ °C}$
LS, LA, LO

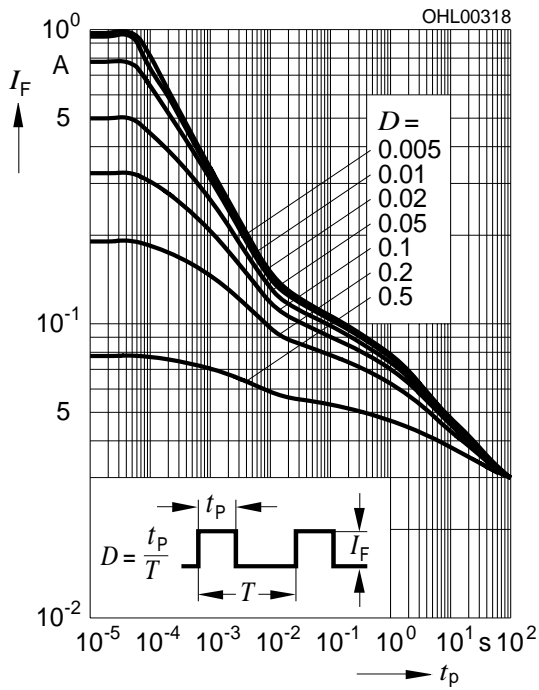

Zulässige Impulsbelastbarkeit $I_F = f(t_p)$
Permissible Pulse Handling Capability
 Duty cycle $D =$ parameter, $T_A = 25\text{ °C}$
LY

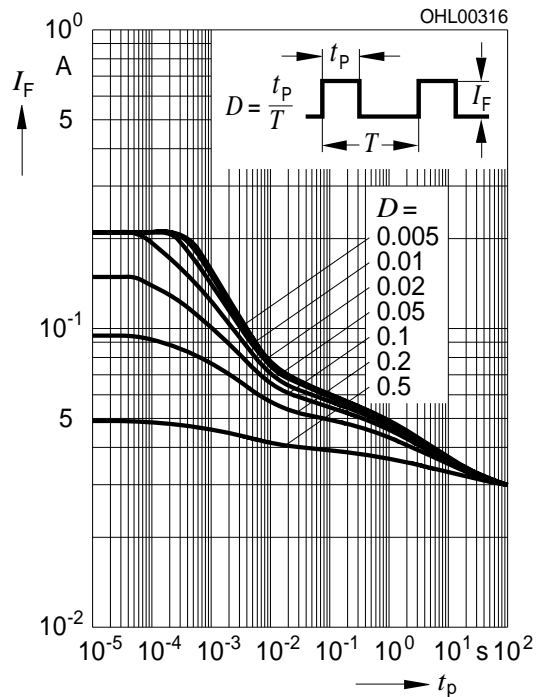

Zulässige Impulsbelastbarkeit $I_F = f(t_p)$
Permissible Pulse Handling Capability
 Duty cycle $D =$ parameter, $T_A = 85\text{ °C}$
LS, LA, LO

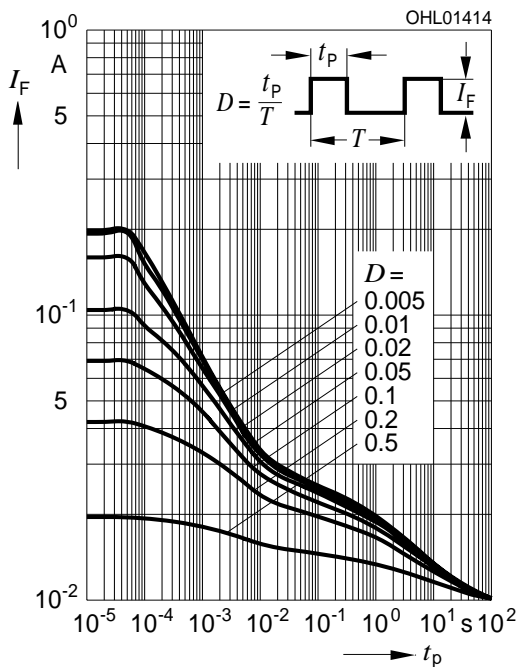

Zulässige Impulsbelastbarkeit $I_F = f(t_p)$
Permissible Pulse Handling Capability
 Duty cycle $D =$ parameter, $T_A = 85\text{ °C}$
LY

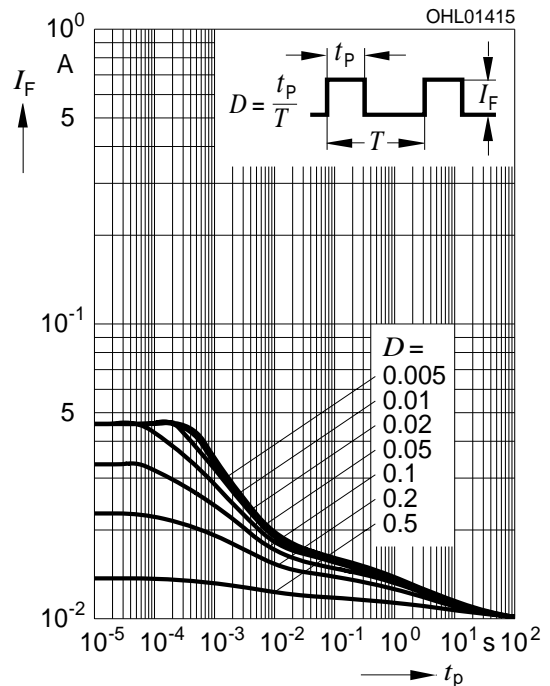

Maßzeichnung
Package Outlines

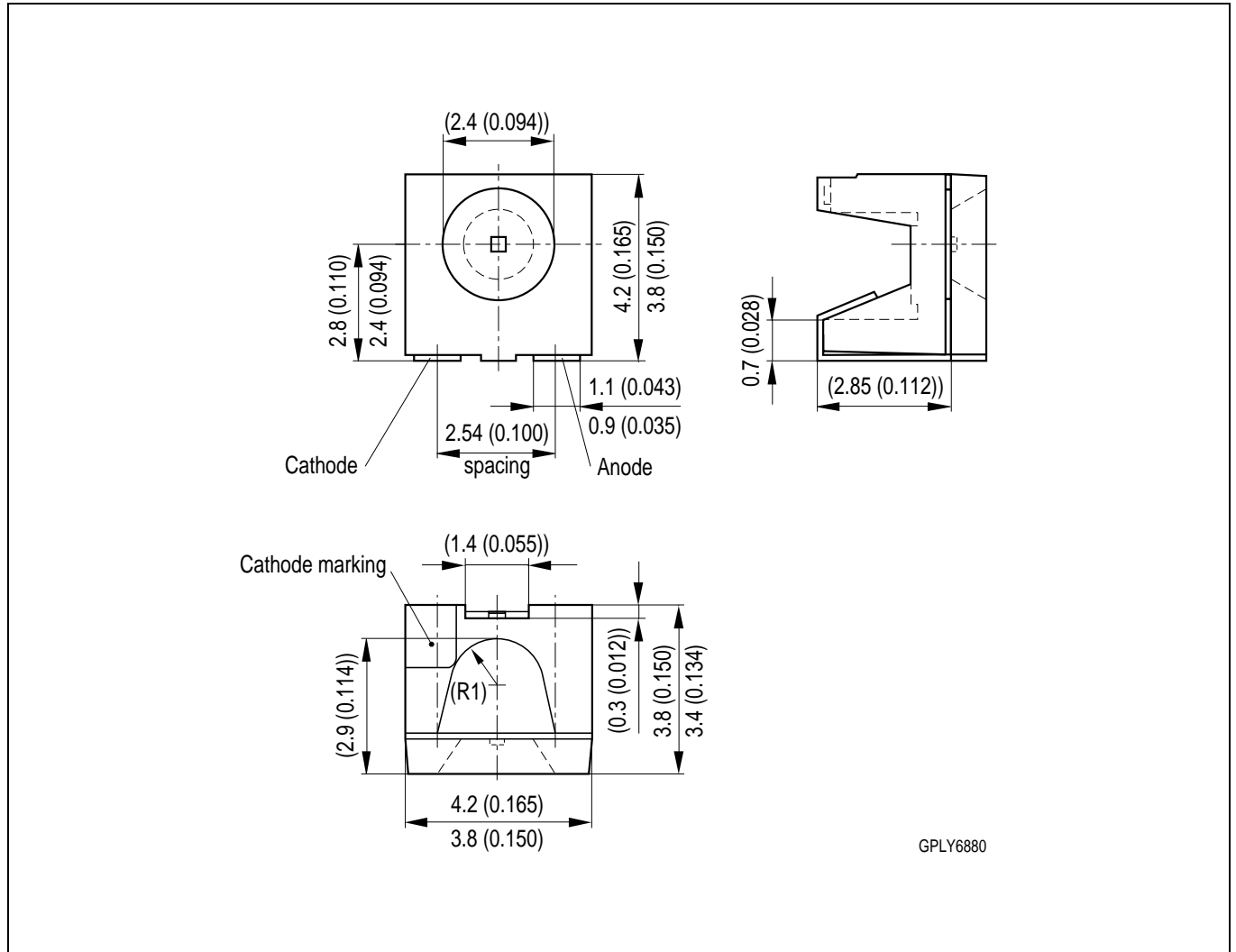

Maße werden wie folgt angegeben: mm (inch) / Dimensions are specified as follows: mm (inch).

Kathodenkennung: abgeschrägte Ecke
Cathode mark: bevelled edge
Gewicht / Approx. weight: 40 mg

Lötbedingungen Vorbehandlung nach JEDEC Level 2
Soldering Conditions Preconditioning acc. to JEDEC Level 2

IR-Reflow Lötprofil (nach IPC 9501)
IR Reflow Soldering Profile (acc. to IPC 9501)

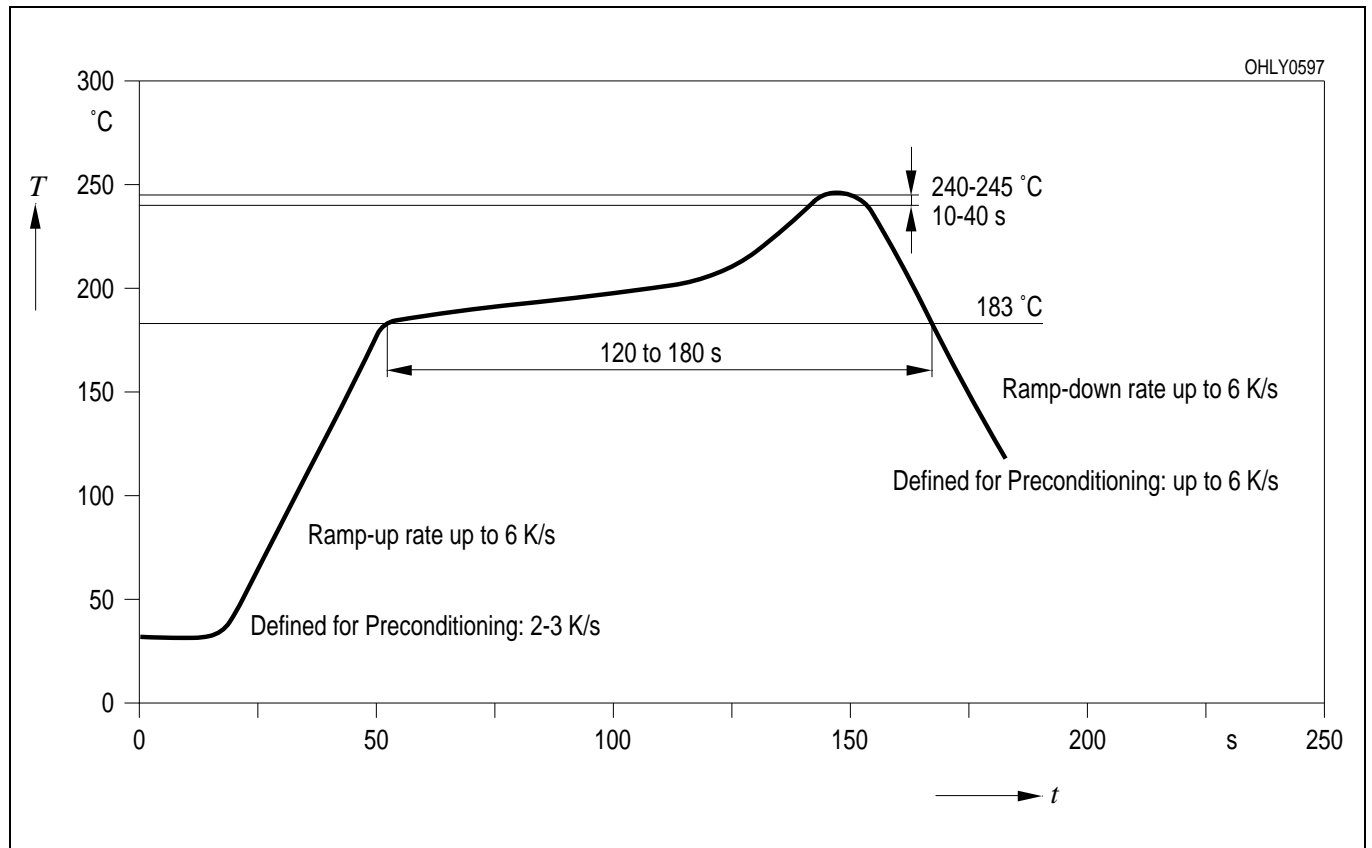

Wellenlöten (TTW) (nach CECC 00802)
TTW Soldering (acc. to CECC 00802)

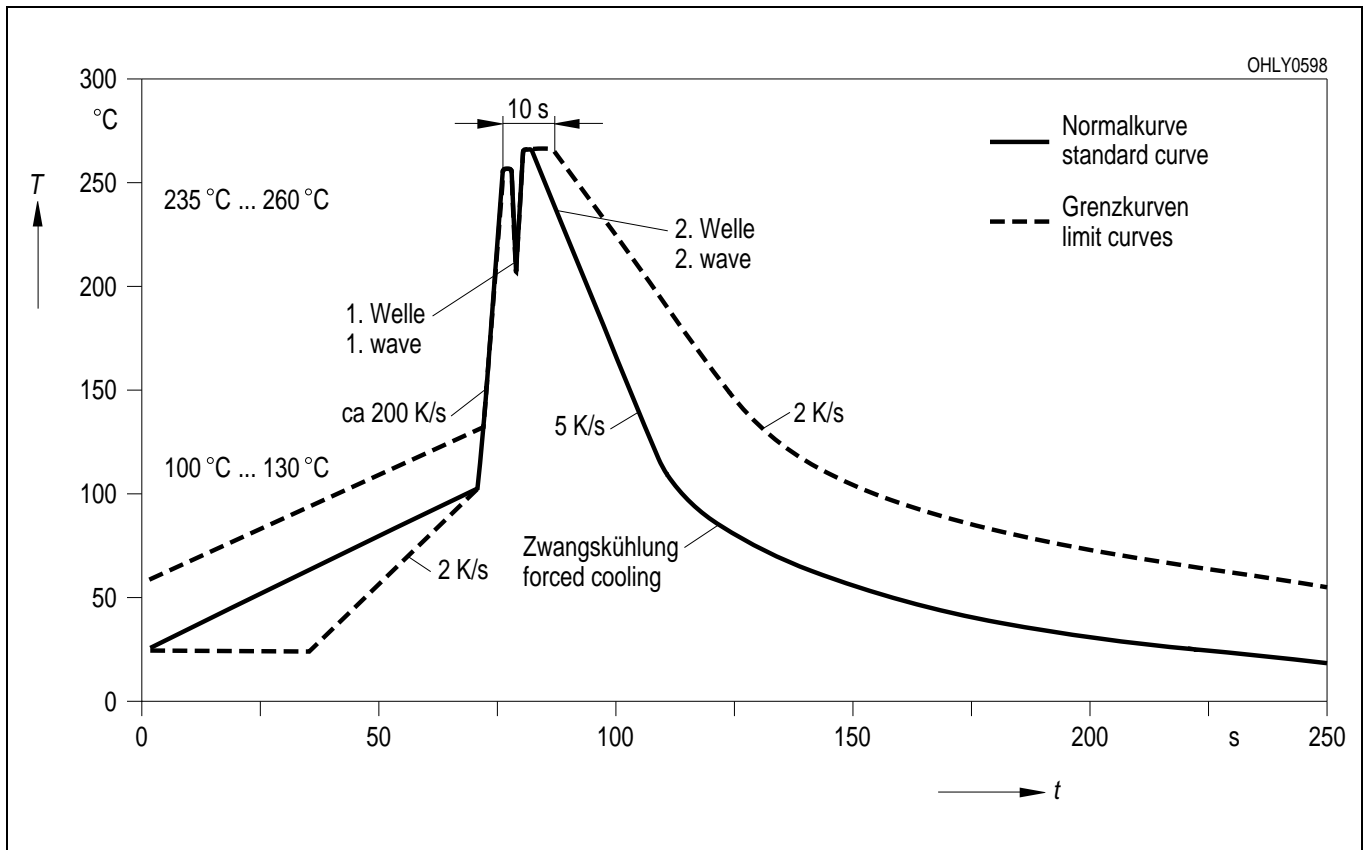

Empfohlenes Lötpad Design Wellenlöten (TTW)
Recommended Solder Pad TTW Soldering

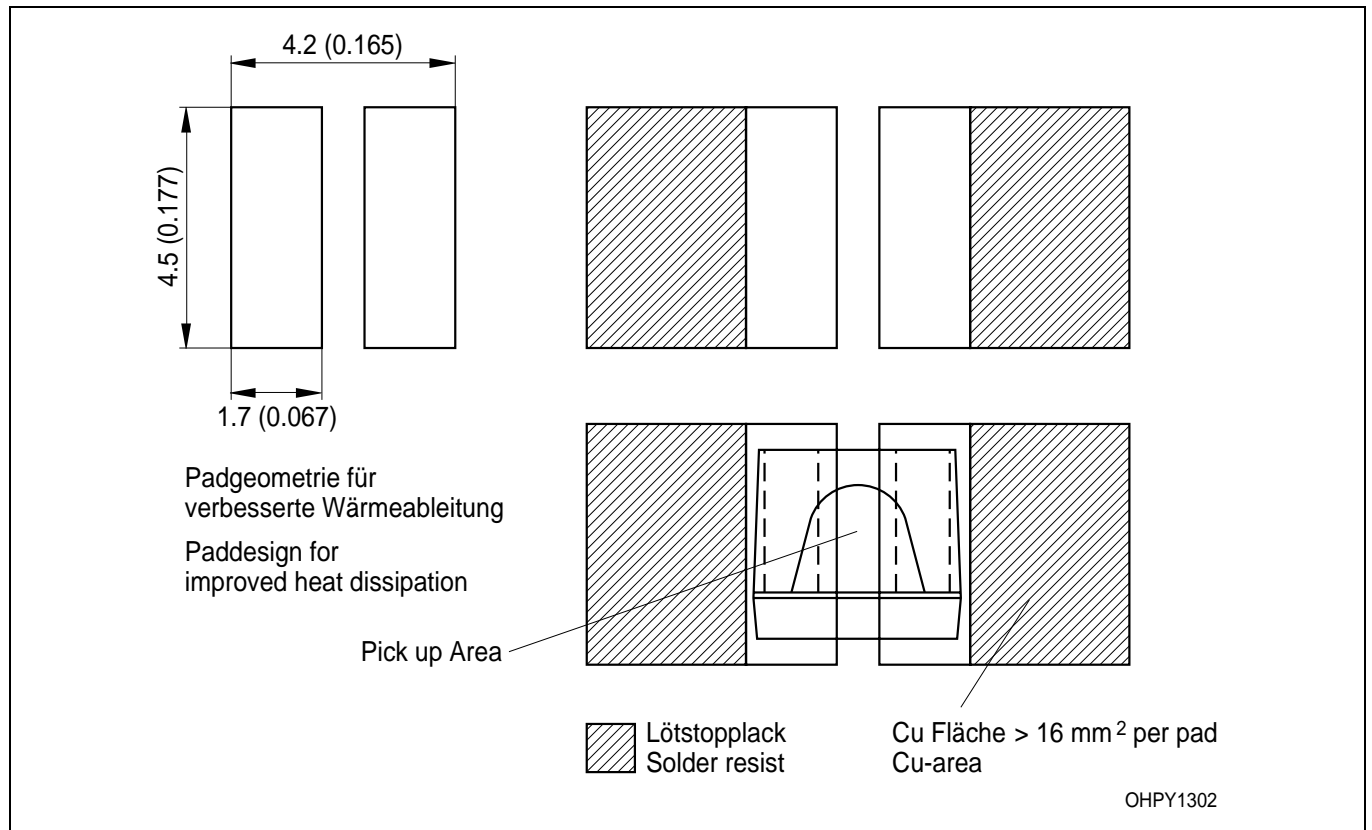

Maße werden wie folgt angegeben: mm (inch) / Dimensions are specified as follows: mm (inch)

Empfohlenes Lötpaddesign IR Reflow Lötén
Recommended Solder Pad IR Reflow Soldering

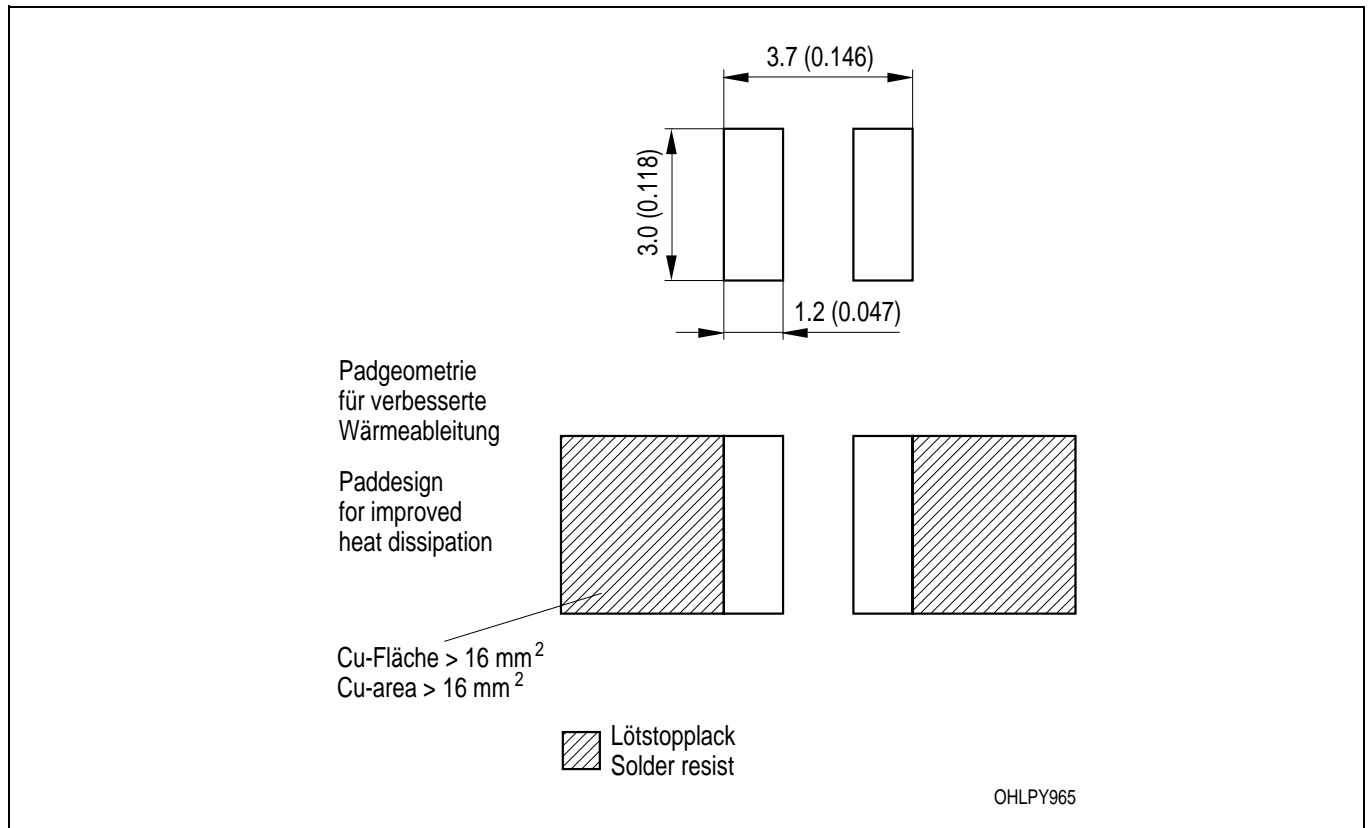

Maße werden wie folgt angegeben: mm (inch) / Dimensions are specified as follows: mm (inch).

Gurtung / Polarität und Lage Verpackungseinheit 2000/Rolle, ø330 mm
Method of Taping / Polarity and Orientation Packing unit 2000/reel, ø330 mm

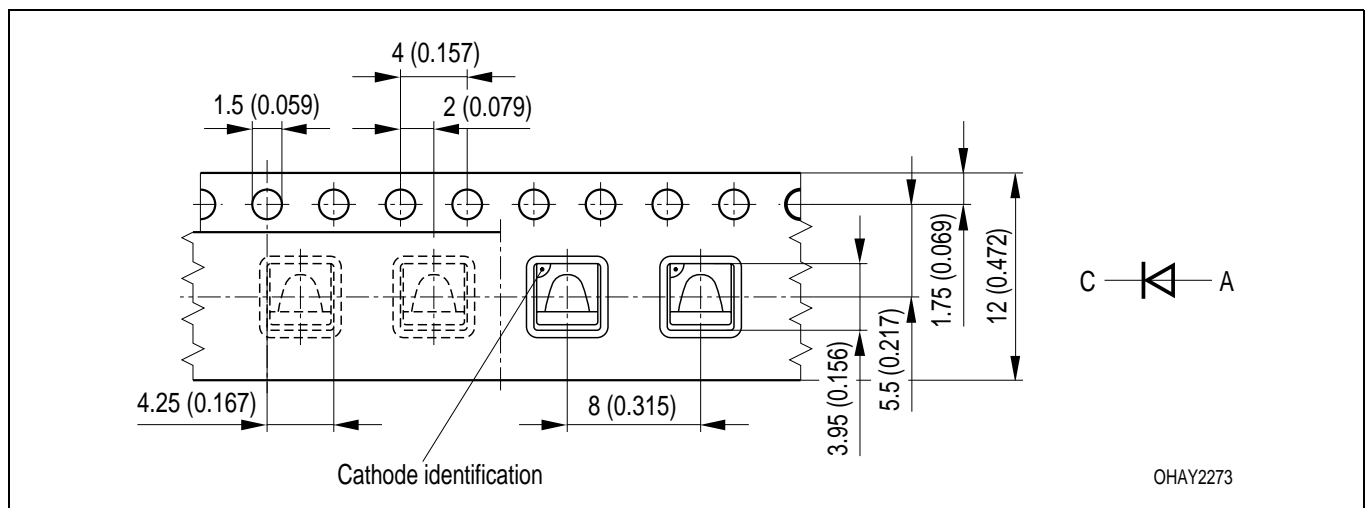

Maße werden wie folgt angegeben: mm (inch) / Dimensions are specified as follows: mm (inch)

Revision History: 2002-09-18		Date of change
Previous Version: 2002-08-19		
Page	Subjects (major changes since last revision)	
12	recommended solder pad (TTW soldering)	
4	value (wavelength amber/yellow	
5	wavelength groups	
2	wavelength grouping for yellow and orange	
14	annotations	2002-07-25
4	value ($TC_{\lambda_{dom}}$ from 0.04 to 0.05 nm/K)	2002-07-25
13	recommended solder pad (IR reflow soldering)	2002-08-01
3, 4	value (reverse voltage from 3 V to 12 V)	2002-09-18

Published by OSRAM Opto Semiconductors GmbH
Wernerwerkstrasse 2, D-93049 Regensburg

© All Rights Reserved.

Attention please!

The information describes the type of component and shall not be considered as assured characteristics.

All typical data and graphs are basing on representative samples, but don't represent the production range. If requested, e.g. because of technical improvements, these typ. data will be changed without any further notice.

Terms of delivery and rights to change design reserved. Due to technical requirements components may contain dangerous substances. For information on the types in question please contact our Sales Organization.

If printed or downloaded, please find the latest version in the Internet.

Packing

Please use the recycling operators known to you. We can also help you – get in touch with your nearest sales office. By agreement we will take packing material back, if it is sorted. You must bear the costs of transport. For packing material that is returned to us unsorted or which we are not obliged to accept, we shall have to invoice you for any costs incurred.

Components used in life-support devices or systems must be expressly authorized for such purpose! Critical components ¹ may only be used in life-support devices or systems ² with the express written approval of OSRAM OS.

¹ A critical component is a component used in a life-support device or system whose failure can reasonably be expected to cause the failure of that life-support device or system, or to affect its safety or the effectiveness of that device or system.

² Life support devices or systems are intended (a) to be implanted in the human body, or (b) to support and/or maintain and sustain human life. If they fail, it is reasonable to assume that the health of the user may be endangered.