

2012 Size

925/960 MHz
Chip Multilayer Coupler

FSLC-S090S-P

All the technical data and information contained herein are subject to change without notice.



LC-FSLC-S090S-P-0406A

Equivalent Circuits

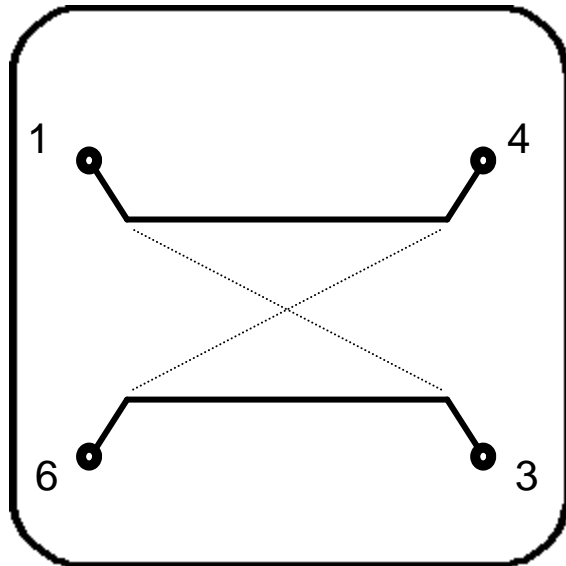

Shape & Size

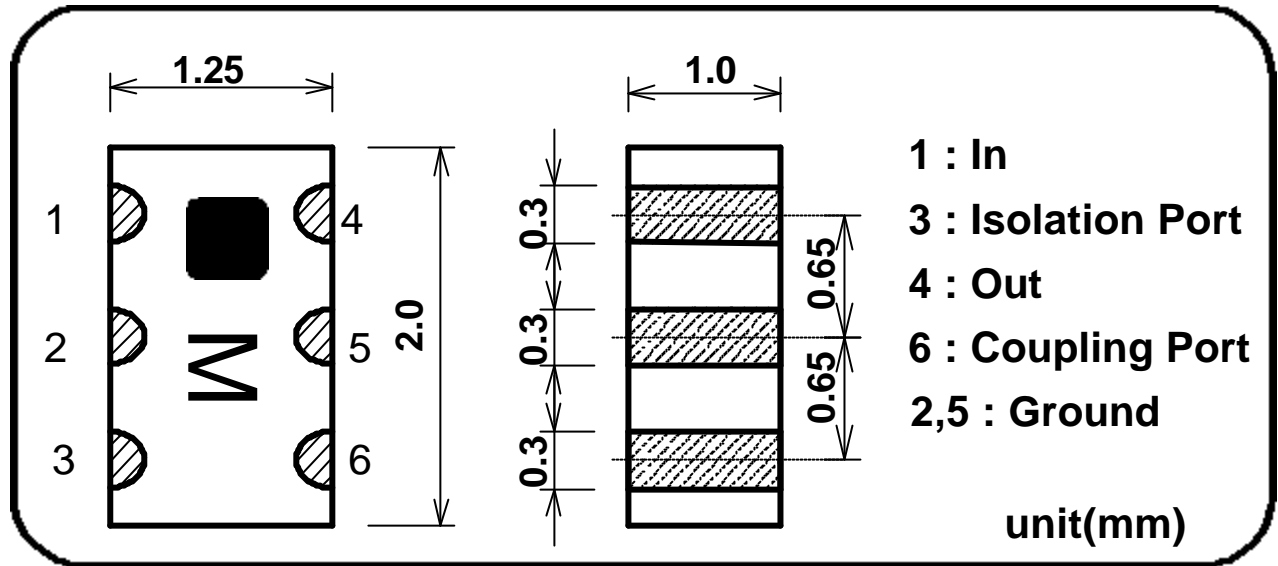

Specifications

Part Name: FSLC-S090S-P

Frequency Range	Coupling	Insertion Loss	Isolation	Return Loss	Handling Power	Temperature Range
925-960MHz	14.3 +/- 1dB	0.5dB Max. (0.25dB Typ.)	24dB Typ.	17dB Min. (22dB Typ.)	1W Max. (CW)	-35 to +85 deg.C

All the technical data and information contained herein are subject to change without notice.

LC-FSLC-S090S-P-0406A

FOOT PATTERN

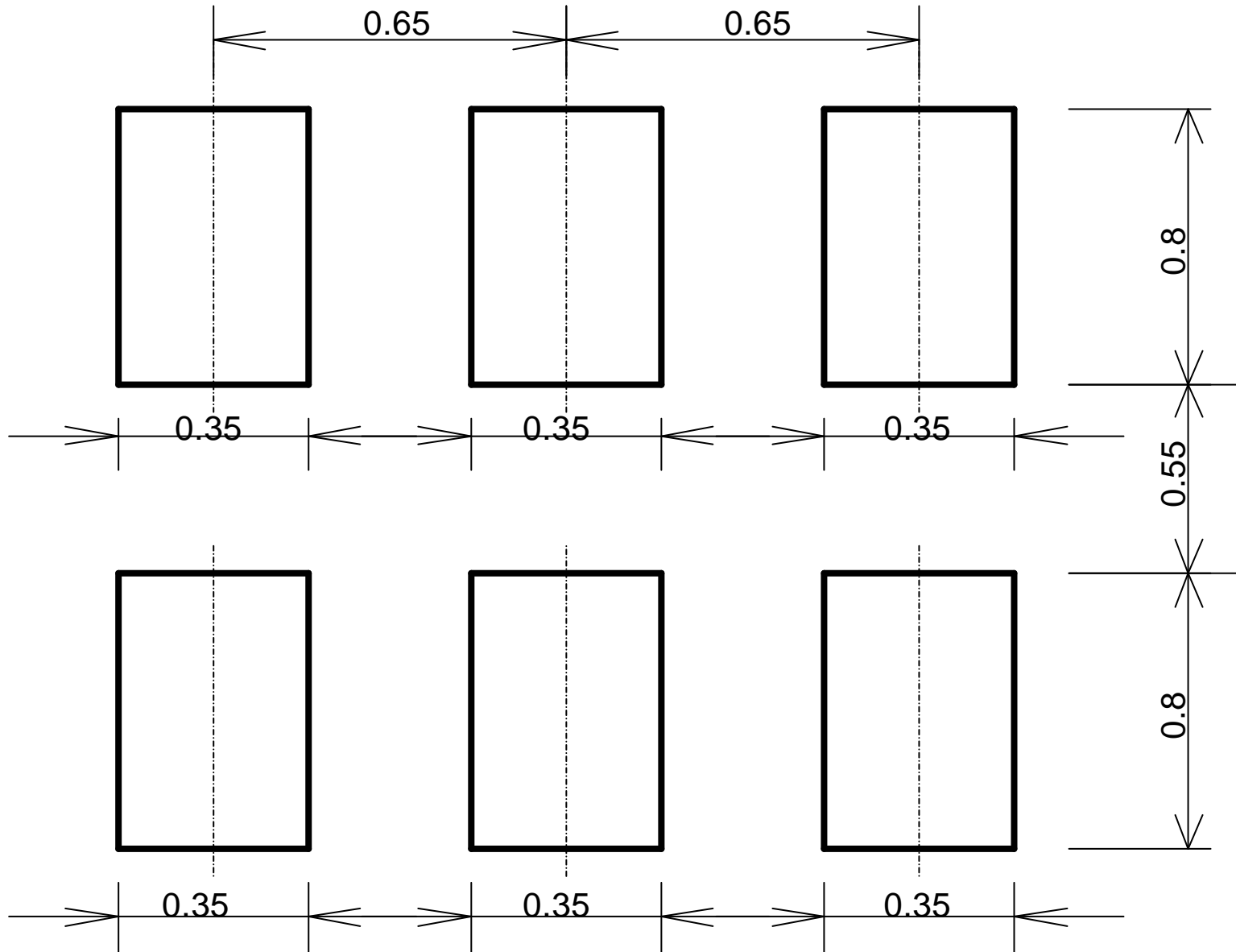

All the technical data and information contained herein are subject to change without notice.

LC-FSLC-S090S-P-0406A

FSLC-S090S-P Sample Data

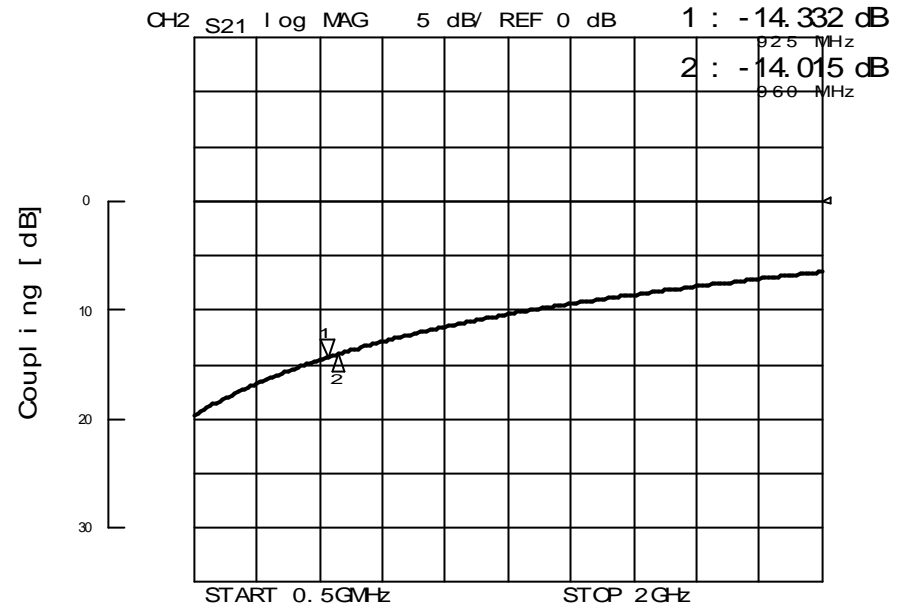
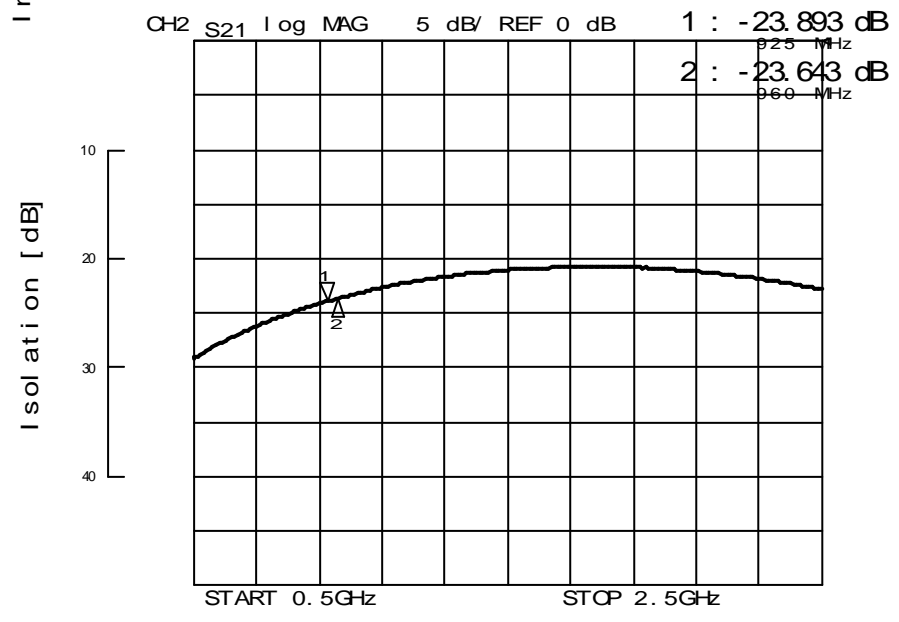
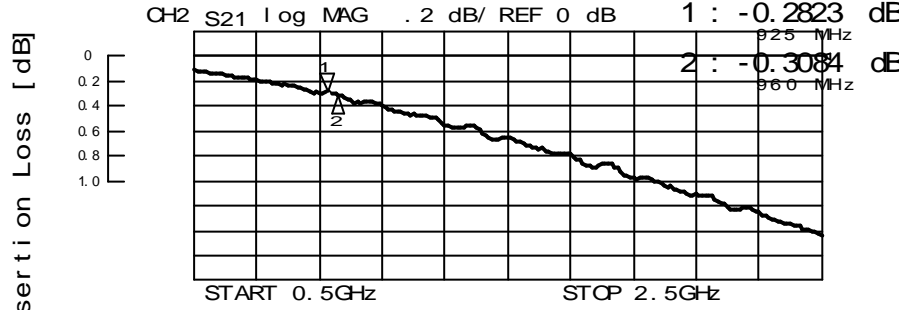
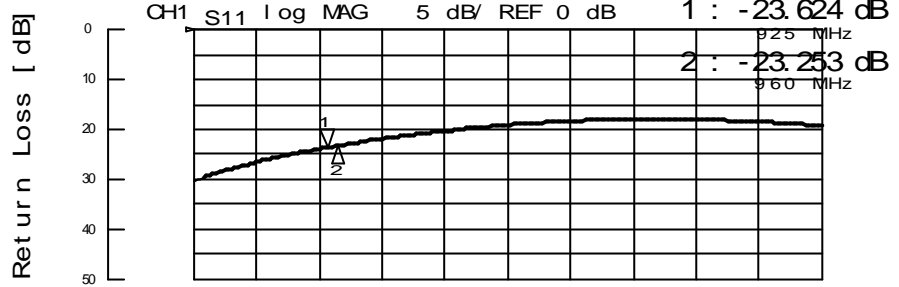

925/960 MHz
Chip Multilayer Coupler "FSLC-S090S-P"

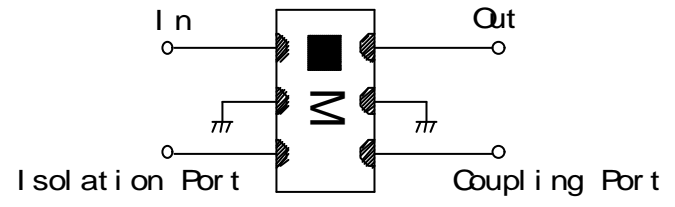

LC-FSLC-S090S-P-0406A