

FIBER OPTIC TRANSMITTING MODULE
FOR DIGITAL AUDIO EQUIPMENT

Features

- TTL interface.
- LED is driven by differential circuit.

Outline Dimensions (Unit:mm)

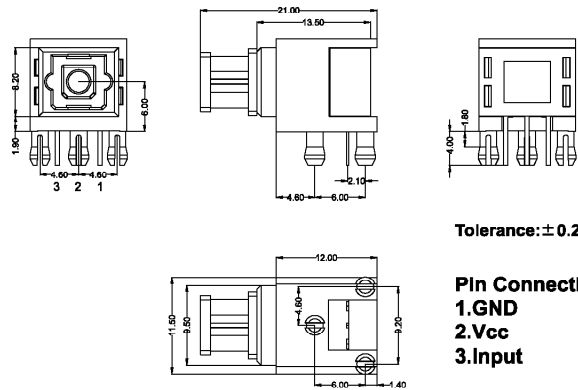

Tolerance: ±0.2mm

Pin Connection
1.GND
2.Vcc
3.Input

Applications

- Audio equipment.
- DVD player.
- Automobile.

1. Maximum Ratings (Ta=25°C)

Parameter	Symbol	Rating	Unit
Storage Temperature	T _{stg}	-40~80	°C
Operating Temperature	T _{opr}	-20~70	°C
Power Dissipation	P _{max}	120	mW
Supply Voltage	V _{cc}	-0.5~7	V
Input Voltage	V _{IN}	-0.5~V _{cc} +0.5	V
Soldering Temperature	T _{sol}	260 (Note 1)	°C

Note 1 : Soldering time ≦ 10 seconds (At a distance of 1 mm from the package.)

2. Recommended Operating Conditions

Parameter	Symbol	Min	Typ.	Max	Unit
Supply Voltage	V _{CC}	4.75	5.0	5.25	V
High-Level Input Voltage	V _{IH}	2.0	-	V _{CC}	V
Low-Level Input Voltage	V _{IL}	0	-	0.8	V

3. Electrical and Optical Characteristics (Ta=25°C, Vcc=5V)

Parameter	Symbol	Condition	Min	Typ.	Max	Unit
Data Rate		NRZ Signal (Note 2)	DC	-	13.2	Mb/s
Transmission Distance		Using APF (Note 3)	0.2	-	5	m
Fiber Output Power (Note 4)	Pf		-21	-	-15	dBm
Peak Emission Wavelength	λp		630	650	690	nm
Current Consumption	Icc		-	-	13	mA
High Level Input Voltage	V _{IH}		2.0	-	-	V
Low Level Input Voltage	V _{IL}		-	-	0.8	V
Low->High Propagation delay time	t _{PLH}				150	ns
High -> Low Propagation delay time	t _{PHL}				150	ns
Pulse Width Distortion	Δtw	6Mbps NRZ Signal	-25	-	25	ns
Jitter Time	Δtj				25	ns

Note 2 : LED is on when input signal is high, and off when it is low.

The duty factor must be maintained between 25 to 75%.

Note 3 : All Plastic Fiber (970 / 1000nm.)

Note 4 : Measure with a standard optical fiber, peak value.

4. Measuring method

(1).Measuring method of optical output coupling fiber

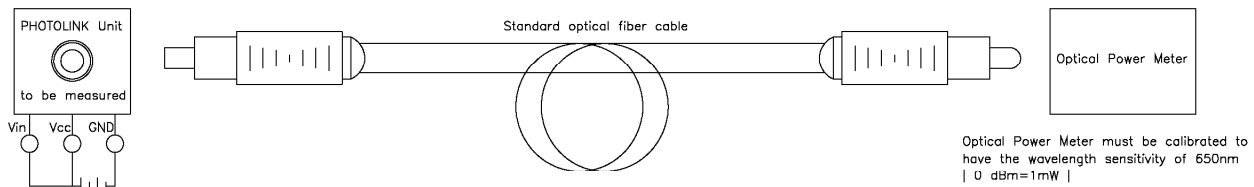

(2).Measuring method of power dissipation current and input voltage

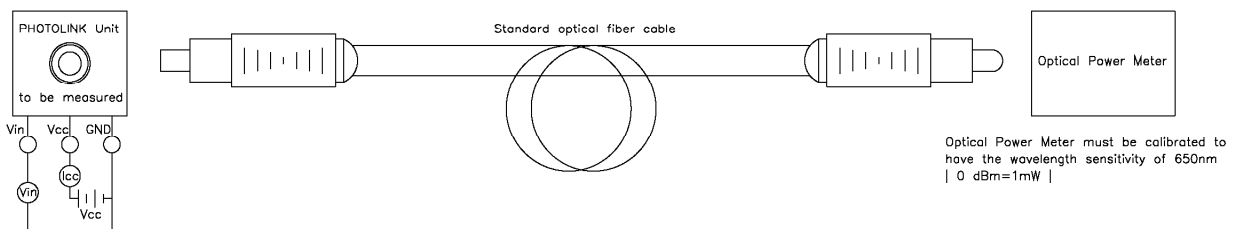

(3).Measuring method of Pulse response

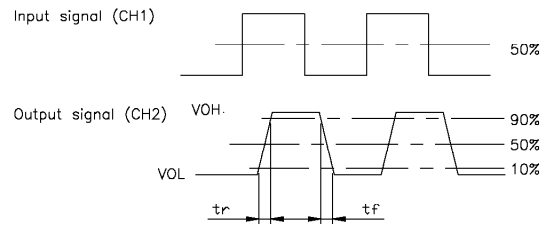
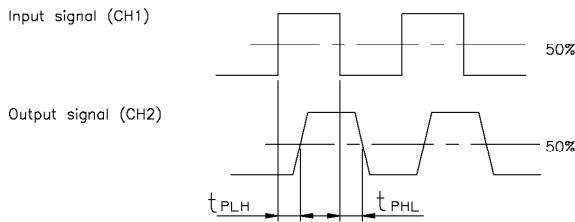
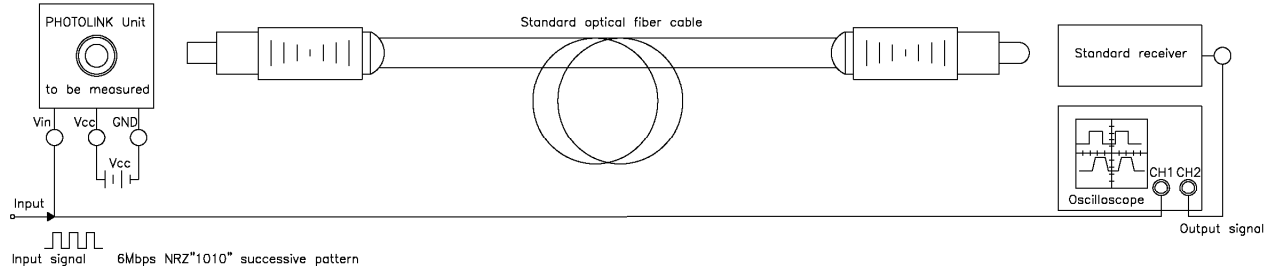

(4).Measuring method of Jitter

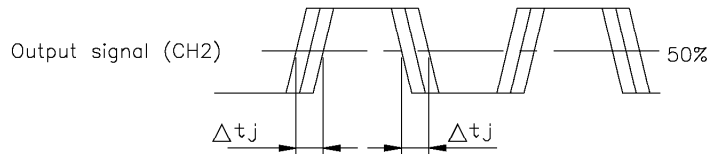
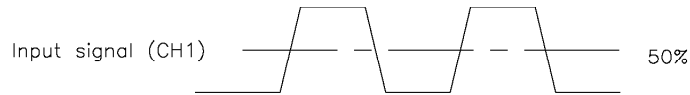
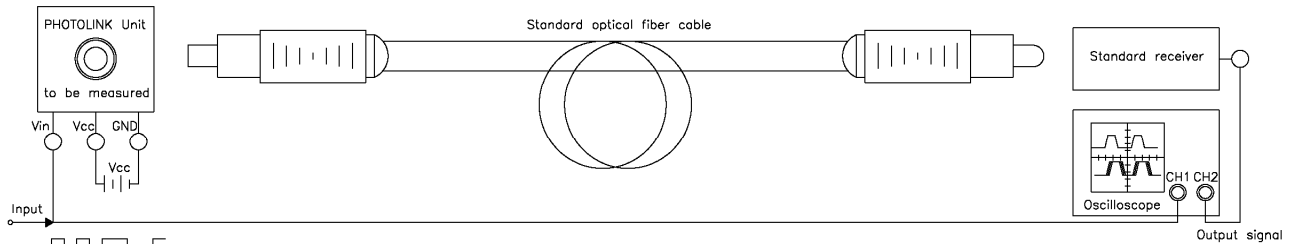

5.Recommended PCB Layout

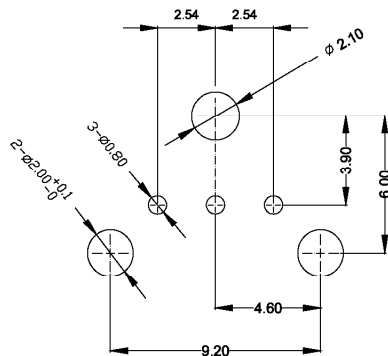

Notes:
1.Unit:mm
2.Tolerance: $\pm 0.3mm$