

International  
**IR** Rectifier  
**RADIATION HARDENED**  
**POWER MOSFET**  
**SURFACE MOUNT (LCC-18)**

PD - 94239E

**IRHE57034**  
**JANSR2N7495U5**  
**60V, N-CHANNEL**  
**REF: MIL-PRF-19500/700**



**Product Summary**

Part Number	Radiation Level	RDS(on)	ID	QPL Part Number
IRHE57034	100K Rads (Si)	0.08Ω	11.7A	JANSR2N7495U5
IRHE53034	300K Rads (Si)	0.08Ω	11.7A	JANSF2N7495U5
IRHE54034	500K Rads (Si)	0.08Ω	11.7A	JANSG2N7495U5
IRHE58034	1000K Rads (Si)	0.1Ω	11.7A	JANSH2N7495U5



International Rectifier's R5™ technology provides high performance power MOSFETs for space applications. These devices have been characterized for Single Event Effects (SEE) with useful performance up to an LET of 80 (MeV/(mg/cm<sup>2</sup>)). The combination of low RDS(on) and low gate charge reduces the power losses in switching applications such as DC to DC converters and motor control. These devices retain all of the well established advantages of MOSFETs such as voltage control, fast switching, ease of paralleling and temperature stability of electrical parameters.

**Features:**

- Single Event Effect (SEE) Hardened
- Ultra Low RDS(on)
- Low Total Gate Charge
- Simple Drive Requirements
- Ease of Paralleling
- Hermetically Sealed
- Surface Mount
- Ceramic Package
- Light Weight

**Absolute Maximum Ratings**

**Pre-Irradiation**

	Parameter		Units
ID @ VGS = 12V, TC = 25°C	Continuous Drain Current	11.7	A
ID @ VGS = 12V, TC = 100°C	Continuous Drain Current	7.4	
IDM	Pulsed Drain Current ①	46.8	
PD @ TC = 25°C	Max. Power Dissipation	25	W
	Linear Derating Factor	0.2	W/°C
VGS	Gate-to-Source Voltage	±20	V
EAS	Single Pulse Avalanche Energy ②	87	mJ
IAR	Avalanche Current ①	11.7	A
EAR	Repetitive Avalanche Energy ①	2.5	mJ
dv/dt	Peak Diode Recovery dv/dt ③	3.4	V/ns
TJ	Operating Junction	-55 to 150	°C
TSTG	Storage Temperature Range		
	Pckg. Mounting Surface Temp.	300 (for 5s)	
	Weight	0.42 (Typical)	g

For footnotes refer to the last page

www.irf.com

**Electrical Characteristics @ T<sub>j</sub> = 25°C (Unless Otherwise Specified)**

	Parameter	Min	Typ	Max	Units	Test Conditions
BVDSS	Drain-to-Source Breakdown Voltage	60	—	—	V	V <sub>GS</sub> = 0V, I <sub>D</sub> = 1.0mA
ΔBVDSS/ΔT <sub>J</sub>	Temperature Coefficient of Breakdown Voltage	—	0.058	—	V/°C	Reference to 25°C, I <sub>D</sub> = 1.0mA
RDS(on)	Static Drain-to-Source On-State Resistance	—	—	0.08	Ω	V <sub>GS</sub> = 12V, I <sub>D</sub> = 7.4A ④
VGS(th)	Gate Threshold Voltage	2.0	—	4.0	V	V <sub>DS</sub> = V <sub>GS</sub> , I <sub>D</sub> = 1.0mA
gfs	Forward Transconductance	7.0	—	—	S (r)	V <sub>DS</sub> ≥ 15V, I <sub>DS</sub> = 7.4A ④
I <sub>DSS</sub>	Zero Gate Voltage Drain Current	—	—	10	μA	V <sub>DS</sub> = 48V, V <sub>GS</sub> = 0V
		—	—	25		V <sub>DS</sub> = 48V, V <sub>GS</sub> = 0V, T <sub>J</sub> = 125°C
I <sub>GSS</sub>	Gate-to-Source Leakage Forward	—	—	100	nA	V <sub>GS</sub> = 20V
I <sub>GSS</sub>	Gate-to-Source Leakage Reverse	—	—	-100		V <sub>GS</sub> = -20V
Q <sub>g</sub>	Total Gate Charge	—	—	45	nC	V <sub>GS</sub> = 12V, I <sub>D</sub> = 11.7A V <sub>DS</sub> = 30V
Q <sub>gs</sub>	Gate-to-Source Charge	—	—	15		
Q <sub>gd</sub>	Gate-to-Drain ('Miller') Charge	—	—	20		
t <sub>d(on)</sub>	Turn-On Delay Time	—	—	25	ns	V <sub>DD</sub> = 30V, I <sub>D</sub> = 11.7A, V <sub>GS</sub> = 12V, R <sub>G</sub> = 7.5Ω
t <sub>r</sub>	Rise Time	—	—	100		
t <sub>d(off)</sub>	Turn-Off Delay Time	—	—	35		
t <sub>f</sub>	Fall Time	—	—	30		
L <sub>S</sub> + L <sub>D</sub>	Total Inductance	—	6.1	—	nH	Measured from the center of drain pad to center of source pad
C <sub>iss</sub>	Input Capacitance	—	1250	—	pF	V <sub>GS</sub> = 0V, V <sub>DS</sub> = 25V f = 1.0MHz
C <sub>oss</sub>	Output Capacitance	—	520	—		
C <sub>rss</sub>	Reverse Transfer Capacitance	—	16	—		

**Source-Drain Diode Ratings and Characteristics**

	Parameter	Min	Typ	Max	Units	Test Conditions
I <sub>S</sub>	Continuous Source Current (Body Diode)	—	—	11.7	A	T <sub>J</sub> = 25°C, I <sub>S</sub> = 11.7A, V <sub>GS</sub> = 0V ④
I <sub>SM</sub>	Pulse Source Current (Body Diode) ①	—	—	46.8		
V <sub>SD</sub>	Diode Forward Voltage	—	—	1.8	V	T <sub>J</sub> = 25°C, I <sub>F</sub> = 11.7A, di/dt ≤ 100A/μs
t <sub>rr</sub>	Reverse Recovery Time	—	—	125	ns	V <sub>DD</sub> ≤ 25V ④
Q <sub>RR</sub>	Reverse Recovery Charge	—	—	420	nC	
t <sub>on</sub>	Forward Turn-On Time	Intrinsic turn-on time is negligible. Turn-on speed is substantially controlled by L <sub>S</sub> + L <sub>D</sub> .				

**Thermal Resistance**

	Parameter	Min	Typ	Max	Units	Test Conditions
R <sub>thJC</sub>	Junction-to-Case	—	—	5.0	°C/W	soldered to a copper-clad PC board
R <sub>thJ-PCB</sub>	Junction-to-PC board	—	19	—		
R <sub>thJA</sub>	Junction-to-Ambient	—	75	—		

**Note:** Corresponding Spice and Saber models are available on International Rectifier Web site.

For footnotes refer to the last page

## Radiation Characteristics

## IRHE57034, JANSR2N7495U5

International Rectifier Radiation Hardened MOSFETs are tested to verify their radiation hardness capability. The hardness assurance program at International Rectifier is comprised of two radiation environments. Every manufacturing lot is tested for total ionizing dose (per notes 5 and 6) using the TO-3 package. Both pre- and post-irradiation performance are tested and specified using the same drive circuitry and test conditions in order to provide a direct comparison.

**Table 1. Electrical Characteristics @ Tj = 25°C, Post Total Dose Irradiation** ⑤⑥

	Parameter	Up to 500K Rads(Si) <sup>1</sup>		1000K Rads (Si) <sup>2</sup>		Units	Test Conditions
		Min	Max	Min	Max		
BV <sub>DSS</sub>	Drain-to-Source Breakdown Voltage	60	—	60	—	V	V <sub>GS</sub> = 0V, I <sub>D</sub> = 1.0mA
V <sub>GS(th)</sub>	Gate Threshold Voltage	2.0	4.0	1.5	4.0		V <sub>GS</sub> = V <sub>DS</sub> , I <sub>D</sub> = 1.0mA
I <sub>GSS</sub>	Gate-to-Source Leakage Forward	—	100	—	100	nA	V <sub>GS</sub> = 20V
I <sub>GSS</sub>	Gate-to-Source Leakage Reverse	—	-100	—	-100		V <sub>GS</sub> = -20 V
I <sub>DSS</sub>	Zero Gate Voltage Drain Current	—	10	—	25	μA	V <sub>DS</sub> = 48V, V <sub>GS</sub> = 0V
R <sub>DS(on)</sub>	Static Drain-to-Source ④ On-State Resistance (TO-3)	—	0.034	—	0.043	Ω	V <sub>GS</sub> = 12V, I <sub>D</sub> = 7.4A
R <sub>DS(on)</sub>	Static Drain-to-Source ④ On-State Resistance (LCC-18)	—	0.08	—	0.1	Ω	V <sub>GS</sub> = 12V, I <sub>D</sub> = 7.4A
V <sub>SD</sub>	Diode Forward Voltage ④	—	1.8	—	1.8	V	V <sub>GS</sub> = 0V, I <sub>S</sub> = 11.7A

- Part numbers IRHE57064 (JANSR2N7495U5), IRHE53064 (JANSF2N7495U5) and IRHE54064 (JANSH2N7495U5)
- Part number IRHE58064 (JANSH2N7495U5)

International Rectifier radiation hardened MOSFETs have been characterized in heavy ion environment for Single Event Effects (SEE). Single Event Effects characterization is illustrated in Fig. a and Table 2.

**Table 2. Single Event Effect Safe Operating Area**

Ion	LET (MeV/(mg/cm <sup>2</sup> ))	Energy (MeV)	Range (μm)	V <sub>DS</sub> (V)				
				@V <sub>GS</sub> = 0V	@V <sub>GS</sub> = -5V	@V <sub>GS</sub> = -10V	@V <sub>GS</sub> = -15V	@V <sub>GS</sub> = -20V
Br	37.3	285	36.8	60	60	60	60	40
Xe	63	300	29	46	46	35	25	15
Au	86.6	2068	106	35	35	27	20	14

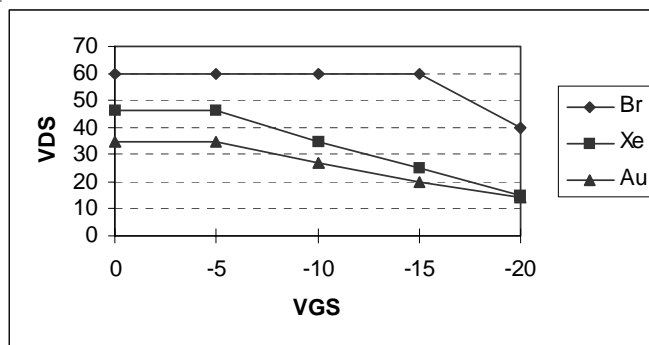

**Fig a. Single Event Effect, Safe Operating Area**

For footnotes refer to the last page

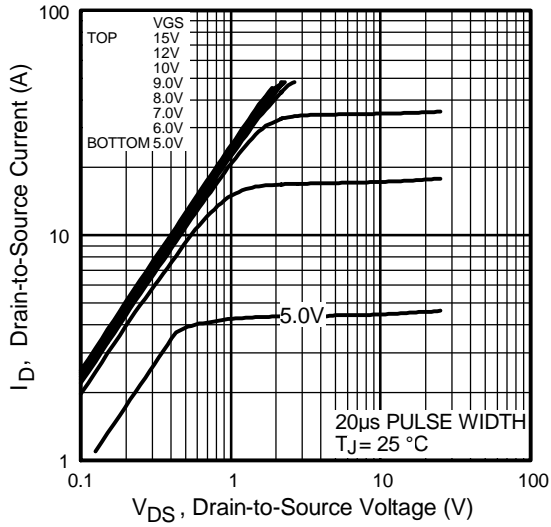

Fig 1. Typical Output Characteristics

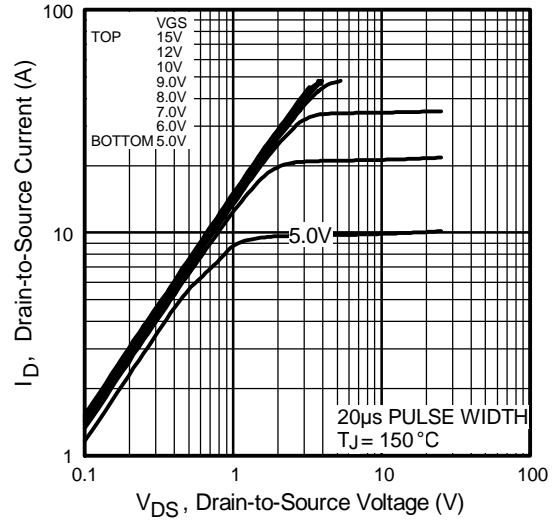

Fig 2. Typical Output Characteristics

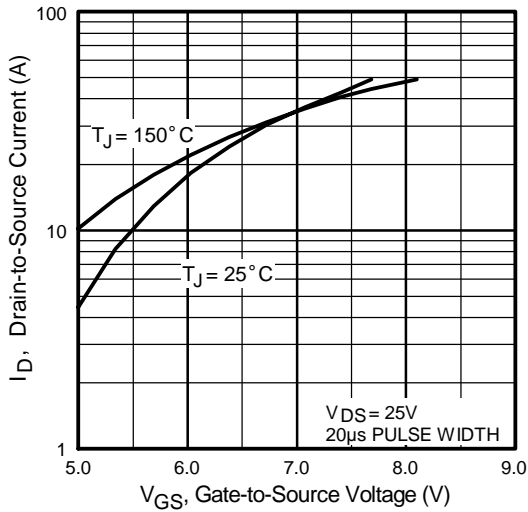

Fig 3. Typical Transfer Characteristics

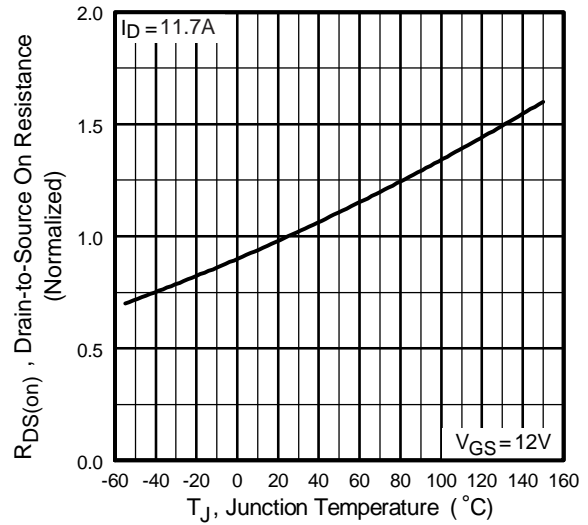
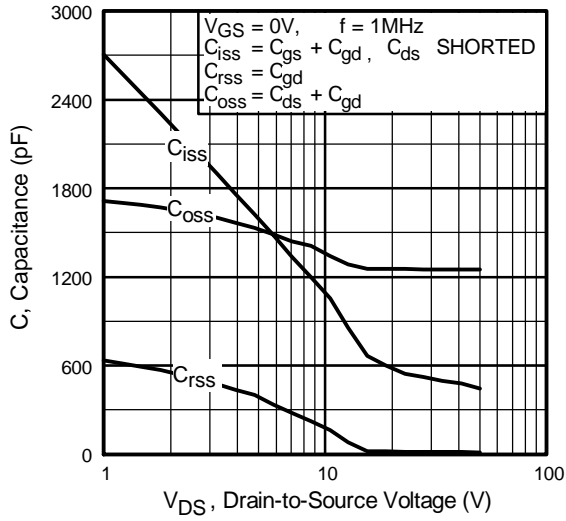
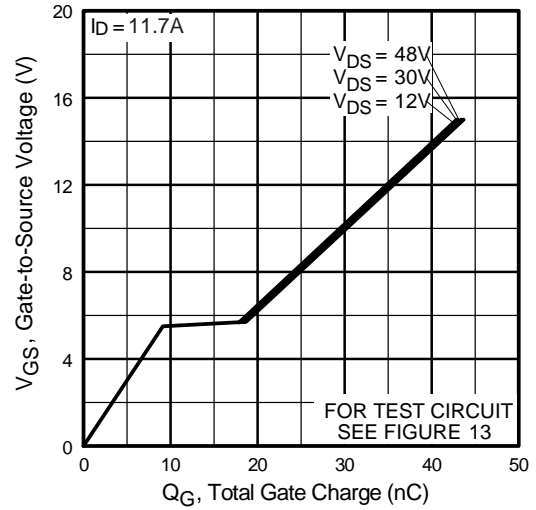

Fig 4. Normalized On-Resistance Vs. Temperature



**Fig 5.** Typical Capacitance Vs. Drain-to-Source Voltage



**Fig 6.** Typical Gate Charge Vs. Gate-to-Source Voltage

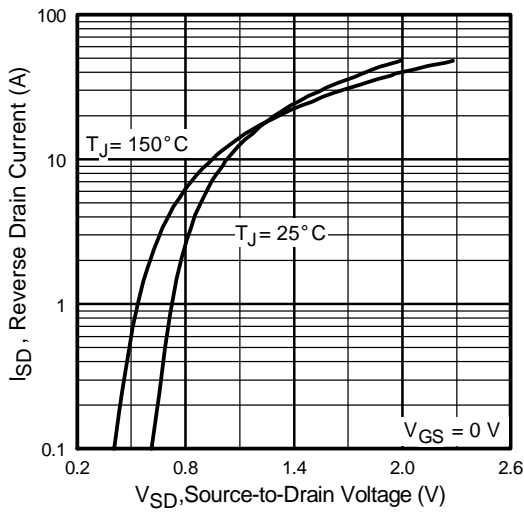

**Fig 7.** Typical Source-Drain Diode Forward Voltage

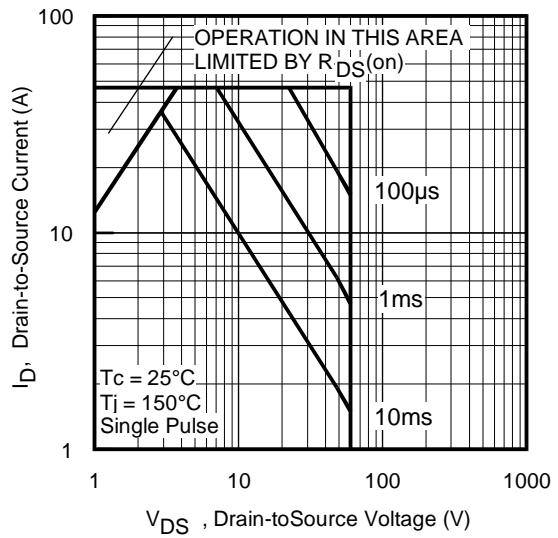

**Fig 8.** Maximum Safe Operating Area

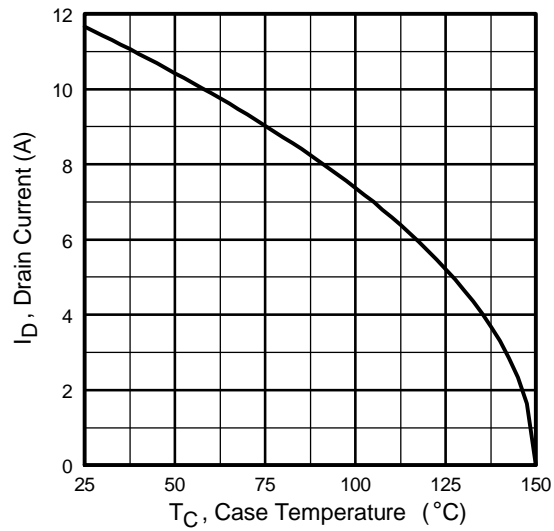

Fig 9. Maximum Drain Current Vs. Case Temperature

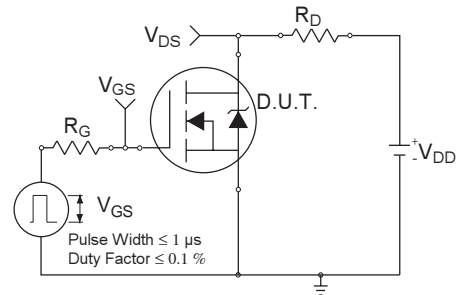

Fig 10a. Switching Time Test Circuit

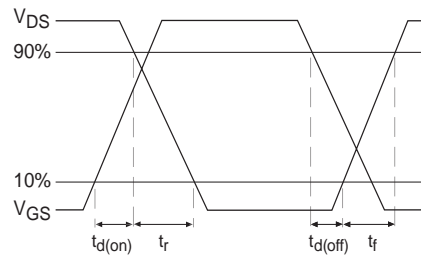

Fig 10b. Switching Time Waveforms

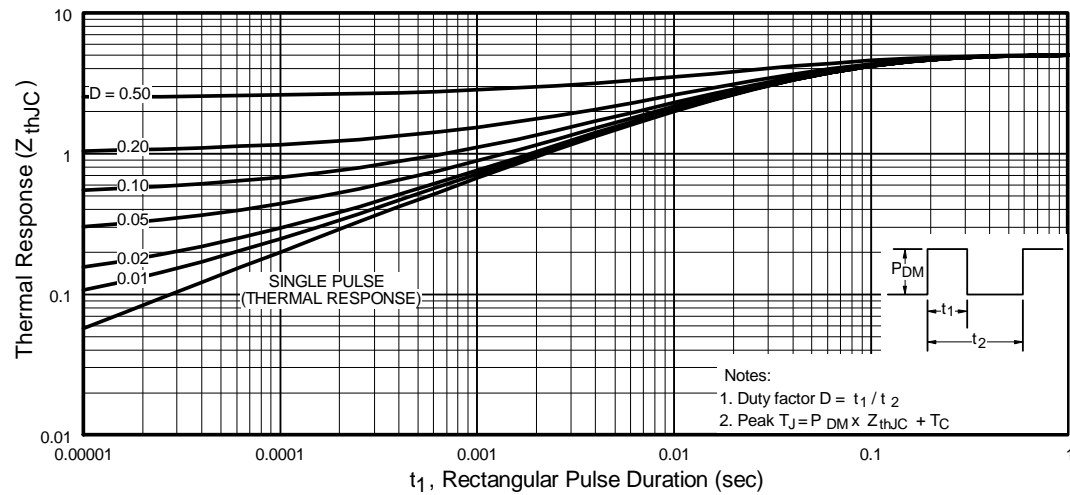

Fig 11. Maximum Effective Transient Thermal Impedance, Junction-to-Case

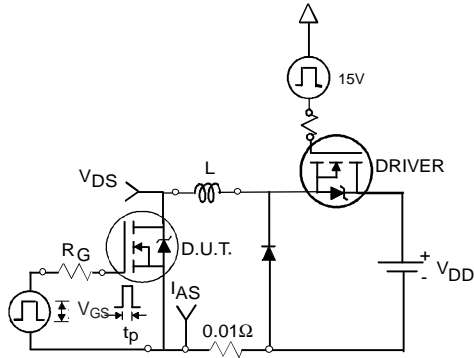

Fig 12a. Unclamped Inductive Test Circuit

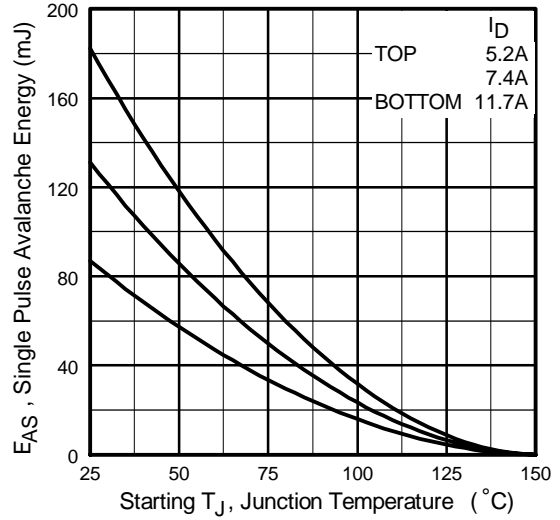

Fig 12c. Maximum Avalanche Energy Vs. Drain Current

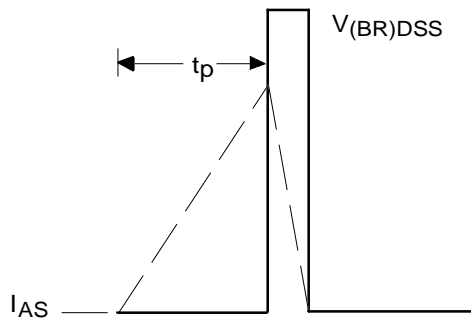

Fig 12b. Unclamped Inductive Waveforms

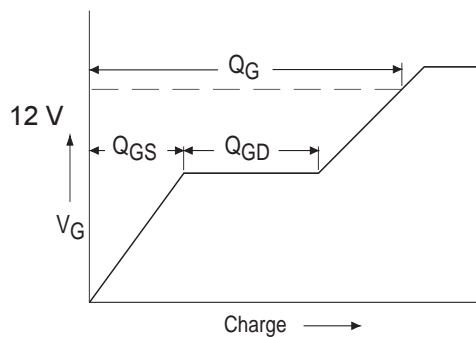

Fig 13a. Basic Gate Charge Waveform

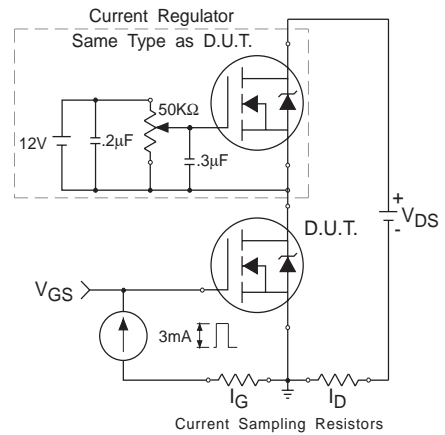
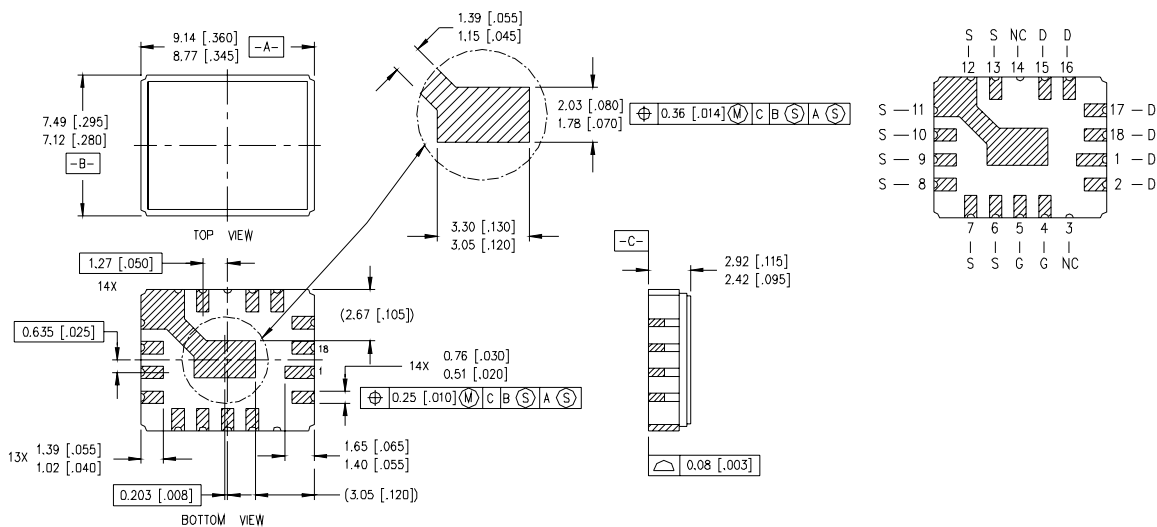

Fig 13b. Gate Charge Test Circuit

**Footnotes:**

- ① Repetitive Rating; Pulse width limited by maximum junction temperature.
- ②  $V_{DD} = 25V$ , starting  $T_J = 25^\circ C$ ,  $L = 1.27mH$   
Peak  $I_L = 11.7A$ ,  $V_{GS} = 12V$
- ③  $ISD \leq 11.7A$ ,  $di/dt \leq 220A/\mu s$ ,  
 $V_{DD} \leq 60V$ ,  $T_J \leq 150^\circ C$
- ④ Pulse width  $\leq 300 \mu s$ ; Duty Cycle  $\leq 2\%$
- ⑤ **Total Dose Irradiation with  $V_{GS}$  Bias.**  
12 volt  $V_{GS}$  applied and  $V_{DS} = 0$  during irradiation per MIL-STD-750, method 1019, condition A.
- ⑥ **Total Dose Irradiation with  $V_{DS}$  Bias.**  
48 volt  $V_{DS}$  applied and  $V_{GS} = 0$  during irradiation per MIL-STD-750, method 1019, condition A.

**Case Outline and Dimensions — LCC-18**



- NOTES:**
- DIMENSIONING & TOLERANCING PER ANSI Y14.5M-1982.
  - CONTROLLING DIMENSION: INCH.
  - DIMENSIONS ARE SHOWN IN MILLIMETERS [INCHES].

- PAD ASSIGNMENTS**
- G = GATE
  - D = DRAIN
  - S = SOURCE
  - NC = NO CONNECTION



**IR WORLD HEADQUARTERS:** 233 Kansas St., El Segundo, California 90245, USA Tel: (310) 252-7105  
**IR LEOMINSTER :** 205 Crawford St., Leominster, Massachusetts 01453, USA Tel: (978) 534-5776  
 TAC Fax: (310) 252-7903

Visit us at [www.irf.com](http://www.irf.com) for sales contact information.  
 Data and specifications subject to change without notice. 04/2006