

Preliminary data

HiPerFAST™ IGBT with Diode

IXGX50N60AU1 IXGX50N60AU1S

$V_{CES} = 600 \text{ V}$
 $I_{C25} = 75 \text{ A}$
 $V_{CE(sat)} = 2.7 \text{ V}$
 $t_{fi} = 275 \text{ ns}$

Combi Pack

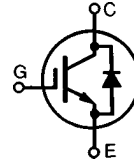

TO-247 Hole-less SMD
(50N60AU1S)

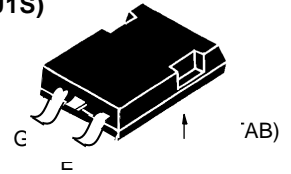

TO-247 Hole-less
(50N60AU1)

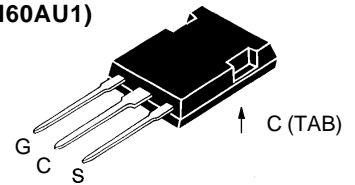

G = Gate, C = Collector,
E = Emitter, TAB = Collector

Symbol	Test Conditions	Maximum Ratings	
V_{CES}	$T_J = 25^\circ\text{C}$ to 150°C	600	V
V_{CGR}	$T_J = 25^\circ\text{C}$ to 150°C ; $R_{GE} = 1 \text{ M}\Omega$	600	V
V_{GES}	Continuous	± 20	V
V_{GEM}	Transient	± 30	V
I_{C25}	$T_C = 25^\circ\text{C}$, limited by leads	75	A
I_{C90}	$T_C = 90^\circ\text{C}$	50	A
I_{CM}	$T_C = 25^\circ\text{C}$, 1 ms	200	A
SSOA (RBSOA)	$V_{GE} = 15 \text{ V}$, $T_{VJ} = 125^\circ\text{C}$, $R_G = 10 \Omega$ Clamped inductive load, $L = 30 \mu\text{H}$	$I_{CM} = 100$ @ $0.8 V_{CES}$	A
P_C	$T_C = 25^\circ\text{C}$	300	W
T_J		-55 ... +150	$^\circ\text{C}$
T_{JM}		150	$^\circ\text{C}$
T_{stg}		-55 ... +150	$^\circ\text{C}$
Weight		6	g
Maximum lead temperature for soldering 1.6 mm (0.062 in.) from case for 10 s		300	$^\circ\text{C}$

Features

- Hole-less TO-247 for clip mount
- High current capability
- High frequency IGBT and anti-parallel FRED in one package
- Low $V_{CE(sat)}$
 - for minimum on-state conduction losses
- MOS Gate turn-on
 - drive simplicity
- Fast Recovery Epitaxial Diode (FRED)
 - soft recovery with low I_{RM}

Applications

- AC motor speed control
- DC servo and robot drives
- DC choppers
- Uninterruptible power supplies (UPS)
- Switch-mode and resonant-mode power supplies

Advantages

- Space savings (two devices in one package)
- Reduces assembly time and cost
- High power density

Symbol	Test Conditions	Characteristic Values ($T_J = 25^\circ\text{C}$, unless otherwise specified)		
		min.	typ.	max.
BV_{CES}	$I_C = 500 \mu\text{A}$, $V_{GE} = 0 \text{ V}$	600		V
$V_{GE(th)}$	$I_C = 500 \mu\text{A}$, $V_{CE} = V_{GE}$	2.5	5.5	V
I_{CES}	$V_{CE} = 0.8 \cdot V_{CES}$ $V_{GE} = 0 \text{ V}$		$T_J = 25^\circ\text{C}$ $T_J = 125^\circ\text{C}$	250 μA 15 mA
I_{GES}	$V_{CE} = 0 \text{ V}$, $V_{GE} = \pm 20 \text{ V}$			$\pm 100 \text{ nA}$
$V_{CE(sat)}$	$I_C = I_{C90}$, $V_{GE} = 15 \text{ V}$			2.7 V

Symbol	Test Conditions	Characteristic Values ($T_J = 25^\circ\text{C}$, unless otherwise specified)		
		min.	typ.	max.
g_{fs}	$I_C = I_{C90}$; $V_{CE} = 10\text{ V}$, Pulse test, $t \leq 300\ \mu\text{s}$, duty cycle $\leq 2\%$	25	35	S
Q_g	$I_C = I_{C90}$, $V_{GE} = 15\text{ V}$, $V_{CE} = 0.5 V_{CES}$		200	nC
Q_{ge}			50	nC
Q_{gc}			80	nC
$t_{d(on)}$	Inductive load, $T_J = 25^\circ\text{C}$		50	ns
t_{ri}	$I_C = I_{C90}$, $V_{GE} = 15\text{ V}$, $L = 100\ \mu\text{H}$, $V_{CE} = 0.8 V_{CES}$, $R_G = R_{off} = 2.7\ \Omega$		210	ns
$t_{d(off)}$			200	ns
t_{fi}	Remarks: Switching times may increase for $V_{CE}(\text{Clamp}) > 0.8 \cdot V_{CES}$, higher T_J or increased R_G		275	ns
E_{off}			4.8	mJ
$t_{d(on)}$	Inductive load, $T_J = 125^\circ\text{C}$		50	ns
t_{ri}	$I_C = I_{C90}$, $V_{GE} = 15\text{ V}$, $L = 100\ \mu\text{H}$, $V_{CE} = 0.8 V_{CES}$, $R_G = R_{off} = 2.7\ \Omega$		240	ns
E_{on}			3	mJ
$t_{d(off)}$	Remarks: Switching times may increase for $V_{CE}(\text{Clamp}) > 0.8 \cdot V_{CES}$, higher T_J or increased R_G		280	ns
t_{fi}			600	ns
E_{off}		9.6	mJ	
R_{thJC}				0.42 K/W
R_{thCK}		0.15		K/W

Reverse Diode (FRED)

Symbol	Test Conditions	Characteristic Values ($T_J = 25^\circ\text{C}$, unless otherwise specified)		
		min.	typ.	max.
V_F	$I_F = I_{C90}$, $V_{GE} = 0\text{ V}$, Pulse test, $t \leq 300\ \mu\text{s}$, duty cycle $d \leq 2\%$			1.7 V
I_{RM}	$I_F = I_{C90}$, $V_{GE} = 0\text{ V}$, $-di_F/dt = 480\text{ A}/\mu\text{s}$ $V_R = 360\text{ V}$ $T_J = 125^\circ\text{C}$ $I_F = 1\text{ A}$; $-di/dt = 200\text{ A}/\mu\text{s}$; $V_R = 30\text{ V}$ $T_J = 25^\circ\text{C}$		19	33 A
t_{rr}			175	ns
			35	50 ns
R_{thJC}				0.75 K/W

TO-247 HOLE-LESS

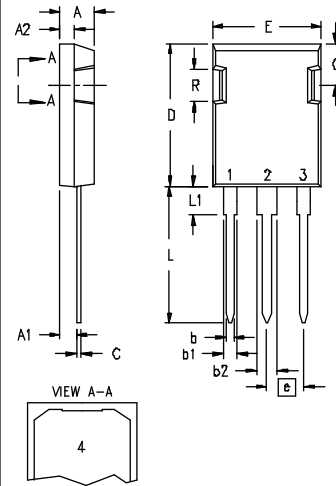

SYM	INCHES		MILLIMETERS	
	MIN	MAX	MIN	MAX
A	.190	.205	4.83	5.21
A1	.090	.100	2.29	2.54
A2	.075	.085	1.91	2.16
b	.045	.055	1.14	1.40
b1	.075	.084	1.91	2.13
b2	.115	.123	2.92	3.12
C	.024	.031	0.61	0.80
D	.819	.840	20.80	21.34
E	.620	.635	15.75	16.13
e	.215 BSC		5.45 BSC	
L	.780	.800	19.81	20.32
L1	.150	.170	3.81	4.32
Q	.220	.244	5.59	6.20
R	.170	.190	4.32	4.83

- 1 - GATE
- 2 - DRAIN (COLLECTOR)
- 3 - SOURCE (EMITTER)
- 4 - DRAIN (COLLECTOR)

TO-247 HOLE-LESS SMD

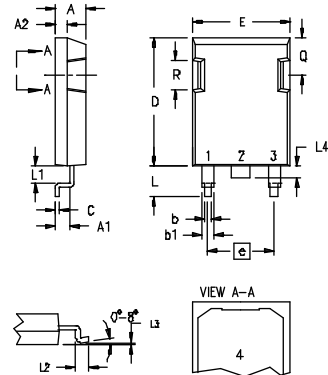

SYM	INCHES		MILLIMETERS	
	MIN	MAX	MIN	MAX
A	.190	.205	4.83	5.21
A1	.090	.100	2.29	2.54
A2	.075	.085	1.91	2.16
b	.045	.055	1.14	1.40
b1	.075	.084	1.91	2.13
C	.024	.031	0.61	0.80
D	.819	.840	20.80	21.34
E	.620	.635	15.75	16.13
e	.430 BSC		10.90 BSC	
L	.193	.201	4.90	5.10
L1	.106	.114	2.70	2.90
L2	.083	.091	2.10	2.30
L3	.00	.004	0.00	0.10
L4	.075	.083	1.90	2.10
Q	.220	.244	5.59	6.20
R	.170	.190	4.32	4.83

- 1 - GATE
- 2 - DRAIN (COLLECTOR)
- 3 - SOURCE (EMITTER)
- 4 - DRAIN (COLLECTOR)

NOTE: 1. This drawing meets all dimensions requirement of JEDEC outlines TO-247AD except L, L1, L2, L3, L4 and screw hole dia.
2. All metal surface are solder plated except trimmed area.

IXYS reserves the right to change limits, test conditions, and dimensions.

IXYS MOSFETS and IGBTs are covered by one or more of the following U.S. patents: 4,835,592 4,881,106 5,017,508 5,049,961 5,187,117 5,486,715
4,850,072 4,931,844 5,034,796 5,063,307 5,237,481 5,381,025

Fig. 1 Saturation Characteristics

Fig. 2 Output Characteristics

Fig. 3 Collector-Emitter Voltage vs. Gate-Emitter Voltage

Fig. 4 Temperature Dependence of Output Saturation Voltage

Fig. 5 Input Admittance

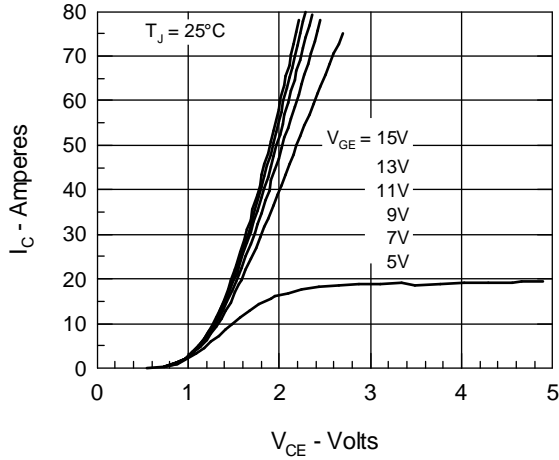
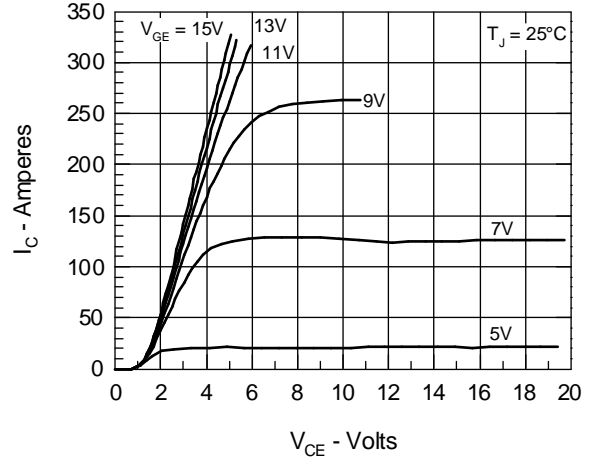
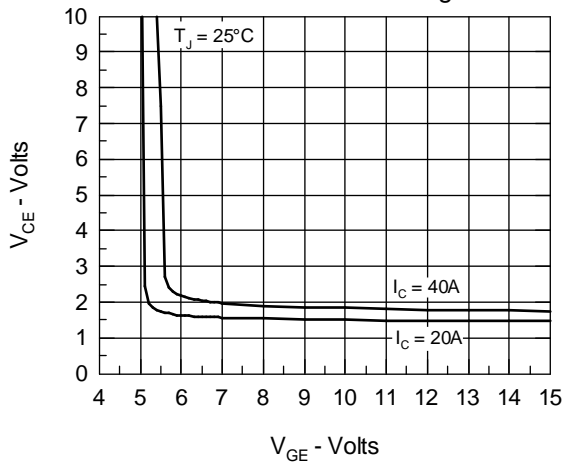
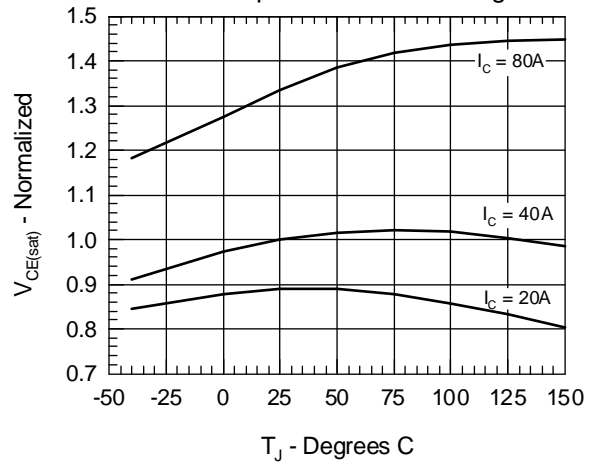
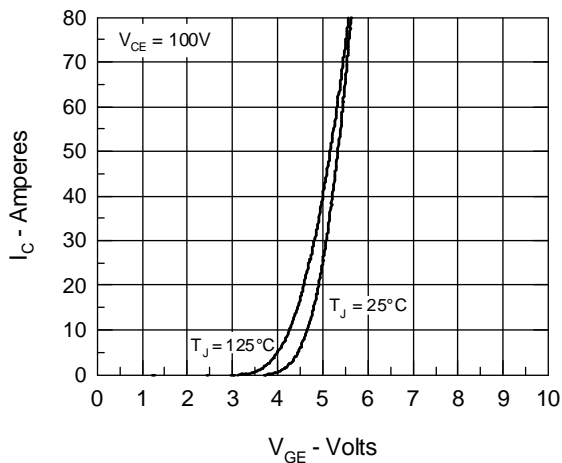
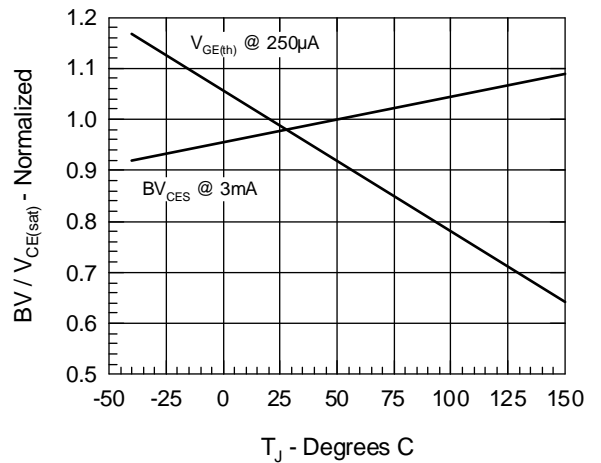
Fig. 6 Temperature Dependence of Breakdown and Threshold Voltage

Fig.7 Gate Charge

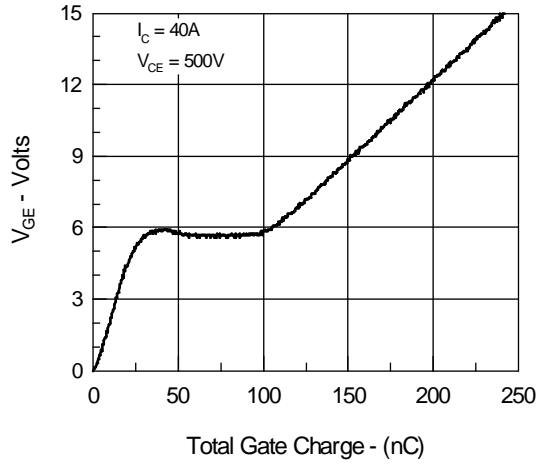

Fig.8 Turn-Off Safe Operating Area

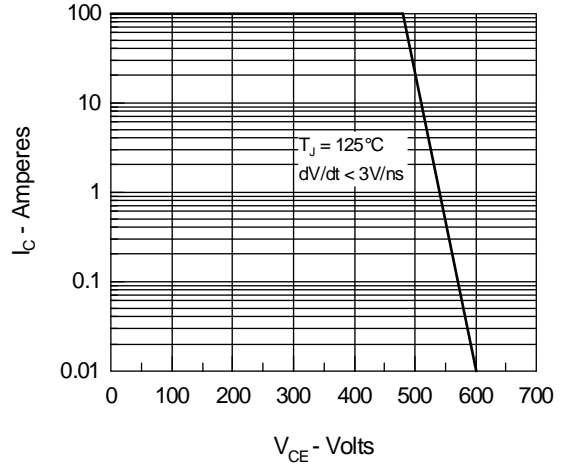

Fig.9 Capacitance Curves

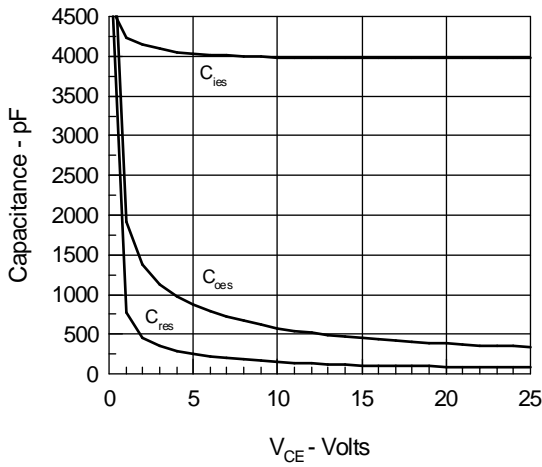
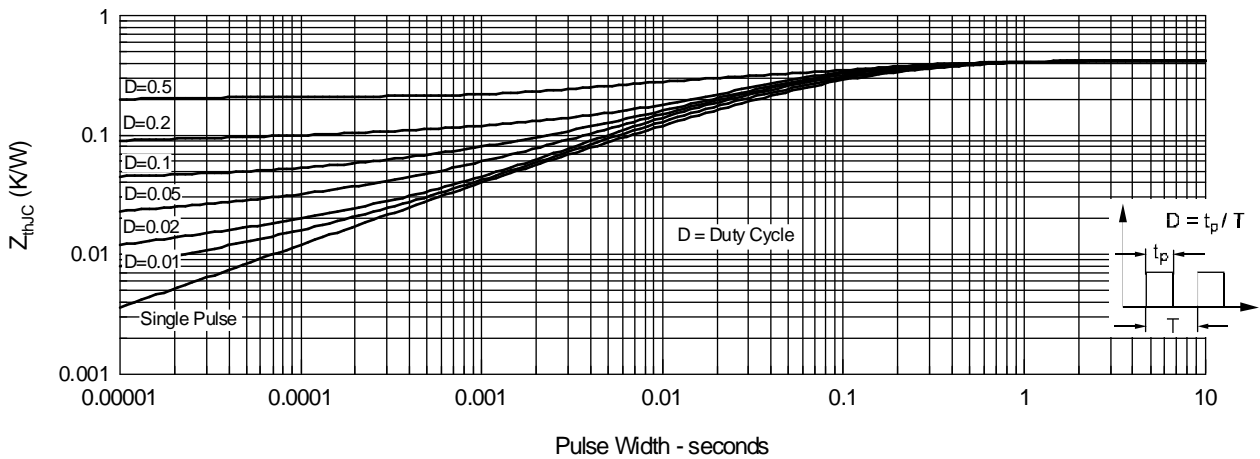

Fig.10 Transient Thermal Impedance



IXYS reserves the right to change limits, test conditions, and dimensions.

IXYS MOSFETS and IGBTs are covered by one or more of the following U.S. patents:

4,835,592	4,881,106	5,017,508	5,049,961	5,187,117	5,486,715
4,850,072	4,931,844	5,034,796	5,063,307	5,237,481	5,381,025

Fig. 12. Maximum Forward Voltage Drop

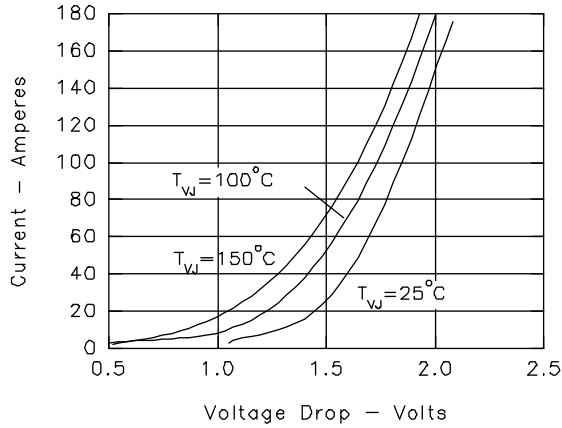

Fig. 13. Peak Forward Voltage V_{FR} and Forward Recovery Time t_{FR}

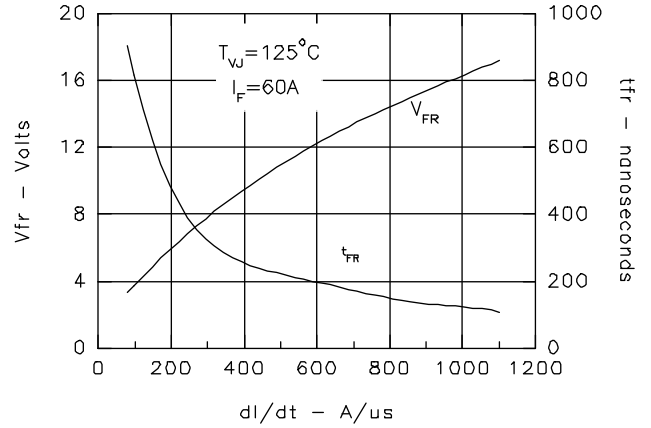

Fig. 14. Junction Temperature Dependence of I_{RM} and Q_R

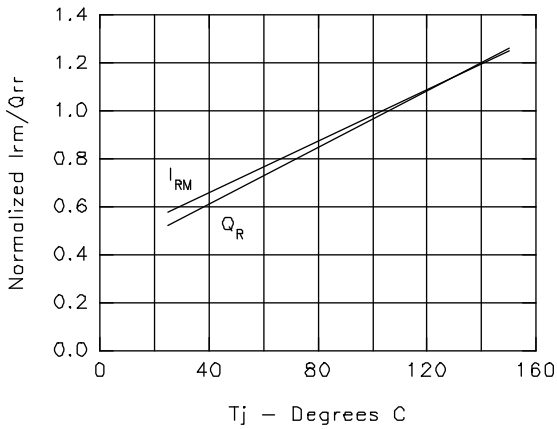

Fig. 15. Maximum Reverse Recovery Charge

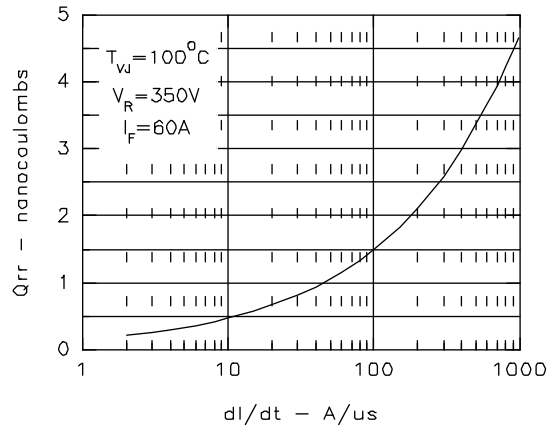

Figure 16. Peak Reverse Recovery Current.

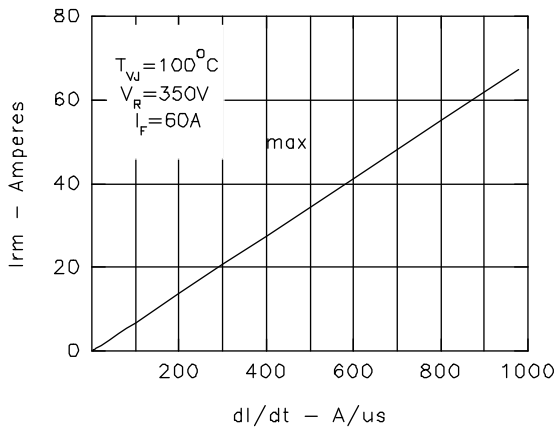
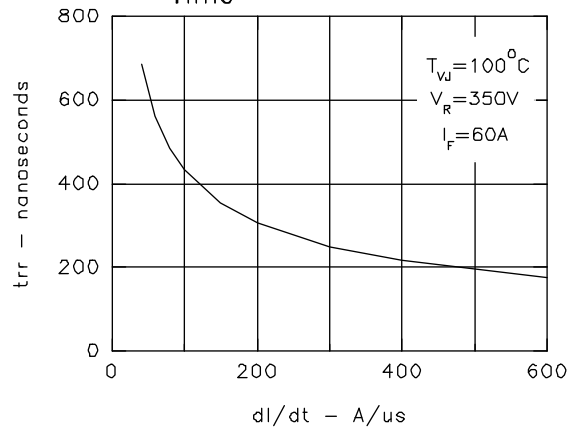

Fig. 17. Maximum Reverse Recovery Time



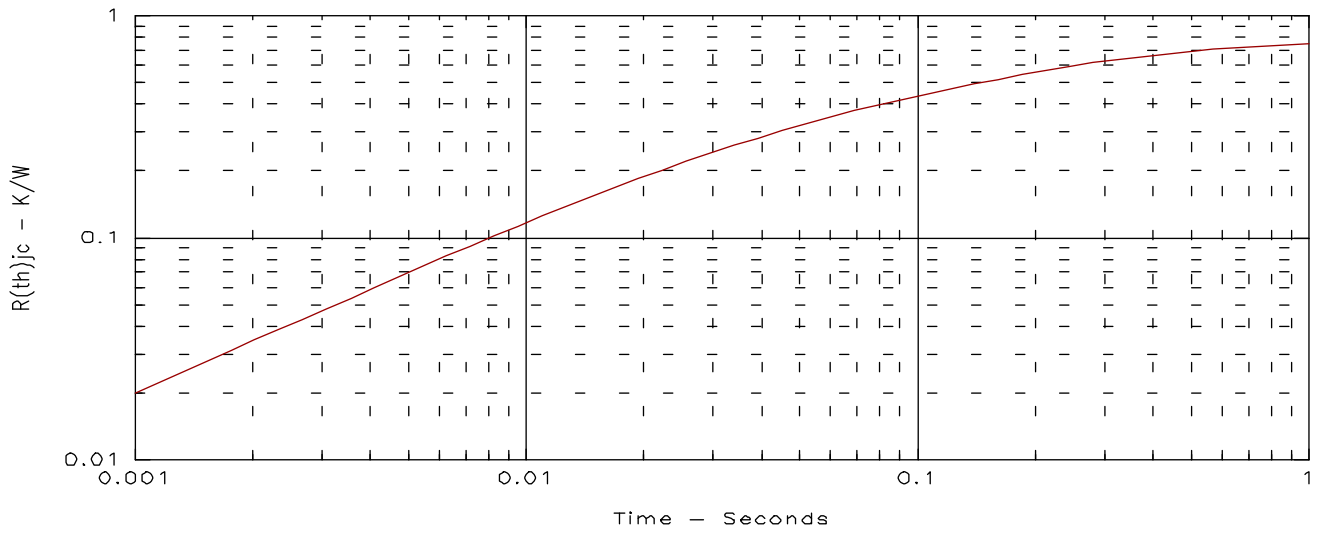

Fig. 18. Diode transient thermal resistance junction-to-case.