

HiPerFAST™ IGBT with Diode

IXGH 30N60BD1 IXGT 30N60BD1

$V_{CES} = 600 \text{ V}$
 $I_{C25} = 60 \text{ A}$
 $V_{CE(sat)} = 1.8 \text{ V}$
 $t_{fi(typ)} = 100 \text{ ns}$

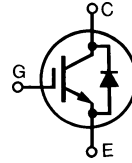

Symbol	Test Conditions	Maximum Ratings	
V_{CES}	$T_J = 25^\circ\text{C}$ to 150°C	600	V
V_{CGR}	$T_J = 25^\circ\text{C}$ to 150°C ; $R_{GE} = 1 \text{ M}\Omega$	600	V
V_{GES}	Continuous	± 20	V
V_{GEM}	Transient	± 30	V
I_{C25}	$T_C = 25^\circ\text{C}$	60	A
I_{C90}	$T_C = 90^\circ\text{C}$	30	A
I_{CM}	$T_C = 25^\circ\text{C}$, 1 ms	120	A
SSOA (RBSOA)	$V_{GE} = 15 \text{ V}$, $T_{VJ} = 125^\circ\text{C}$, $R_G = 10 \Omega$ Clamped inductive load, $L = 100 \mu\text{H}$	$I_{CM} = 60$ @ $0.8 V_{CES}$	A
P_C	$T_C = 25^\circ\text{C}$	200	W
T_J		-55 ... +150	$^\circ\text{C}$
T_{JM}		150	$^\circ\text{C}$
T_{stg}		-55 ... +150	$^\circ\text{C}$
Maximum Lead and Tab temperature for soldering 1.6 mm (0.062 in.) from case for 10 s		300	$^\circ\text{C}$
M_d	Mounting torque, TO-247 AD	1.13/10	Nm/lb.in.
Weight	TO-247 AD	6	g
	TO-268	4	g

**TO-268
(IXGT)**

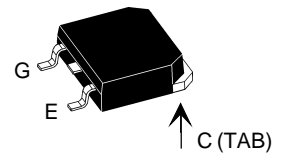

**TO-247 AD
(IXGH)**

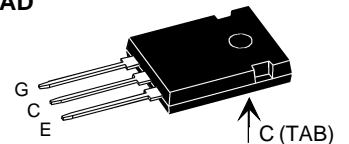

G = Gate, C = Collector,
E = Emitter, TAB = Collector

Features

- International standard package
- Moderate frequency IGBT and antiparallel FRED in one package
- High current handling capability
- Newest generation HDMOS™ process
- MOS Gate turn-on - drive simplicity

Applications

- AC motor speed control
- DC servo and robot drives
- DC choppers
- Uninterruptible power supplies (UPS)
- Switch-mode and resonant-mode power supplies

Advantages

- Space savings (two devices in one package)
- High power density
- Optimized $V_{CE(sat)}$ and switching speeds for medium frequency application

Symbol	Test Conditions	Characteristic Values ($T_J = 25^\circ\text{C}$, unless otherwise specified)		
		min.	typ.	max.
BV_{CES}	$I_C = 250 \mu\text{A}$, $V_{GE} = 0 \text{ V}$	600		V
$V_{GE(th)}$	$I_C = 250 \mu\text{A}$, $V_{CE} = V_{GE}$	2.5		5.0 V
I_{CES}	$V_{CE} = 0.8 \cdot V_{CES}$ $V_{GE} = 0 \text{ V}$	$T_J = 25^\circ\text{C}$		200 μA
		$T_J = 150^\circ\text{C}$		3 mA
I_{GES}	$V_{CE} = 0 \text{ V}$, $V_{GE} = \pm 20 \text{ V}$			$\pm 100 \text{ nA}$
$V_{CE(sat)}$	$I_C = I_{C90}$, $V_{GE} = 15 \text{ V}$			1.8 V

Symbol	Test Conditions	Characteristic Values ($T_J = 25^\circ\text{C}$, unless otherwise specified)			
		min.	typ.	max.	
g_{fs}	$I_C = I_{C90}$; $V_{CE} = 10\text{ V}$, Pulse test, $t \leq 300\ \mu\text{s}$, duty cycle $\leq 2\%$		25	S	
C_{ies}	$V_{CE} = 25\text{ V}$, $V_{GE} = 0\text{ V}$, $f = 1\text{ MHz}$		2700	pF	
C_{oes}			240	pF	
C_{res}			50	pF	
Q_g	$I_C = I_{C90}$; $V_{GE} = 15\text{ V}$, $V_{CE} = 0.5 V_{CES}$		110	nC	
Q_{ge}			22	nC	
Q_{gc}			40	nC	
$t_{d(on)}$	Inductive load, $T_J = 25^\circ\text{C}$ $I_C = I_{C90}$, $V_{GE} = 15\text{ V}$, $L = 100\ \mu\text{H}$, $V_{CE} = 0.8 V_{CES}$, $R_G = R_{off} = 4.7\ \Omega$ Remarks: Switching times may increase for V_{CE} (Clamp) $> 0.8 \cdot V_{CES}$, higher T_J or increased R_G		25	ns	
t_{ri}			30	ns	
$t_{d(off)}$			130	220	ns
t_{fi}			100	190	ns
E_{off}			1.0	2.0	mJ
$t_{d(on)}$	Inductive load, $T_J = 150^\circ\text{C}$ $I_C = I_{C90}$, $V_{GE} = 15\text{ V}$, $L = 100\ \mu\text{H}$, $V_{CE} = 0.8 V_{CES}$, $R_G = R_{off} = 4.7\ \Omega$ Remarks: Switching times may increase for V_{CE} (Clamp) $> 0.8 \cdot V_{CES}$, higher T_J or increased R_G		25	ns	
t_{ri}			35	ns	
E_{on}			1.0	mJ	
$t_{d(off)}$			200	ns	
t_{fi}			230	ns	
E_{off}		2.5	mJ		
R_{thJC}				0.62 K/W	
R_{thCK}	(TO-247 AD)		0.25	K/W	

TO-247 AD (IXGH) Outline

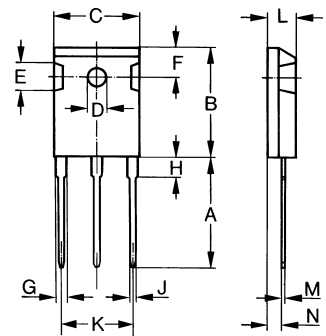

Dim.	Millimeter		Inches	
	Min.	Max.	Min.	Max.
A	19.81	20.32	0.780	0.800
B	20.80	21.46	0.819	0.845
C	15.75	16.26	0.610	0.640
D	3.55	3.65	0.140	0.144
E	4.32	5.49	0.170	0.216
F	5.4	6.2	0.212	0.244
G	1.65	2.13	0.065	0.084
H	-	4.5	-	0.177
J	1.0	1.4	0.040	0.055
K	10.8	11.0	0.426	0.433
L	4.7	5.3	0.185	0.209
M	0.4	0.8	0.016	0.031
N	1.5	2.49	0.087	0.102

Reverse Diode (FRED)

Symbol	Test Conditions	Characteristic Values ($T_J = 25^\circ\text{C}$, unless otherwise specified)		
		min.	typ.	max.
V_F	$I_F = I_{C90}$, $V_{GE} = 0\text{ V}$, Pulse test $t \leq 300\ \mu\text{s}$, duty cycle $d \leq 2\%$			1.6 V 2.5 V
I_{RM}	$I_F = I_{C90}$, $V_{GE} = 0\text{ V}$, $-di_F/dt = 100\text{ A}/\mu\text{s}$ $V_R = 100\text{ V}$ $I_F = 1\text{ A}$; $-di/dt = 100\text{ A}/\mu\text{s}$; $V_R = 30\text{ V}$		6	A
t_{rr}			100	ns
			25	ns
R_{thJC}				0.9 K/W

TO-268AA (D³ PAK)

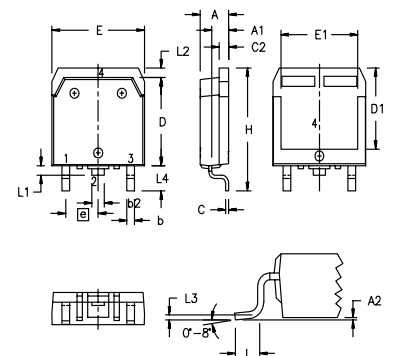

Dim.	Millimeter		Inches	
	Min.	Max.	Min.	Max.
A	4.9	5.1	.193	.201
A ₁	2.7	2.9	.106	.114
A ₂	.02	.25	.001	.010
b	1.15	1.45	.045	.057
b ₂	1.9	2.1	.75	.83
C	.4	.65	.016	.026
D	13.80	14.00	.543	.551
E	15.85	16.05	.624	.632
E ₁	13.3	13.6	.524	.535
e	5.45 BSC		.215 BSC	
H	18.70	19.10	.736	.752
L	2.40	2.70	.094	.106
L ₁	1.20	1.40	.047	.055
L ₂	1.00	1.15	.039	.045
L ₃	0.25 BSC		.010 BSC	
L ₄	3.80	4.10	.150	.161

Min. Recommended Footprint

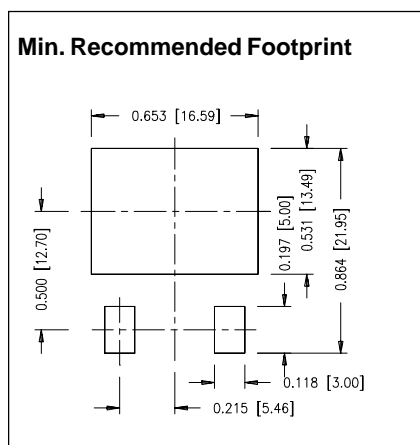

Fig. 1. Saturation Voltage Characteristics

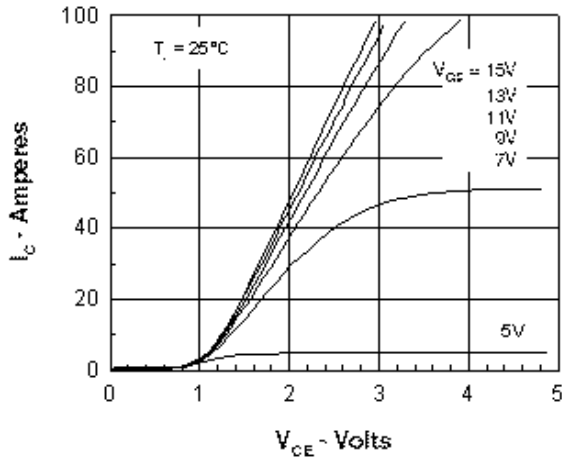

Fig. 3. Saturation Voltage Characteristics

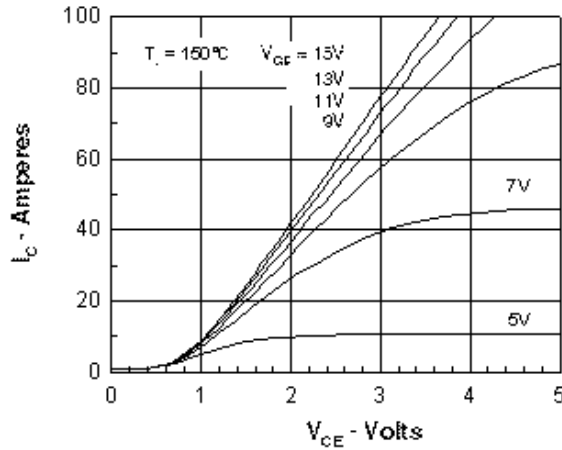

Fig. 5. Admittance Curves

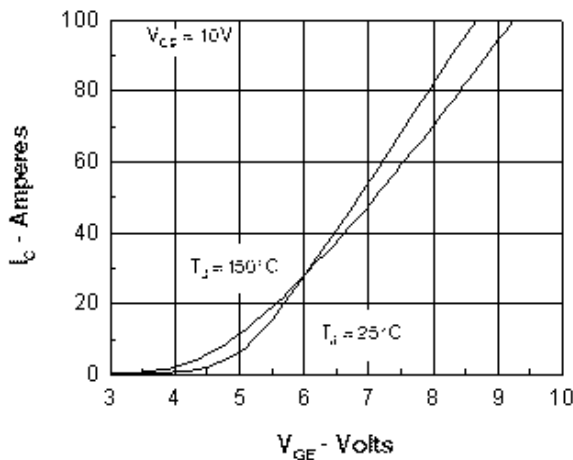

Fig. 2. Extended Output Characteristics

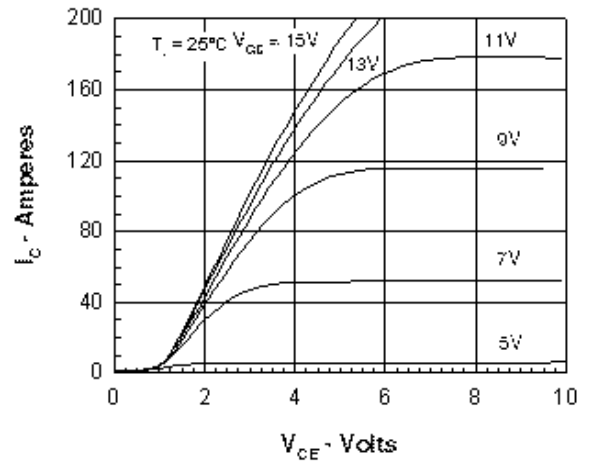
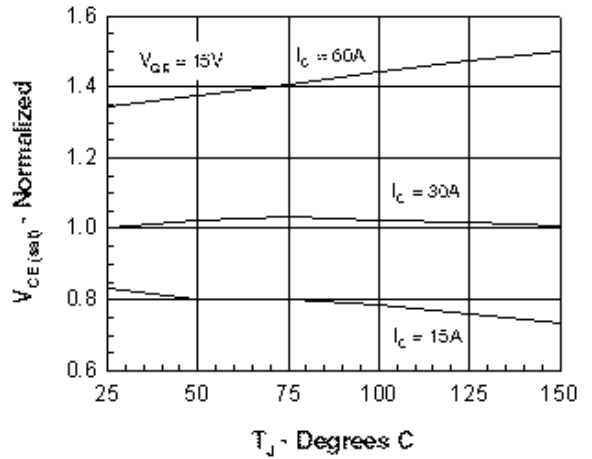
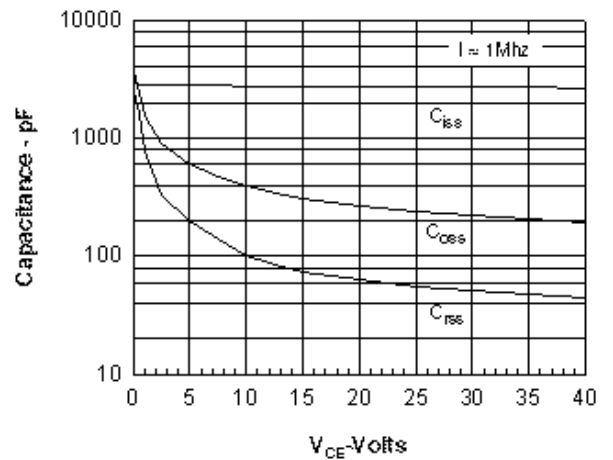

 Fig. 4. Temperature Dependence of $V_{CE(sat)}$

 Fig. 6. Temperature Dependence of BV_{DSS} & $V_{GE(th)}$

Fig. 7. Dependence of E_{OFF} and E_{ON} on I_C .

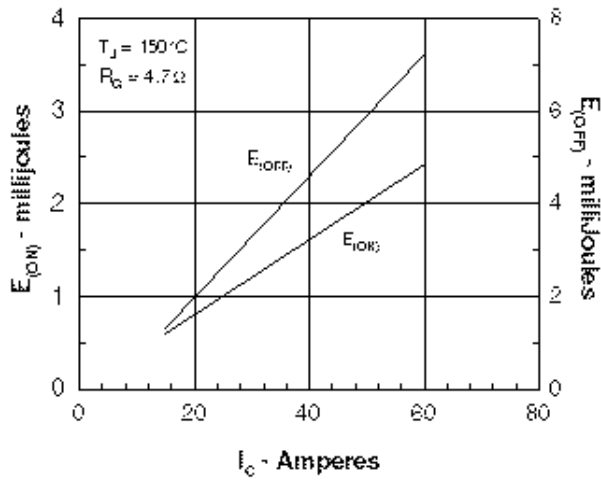

Fig. 8. Dependence of E_{OFF} on R_G .

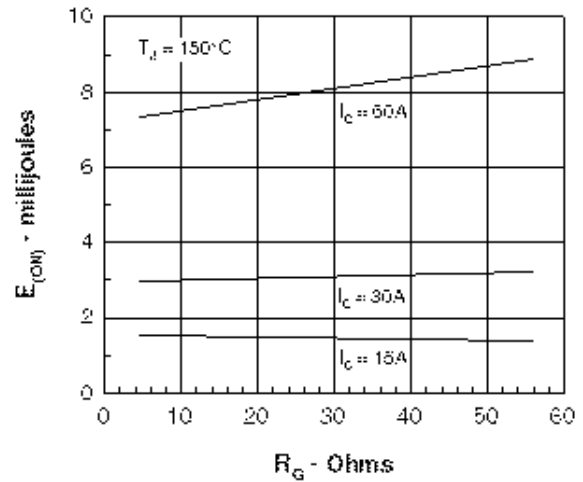

Fig. 9. Gate Charge

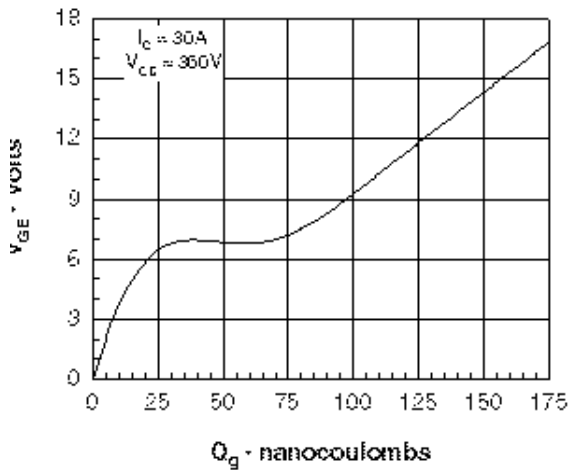

Fig. 10. Turn-off Safe Operating Area

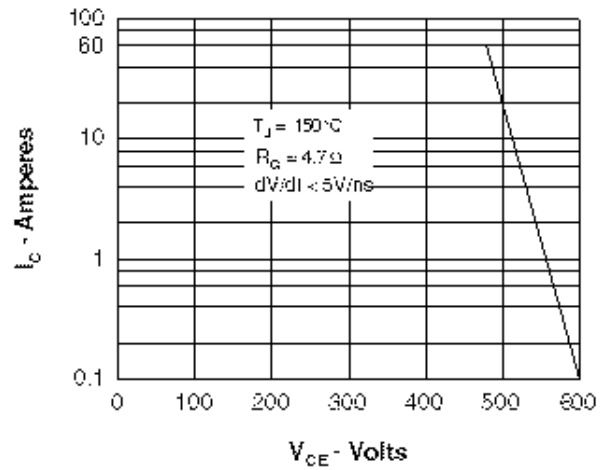
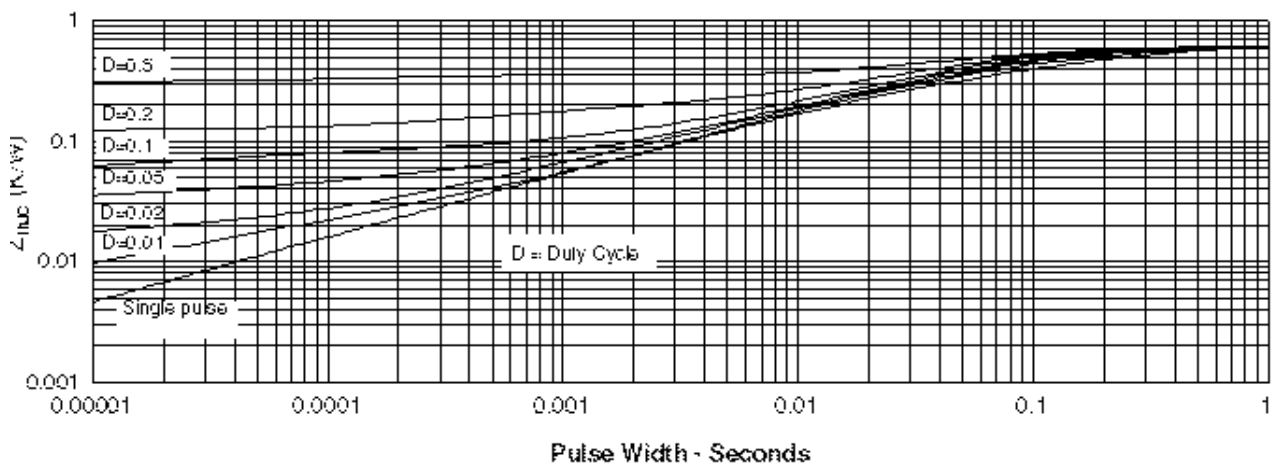

Fig. 11. IGBT Transient Thermal Resistance



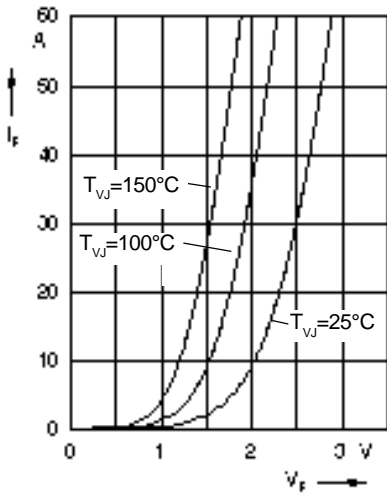

Fig. 12 Forward current I_F versus V_F

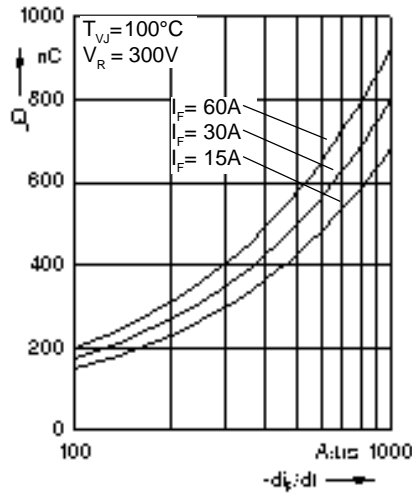

Fig. 13 Reverse recovery charge Q_r versus $-di_F/dt$

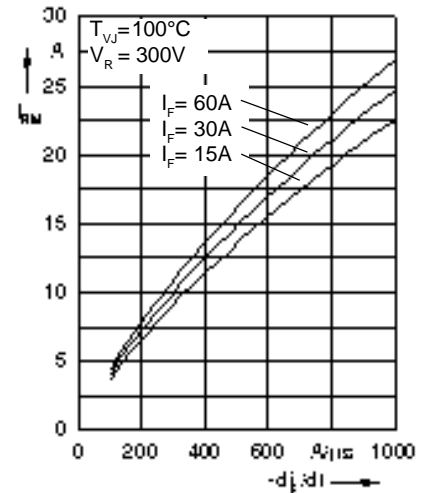

Fig. 14 Peak reverse current I_{RM} versus $-di_F/dt$

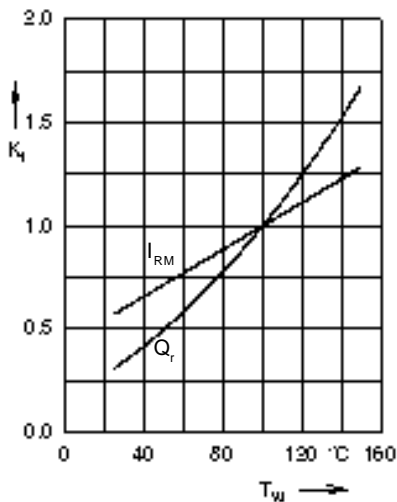

Fig. 15 Dynamic parameters Q_r , I_{RM} versus T_{VJ}

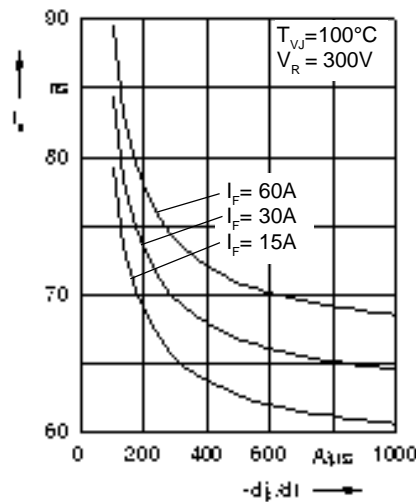

Fig. 16 Recovery time t_{tr} versus $-di_F/dt$

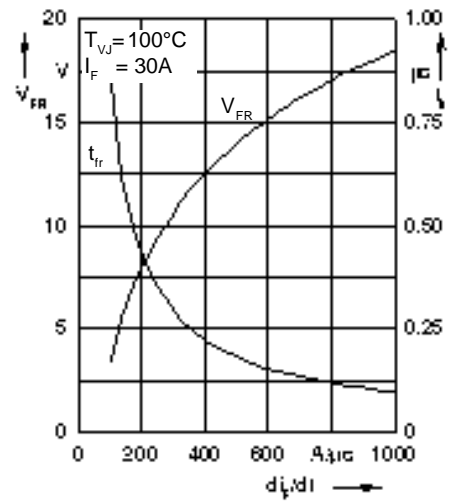

Fig. 17 Peak forward voltage V_{FR} and t_{tr} versus di_F/dt

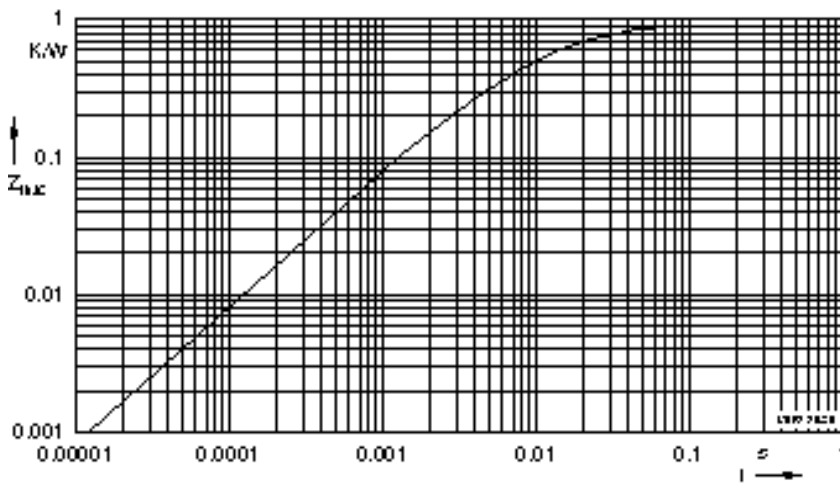

Fig. 18 Transient thermal resistance junction to case

Constants for Z_{thJC} calculation:

i	R_{thi} (K/W)	t_i (s)
1	0.502	0.0052
2	0.193	0.0003
3	0.205	0.0162