

# ISL9R18120G2 / ISL9R18120P2 / ISL9R18120S3S

## 18A, 1200V Stealth™ Diode

### General Description

The ISL9R18120G2, ISL9R18120P2 and ISL9R18120S3S are Stealth™ diodes optimized for low loss performance in high frequency hard switched applications. The Stealth™ family exhibits low reverse recovery current ( $I_{RM(REC)}$ ) and exceptionally soft recovery under typical operating conditions.

This device is intended for use as a free wheeling or boost diode in power supplies and other power switching applications. The low  $I_{RM(REC)}$  and short  $t_a$  phase reduce loss in switching transistors. The soft recovery minimizes ringing, expanding the range of conditions under which the diode may be operated without the use of additional snubber circuitry. Consider using the Stealth™ diode with a 1200V NPT IGBT to provide the most efficient and highest power density design at lower cost.

### Features

- Soft Recovery .....  $t_b / t_a > 5.0$
- Fast Recovery .....  $t_{rr} < 45\text{ns}$
- Operating Temperature .....  $150^\circ\text{C}$
- Reverse Voltage ..... 1200V
- Avalanche Energy Rated

### Applications

- Switch Mode Power Supplies
- Hard Switched PFC Boost Diode
- UPS Free Wheeling Diode
- Motor Drive FWD
- SMPS FWD
- Snubber Diode

### Package

### Symbol

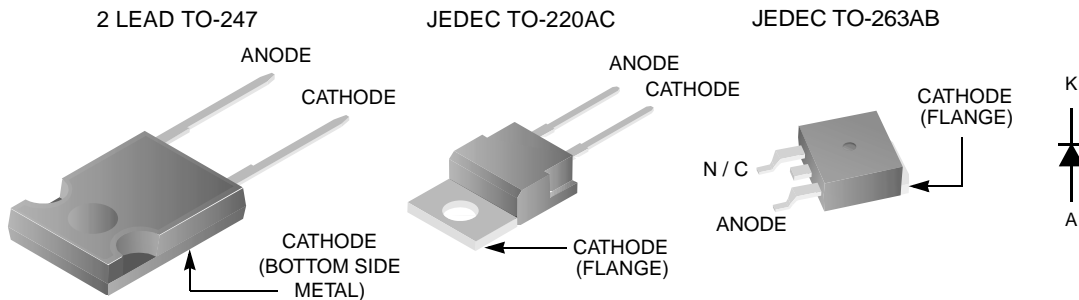

### Device Maximum Ratings $T_C = 25^\circ\text{C}$ unless otherwise noted

Symbol	Parameter	Ratings	Units
$V_{RRM}$	Repetitive Peak Reverse Voltage	1200	V
$V_{RWM}$	Working Peak Reverse Voltage	1200	V
$V_R$	DC Blocking Voltage	1200	V
$I_{F(AV)}$	Average Rectified Forward Current ( $T_C = 92^\circ\text{C}$ )	18	A
$I_{FRM}$	Repetitive Peak Surge Current (20kHz Square Wave)	36	A
$I_{FSM}$	Nonrepetitive Peak Surge Current (Halfwave 1 Phase 60Hz)	200	A
$P_D$	Power Dissipation	125	W
$E_{AVL}$	Avalanche Energy (1A, 40mH)	20	mJ
$T_J, T_{STG}$	Operating and Storage Temperature Range	-55 to 150	$^\circ\text{C}$
$T_L$	Maximum Temperature for Soldering		$^\circ\text{C}$
$T_{PKG}$	Leads at 0.063in (1.6mm) from Case for 10s Package Body for 10s, See Application Note AN-7528	300 260	$^\circ\text{C}$ $^\circ\text{C}$

CAUTION: Stresses above those listed in "Absolute Maximum Ratings" may cause permanent damage to the device. This is a stress only rating and operation of the device at these or any other conditions above those indicated in the operational sections of this specification is not implied.

ISL9R18120G2 / ISL9R18120P2 / ISL9R18120S3S

## Package Marking and Ordering Information

Device Marking	Device	Package	Tape Width	Quantity
R18120G2	ISL9R18120G2	TO-247	N/A	30
R18120P2	ISL9R18120P2	TO-220AC	N/A	50
R18120S3	ISL9R18120S3S	TO-263AB	24mm	800

## Electrical Characteristics $T_C = 25^\circ\text{C}$ unless otherwise noted

Symbol	Parameter	Test Conditions	Min	Typ	Max	Units
--------	-----------	-----------------	-----	-----	-----	-------

### Off State Characteristics

$I_R$	Instantaneous Reverse Current	$V_R = 1200\text{V}$	$T_C = 25^\circ\text{C}$	-	-	100	$\mu\text{A}$
			$T_C = 125^\circ\text{C}$	-	-	1.0	$\text{mA}$

### On State Characteristics

$V_F$	Instantaneous Forward Voltage	$I_F = 18\text{A}$	$T_C = 25^\circ\text{C}$	-	2.7	3.3	V
			$T_C = 125^\circ\text{C}$	-	2.5	3.1	V

### Dynamic Characteristics

$C_J$	Junction Capacitance	$V_R = 10\text{V}, I_F = 0\text{A}$	-	69	-	$\text{pF}$
-------	----------------------	-------------------------------------	---	----	---	-------------

### Switching Characteristics

$t_{rr}$	Reverse Recovery Time	$I_F = 1\text{A}, di_F/dt = 100\text{A}/\mu\text{s}, V_R = 30\text{V}$	-	38	45	ns
		$I_F = 18\text{A}, di_F/dt = 100\text{A}/\mu\text{s}, V_R = 30\text{V}$	-	60	70	ns
$t_{rr}$	Reverse Recovery Time	$I_F = 18\text{A},$	-	300	-	ns
$I_{RM(REC)}$	Maximum Reverse Recovery Current	$di_F/dt = 200\text{A}/\mu\text{s},$	-	6.5	-	A
$Q_{RR}$	Reverse Recovered Charge	$V_R = 780\text{V}, T_C = 25^\circ\text{C}$	-	950	-	nC
$t_{rr}$	Reverse Recovery Time	$I_F = 18\text{A},$	-	400	-	ns
S	Softness Factor ( $t_b/t_a$ )	$di_F/dt = 200\text{A}/\mu\text{s},$	-	7.0	-	-
$I_{RM(REC)}$	Maximum Reverse Recovery Current	$V_R = 780\text{V},$	-	8.0	-	A
$Q_{RR}$	Reverse Recovered Charge	$T_C = 125^\circ\text{C}$	-	2.0	-	$\mu\text{C}$
$t_{rr}$	Reverse Recovery Time	$I_F = 18\text{A},$	-	235	-	ns
S	Softness Factor ( $t_b/t_a$ )	$di_F/dt = 1000\text{A}/\mu\text{s},$	-	5.2	-	-
$I_{RM(REC)}$	Maximum Reverse Recovery Current	$V_R = 780\text{V},$	-	22	-	A
$Q_{RR}$	Reverse Recovered Charge	$T_C = 125^\circ\text{C}$	-	2.1	-	$\mu\text{C}$
$di_M/dt$	Maximum $di/dt$ during $t_b$		-	370	-	$\text{A}/\mu\text{s}$

### Thermal Characteristics

$R_{\theta JC}$	Thermal Resistance Junction to Case	TO-247, TO-220, TO-263	-	-	1.0	$^\circ\text{C}/\text{W}$
$R_{\theta JA}$	Thermal Resistance Junction to Ambient	TO-247	-	-	30	$^\circ\text{C}/\text{W}$
$R_{\theta JA}$	Thermal Resistance Junction to Ambient	TO-220, TO-263	-	-	62	$^\circ\text{C}/\text{W}$

### Typical Performance Curves

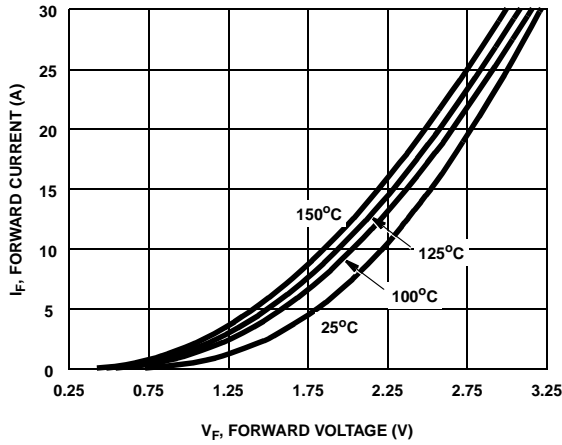

Figure 1. Forward Current vs Forward Voltage

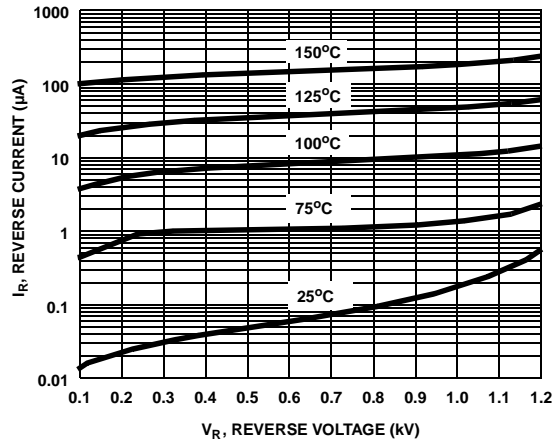

Figure 2. Reverse Current vs Reverse Voltage

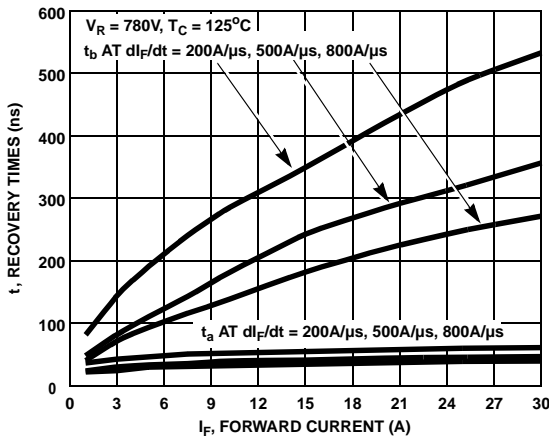

Figure 3.  $t_a$  and  $t_b$  Curves vs Forward Current

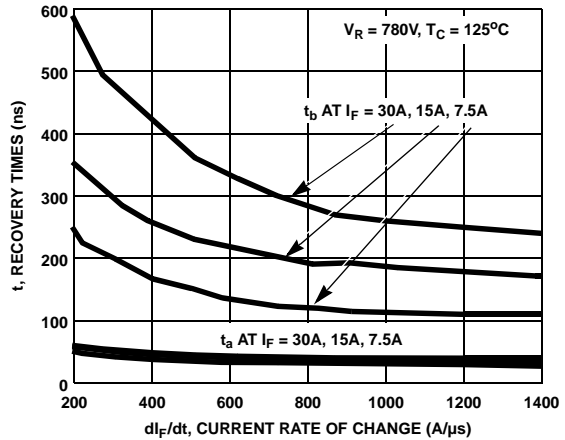

Figure 4.  $t_a$  and  $t_b$  Curves vs  $di_F/dt$

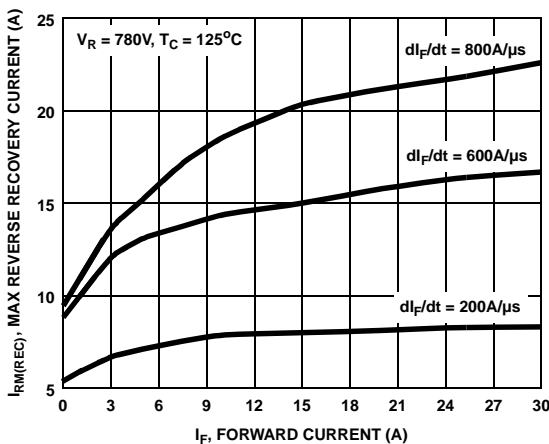

Figure 5. Maximum Reverse Recovery Current vs Forward Current

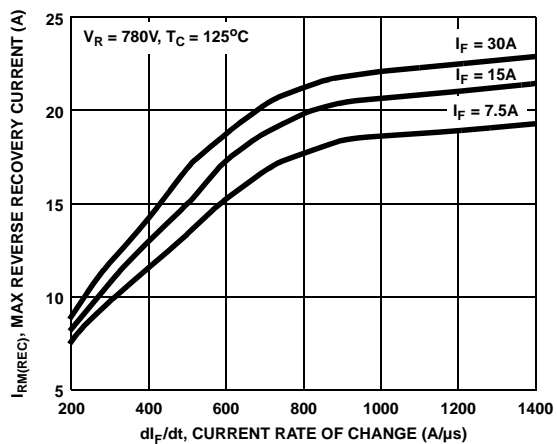

Figure 6. Maximum Reverse Recovery Current vs  $di_F/dt$

Typical Performance Curves (Continued)

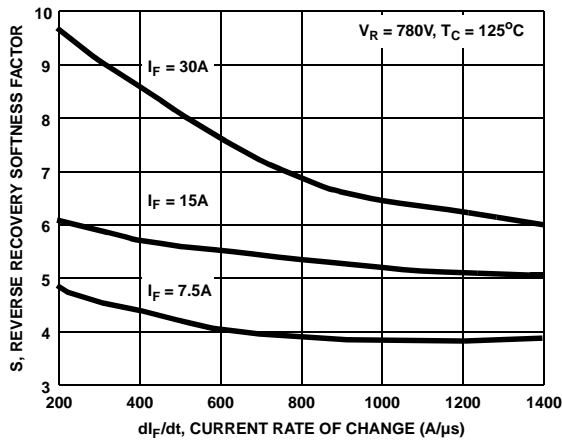

Figure 7. Reverse Recovery Softness Factor vs  $dI_F/dt$

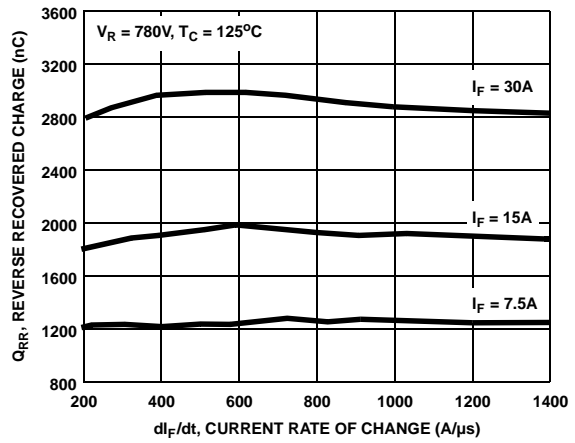

Figure 8. Reverse Recovered Charge vs  $dI_F/dt$

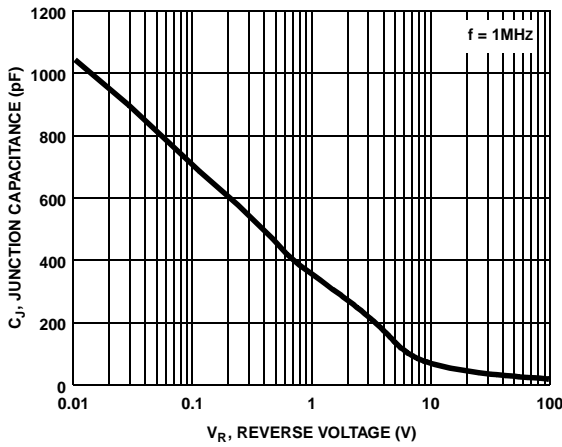

Figure 9. Junction Capacitance vs Reverse Voltage

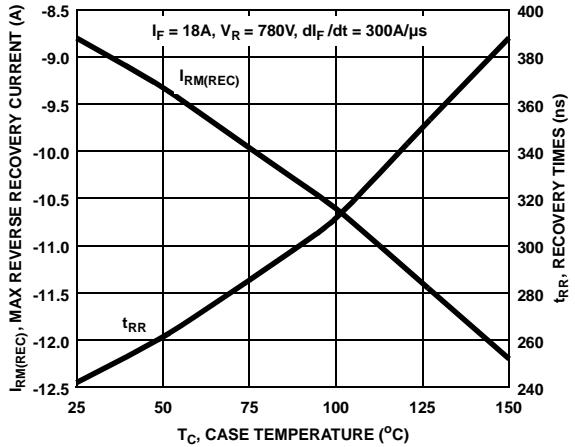

Figure 10. Reverse Recovery Current and Times vs Case Temperature

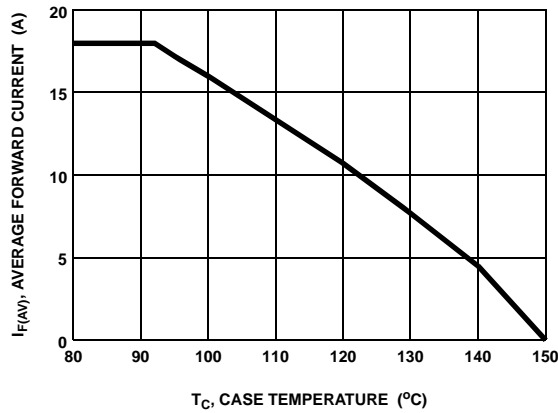

Figure 11. DC Current Derating Curve

Typical Performance Curves (Continued)

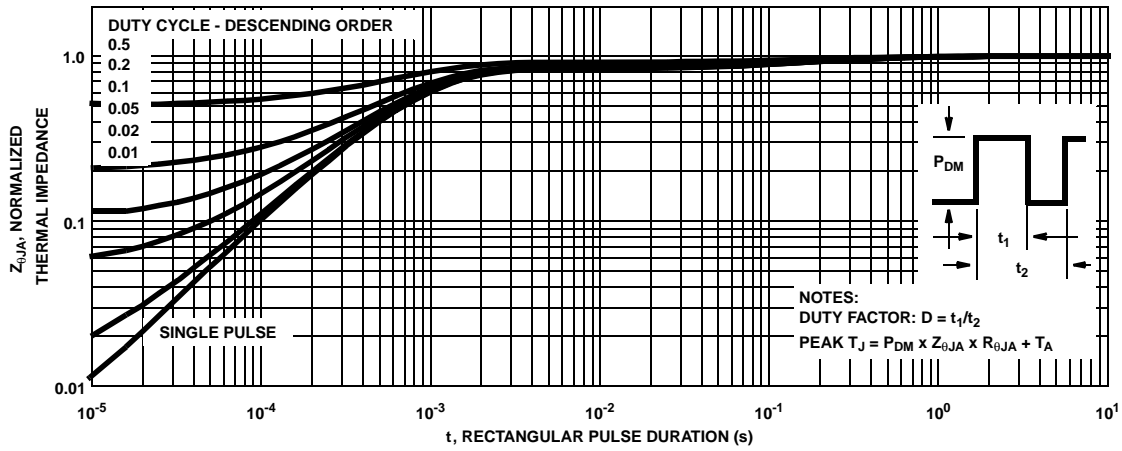

Figure 12. Normalized Maximum Transient Thermal Impedance

Test Circuit and Waveforms

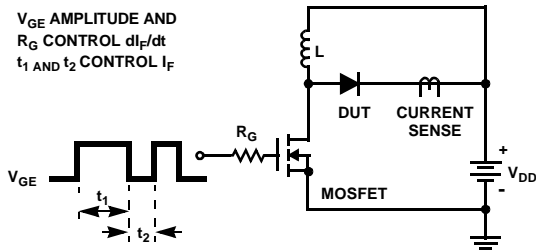

Figure 13.  $t_{rr}$  Test Circuit

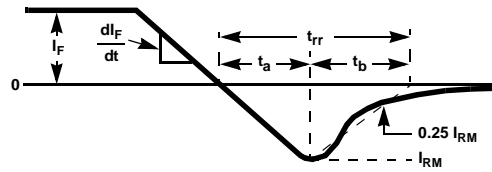
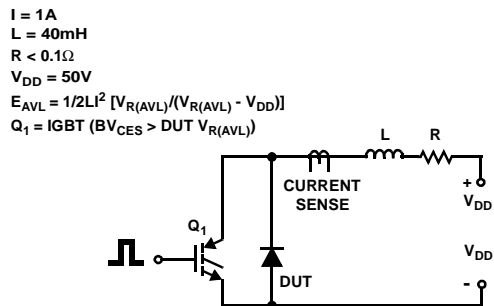

Figure 14.  $t_{rr}$  Waveforms and Definitions



$I = 1A$   
 $L = 40mH$   
 $R < 0.1\Omega$   
 $V_{DD} = 50V$   
 $E_{AVL} = 1/2LI^2 [V_{R(AVL)}/(V_{R(AVL)} - V_{DD})]$   
 $Q_1 = IGBT (BV_{CES} > DUT V_{R(AVL)})$

Figure 15. Avalanche Energy Test Circuit

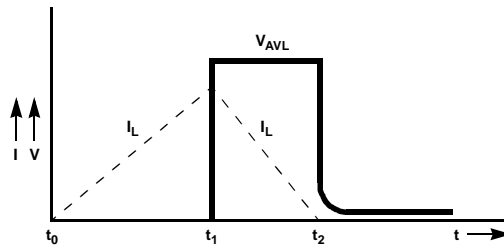

Figure 16. Avalanche Current and Voltage Waveforms

## TRADEMARKS

The following are registered and unregistered trademarks Fairchild Semiconductor owns or is authorized to use and is not intended to be an exhaustive list of all such trademarks.

ACEx™	FACT Quiet Series™	ISOPLANAR™	POP™	Stealth™
ActiveArray™	FAST®	LittleFET™	Power247™	SuperFET™
Bottomless™	FASTr™	MICROCOUPLER™	PowerSaver™	SuperSOT™-3
CoolFET™	FPST™	MicroFET™	PowerTrench®	SuperSOT™-6
CROSSVOLT™	FRFET™	MicroPak™	QFET®	SuperSOT™-8
DOMET™	GlobalOptoisolator™	MICROWIRE™	QS™	SyncFET™
EcoSPARK™	GTO™	MSX™	QT Optoelectronics™	TinyLogic®
E <sup>2</sup> CMOS™	HiSeC™	MSXPro™	Quiet Series™	TINYOPTO™
EnSigna™	µC™	OCX™	RapidConfigure™	TruTranslation™
FACT™	ImpliedDisconnect™	OCXPro™	RapidConnect™	UHC™
Across the board. Around the world.™	OPTOLOGIC®	SILENT SWITCHER®	SMART START™	UltraFET®
The Power Franchise®	OPTOPLANAR™	SPM™		VCX™
Programmable Active Droop™	PACMAN™			

## DISCLAIMER

FAIRCHILD SEMICONDUCTOR RESERVES THE RIGHT TO MAKE CHANGES WITHOUT FURTHER NOTICE TO ANY PRODUCTS HEREIN TO IMPROVE RELIABILITY, FUNCTION OR DESIGN. FAIRCHILD DOES NOT ASSUME ANY LIABILITY ARISING OUT OF THE APPLICATION OR USE OF ANY PRODUCT OR CIRCUIT DESCRIBED HEREIN; NEITHER DOES IT CONVEY ANY LICENSE UNDER ITS PATENT RIGHTS, NOR THE RIGHTS OF OTHERS.

## LIFE SUPPORT POLICY

FAIRCHILD'S PRODUCTS ARE NOT AUTHORIZED FOR USE AS CRITICAL COMPONENTS IN LIFE SUPPORT DEVICES OR SYSTEMS WITHOUT THE EXPRESS WRITTEN APPROVAL OF FAIRCHILD SEMICONDUCTOR CORPORATION. As used herein:

1. Life support devices or systems are devices or systems which, (a) are intended for surgical implant into the body, or (b) support or sustain life, or (c) whose failure to perform when properly used in accordance with instructions for use provided in the labeling, can be reasonably expected to result in significant injury to the user.
2. A critical component is any component of a life support device or system whose failure to perform can be reasonably expected to cause the failure of the life support device or system, or to affect its safety or effectiveness.

## PRODUCT STATUS DEFINITIONS

### Definition of Terms

Datasheet Identification	Product Status	Definition
Advance Information	Formative or In Design	This datasheet contains the design specifications for product development. Specifications may change in any manner without notice.
Preliminary	First Production	This datasheet contains preliminary data, and supplementary data will be published at a later date. Fairchild Semiconductor reserves the right to make changes at any time without notice in order to improve design.
No Identification Needed	Full Production	This datasheet contains final specifications. Fairchild Semiconductor reserves the right to make changes at any time without notice in order to improve design.
Obsolete	Not In Production	This datasheet contains specifications on a product that has been discontinued by Fairchild semiconductor. The datasheet is printed for reference information only.