

**RADIATION HARDENED  
 POWER MOSFET  
 THRU-HOLE (Low-Ohmic TO-254AA)**

**IRHMS67164  
 150V, N-CHANNEL  
 **R6 TECHNOLOGY****

**Product Summary**

Part Number	Radiation Level	R <sub>DS(on)</sub>	I <sub>D</sub>
IRHMS67164	100K Rads (Si)	0.019Ω	45A*
IRHMS63164	300K Rads (Si)	0.019Ω	45A*



International Rectifier's R6™ technology provides superior power MOSFETs for space applications. These devices have improved immunity to Single Event Effect (SEE) and have been characterized for useful performance with Linear Energy Transfer (LET) up to 90MeV/(mg/cm<sup>2</sup>).

Their combination of very low R<sub>DS(on)</sub> and faster switching times reduces power loss and increases power density in today's high speed switching applications such as DC-DC converters and motor controllers. These devices retain all of the well established advantages of MOSFETs such as voltage control, ease of paralleling and temperature stability of electrical parameters.

**Features:**

- Low R<sub>DS(on)</sub>
- Fast Switching
- Single Event Effect (SEE) Hardened
- Low Total Gate Charge
- Simple Drive Requirements
- Ease of Paralleling
- Hermetically Sealed
- Ceramic Eyelets
- Electrically Isolated
- Light Weight

**Absolute Maximum Ratings**

**Pre-Irradiation**

	Parameter		Units
I <sub>D</sub> @ V <sub>GS</sub> = 12V, T <sub>C</sub> = 25°C	Continuous Drain Current	45*	A
I <sub>D</sub> @ V <sub>GS</sub> = 12V, T <sub>C</sub> = 100°C	Continuous Drain Current	44	
I <sub>DM</sub>	Pulsed Drain Current ①	180	
P <sub>D</sub> @ T <sub>C</sub> = 25°C	Max. Power Dissipation	208	W
	Linear Derating Factor	1.67	W/°C
V <sub>GS</sub>	Gate-to-Source Voltage	±20	V
EAS	Single Pulse Avalanche Energy ②	353	mJ
I <sub>AR</sub>	Avalanche Current ①	45	A
EAR	Repetitive Avalanche Energy ①	20.8	mJ
dv/dt	Peak Diode Recovery dv/dt ③	8.2	V/ns
T <sub>J</sub>	Operating Junction	-55 to 150	°C
T <sub>STG</sub>	Storage Temperature Range		
	Lead Temperature	300 (0.063 in. /1.6 mm from case for 10s)	
	Weight	9.3 (Typical)	

\* Current is limited by package  
 For footnotes refer to the last page

**Electrical Characteristics @ T<sub>j</sub> = 25°C (Unless Otherwise Specified)**

	Parameter	Min	Typ	Max	Units	Test Conditions
B <sub>V</sub> DSS	Drain-to-Source Breakdown Voltage	150	—	—	V	V <sub>GS</sub> = 0V, I <sub>D</sub> = 1.0mA
ΔB <sub>V</sub> DSS/ΔT <sub>J</sub>	Temperature Coefficient of Breakdown Voltage	—	0.18	—	V/°C	Reference to 25°C, I <sub>D</sub> = 1.0mA
R <sub>DS(on)</sub>	Static Drain-to-Source On-State Resistance	—	—	0.019	Ω	V <sub>GS</sub> = 12V, I <sub>D</sub> = 44A ④
V <sub>GS(th)</sub>	Gate Threshold Voltage	2.0	—	4.0	V	V <sub>DS</sub> = V <sub>GS</sub> , I <sub>D</sub> = 1.0mA
g <sub>fs</sub>	Forward Transconductance	49	—	—	S (S)	V <sub>DS</sub> = 15V, I <sub>DS</sub> = 44A ④
I <sub>DSS</sub>	Zero Gate Voltage Drain Current	—	—	10	μA	V <sub>DS</sub> = 120V, V <sub>GS</sub> = 0V
		—	—	25		V <sub>DS</sub> = 120V, V <sub>GS</sub> = 0V, T <sub>J</sub> = 125°C
I <sub>GSS</sub>	Gate-to-Source Leakage Forward	—	—	100	nA	V <sub>GS</sub> = 20V
I <sub>GSS</sub>	Gate-to-Source Leakage Reverse	—	—	-100		V <sub>GS</sub> = -20V
Q <sub>g</sub>	Total Gate Charge	—	—	230	nC	V <sub>GS</sub> = 12V, I <sub>D</sub> = 45A
Q <sub>gs</sub>	Gate-to-Source Charge	—	—	55		V <sub>DS</sub> = 75V
Q <sub>gd</sub>	Gate-to-Drain ('Miller') Charge	—	—	90		
t <sub>d(on)</sub>	Turn-On Delay Time	—	—	35	ns	V <sub>DD</sub> = 75V, I <sub>D</sub> = 45A
t <sub>r</sub>	Rise Time	—	—	120		V <sub>GS</sub> = 12V, R <sub>G</sub> = 2.35Ω
t <sub>d(off)</sub>	Turn-Off Delay Time	—	—	85		
t <sub>f</sub>	Fall Time	—	—	25		
L <sub>S</sub> + L <sub>D</sub>	Total Inductance	—	6.8	—	nH	Measured from Drain lead (6mm /0.25in. from package) to Source lead (6mm /0.25in. from package) with Source wires internally bonded from Source Pin to Drain Pad
C <sub>iss</sub>	Input Capacitance	—	7380	—	pF	V <sub>GS</sub> = 0V, V <sub>DS</sub> = 25V
C <sub>oss</sub>	Output Capacitance	—	1140	—		f = 1.0MHz
C <sub>rss</sub>	Reverse Transfer Capacitance	—	28	—		
R <sub>g</sub>	Internal Gate Resistance	—	0.52	—		Ω

**Source-Drain Diode Ratings and Characteristics**

	Parameter	Min	Typ	Max	Units	Test Conditions
I <sub>S</sub>	Continuous Source Current (Body Diode)	—	—	45*	A	
I <sub>SM</sub>	Pulse Source Current (Body Diode) ①	—	—	180		
V <sub>SD</sub>	Diode Forward Voltage	—	—	1.2	V	T <sub>j</sub> = 25°C, I <sub>S</sub> = 45A, V <sub>GS</sub> = 0V ④
t <sub>rr</sub>	Reverse Recovery Time	—	—	370	ns	T <sub>j</sub> = 25°C, I <sub>F</sub> = 45A, di/dt ≤ 100A/μs
Q <sub>RR</sub>	Reverse Recovery Charge	—	—	3.8	μC	V <sub>DD</sub> ≤ 50V ④
t <sub>on</sub>	Forward Turn-On Time	Intrinsic turn-on time is negligible. Turn-on speed is substantially controlled by L <sub>S</sub> + L <sub>D</sub> .				

\* Current is limited by package

**Thermal Resistance**

	Parameter	Min	Typ	Max	Units	Test Conditions
R <sub>thJC</sub>	Junction-to-Case	—	—	0.60	°C/W	
R <sub>thCS</sub>	Case-to-Sink	—	0.21	—		
R <sub>thJA</sub>	Junction-to-Ambient	—	—	48		Typical socket mount

Note: Corresponding Spice and Saber models are available on International Rectifier Web site.

For footnotes refer to the last page

## Radiation Characteristics

IRHMS67164

International Rectifier Radiation Hardened MOSFETs are tested to verify their radiation hardness capability. The hardness assurance program at International Rectifier is comprised of two radiation environments. Every manufacturing lot is tested for total ionizing dose (per notes 5 and 6) using the TO-3 package. Both pre- and post-irradiation performance are tested and specified using the same drive circuitry and test conditions in order to provide a direct comparison.

**Table 1. Electrical Characteristics @ Tj = 25°C, Post Total Dose Irradiation ⑤⑥**

	Parameter	Up to 300K Rads (Si)		Units	Test Conditions ③
		Min	Max		
BV <sub>DSS</sub>	Drain-to-Source Breakdown Voltage	150	—	V	V <sub>GS</sub> = 0V, I <sub>D</sub> = 1.0mA
V <sub>GS(th)</sub>	Gate Threshold Voltage	2.0	4.0		V <sub>GS</sub> = V <sub>DS</sub> , I <sub>D</sub> = 1.0mA
I <sub>GSS</sub>	Gate-to-Source Leakage Forward	—	100	nA	V <sub>GS</sub> = 20V
I <sub>GSS</sub>	Gate-to-Source Leakage Reverse	—	-100		V <sub>GS</sub> = -20V
I <sub>DSS</sub>	Zero Gate Voltage Drain Current	—	10	μA	V <sub>DS</sub> = 120V, V <sub>GS</sub> = 0V
R <sub>DS(on)</sub>	Static Drain-to-Source ④				
	On-State Resistance (TO-3)	—	0.019	Ω	V <sub>GS</sub> = 12V, I <sub>D</sub> = 44A
R <sub>DS(on)</sub>	Static Drain-to-Source On-State ④ Resistance (Low Ohmic TO-254AA)	—	0.019	Ω	V <sub>GS</sub> = 12V, I <sub>D</sub> = 44A
V <sub>SD</sub>	Diode Forward Voltage ③	—	1.2	V	V <sub>GS</sub> = 0V, I <sub>D</sub> = 45A

Part numbers IRHMS67164 and IRHMS63164

International Rectifier radiation hardened MOSFETs have been characterized in heavy ion environment for Single Event Effects (SEE). Single Event Effects characterization is illustrated in Fig. a and Tables.

### Tables for Single Event Effect Safe Operating Area

Ion Kr LET = 39 MeV/(mg/cm <sup>2</sup> ) Energy = 312 MeV Range = 39 μm	
VGS Bias (Volts)	VDS Bias (Volts)
0	150
-5	150
-10	150
-15	150
-20	150

Ion Xe LET = 59 MeV/(mg/cm <sup>2</sup> ) Energy = 825 MeV Range = 66 μm	
VGS Bias (Volts)	VDS Bias (Volts)
0	150
-5	150
-9	150
-10	140
-11	50
-15	40

Ion Au LET = 90 MeV/(mg/cm <sup>2</sup> ) Energy = 1480 MeV Range = 80 μm	
VGS Bias (Volts)	VDS Bias (Volts)
0	50
-5	50
-10	30

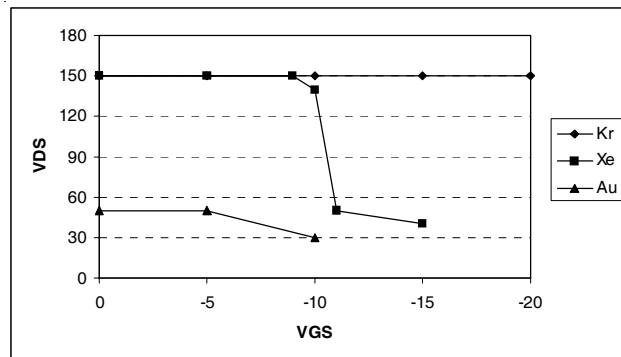

**Fig a. Single Event Effect, Safe Operating Area**

For footnotes refer to the last page

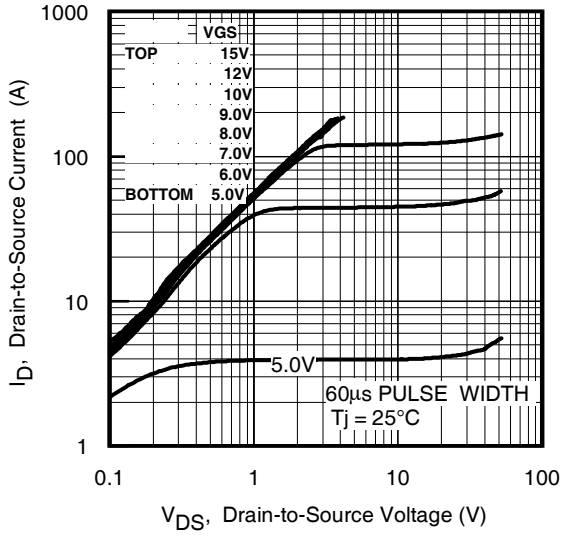

Fig 1. Typical Output Characteristics

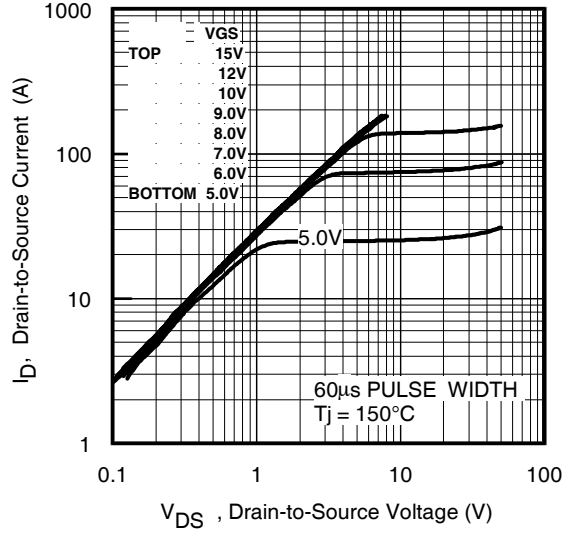

Fig 2. Typical Output Characteristics

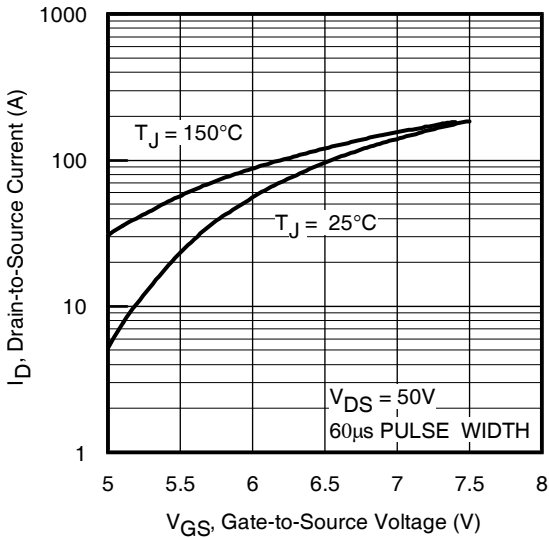

Fig 3. Typical Transfer Characteristics

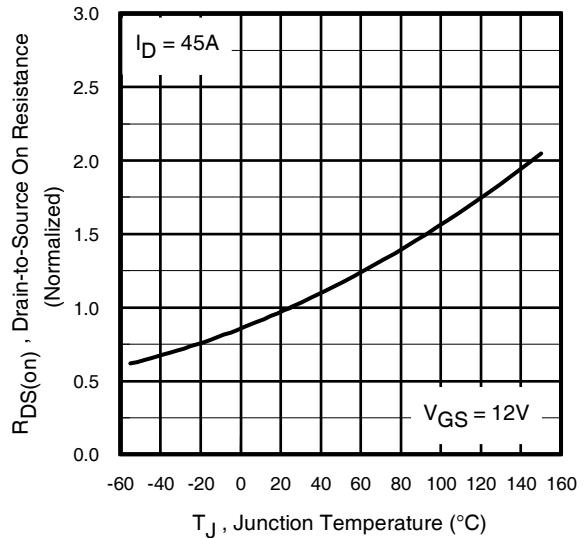
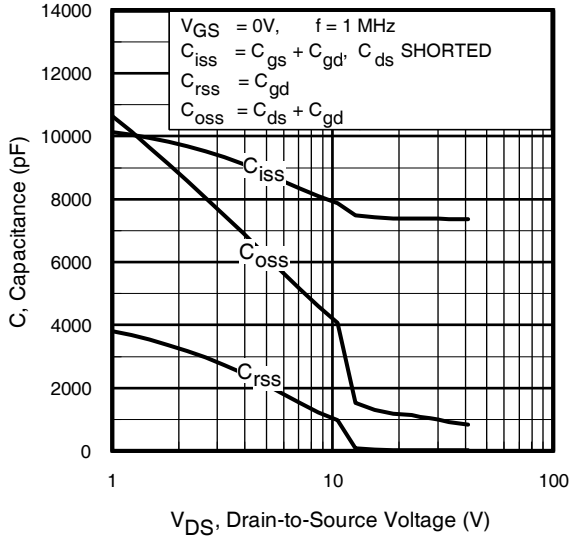
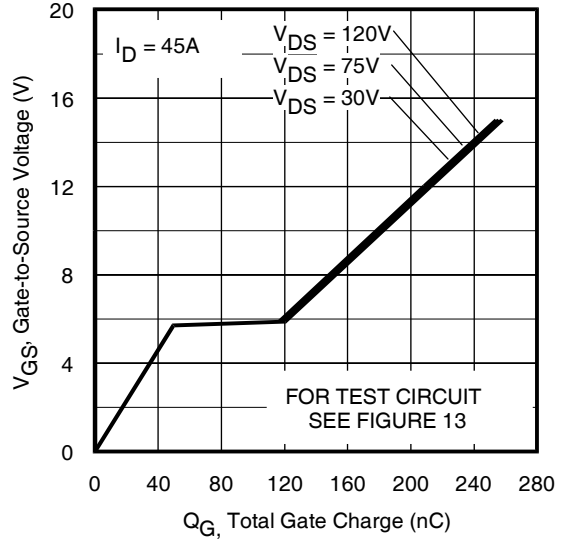

Fig 4. Normalized On-Resistance Vs. Temperature



**Fig 5.** Typical Capacitance Vs. Drain-to-Source Voltage



**Fig 6.** Typical Gate Charge Vs. Gate-to-Source Voltage

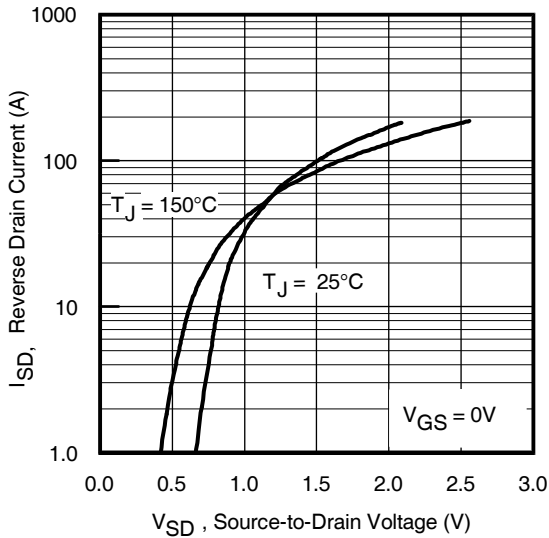

**Fig 7.** Typical Source-Drain Diode Forward Voltage

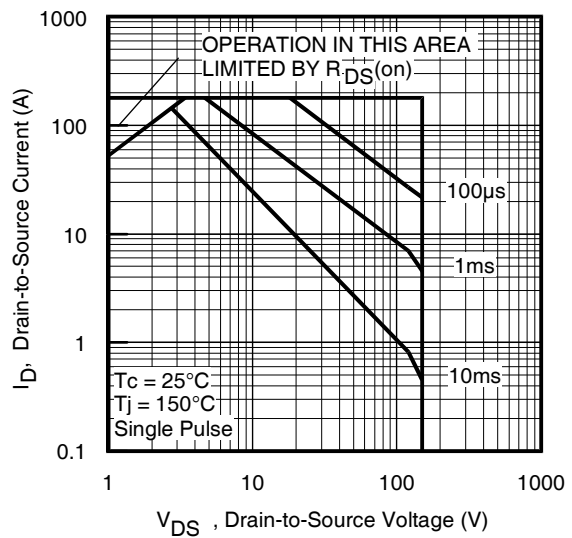

**Fig 8.** Maximum Safe Operating Area

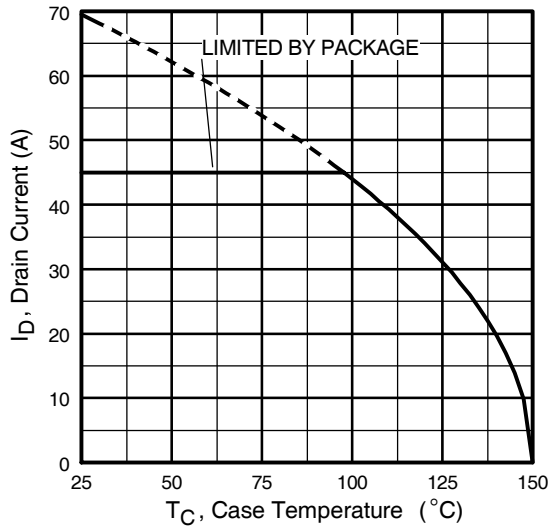

**Fig 9.** Maximum Drain Current Vs. Case Temperature

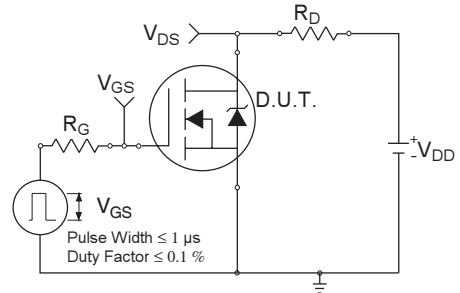

**Fig 10a.** Switching Time Test Circuit

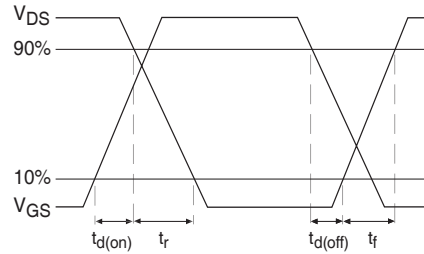

**Fig 10b.** Switching Time Waveforms

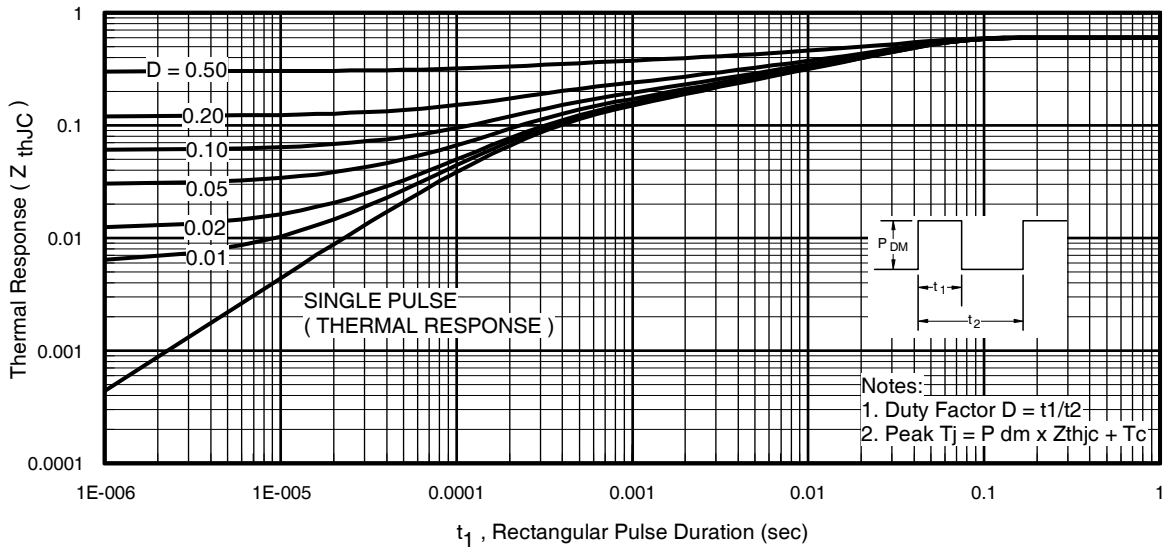

**Fig 11.** Maximum Effective Transient Thermal Impedance, Junction-to-Case

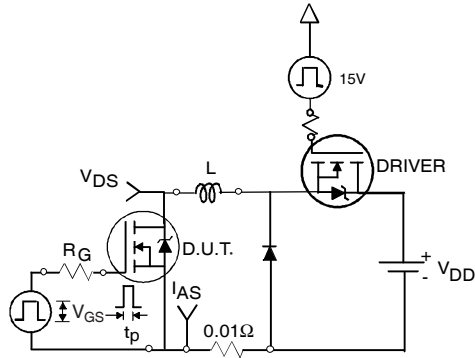

Fig 12a. Unclamped Inductive Test Circuit

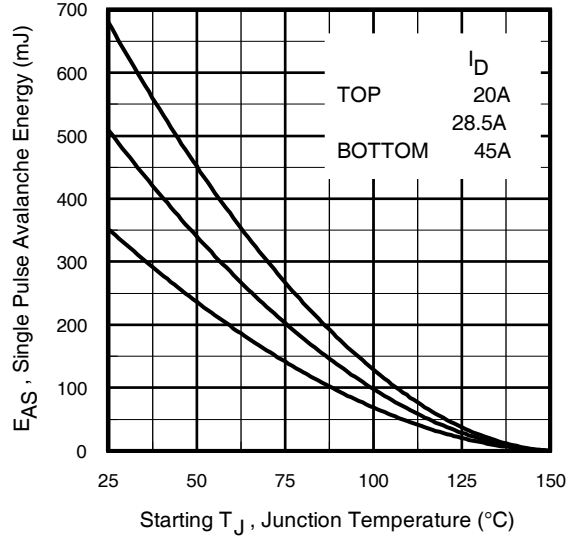

Fig 12c. Maximum Avalanche Energy Vs. Drain Current



Fig 12b. Unclamped Inductive Waveforms

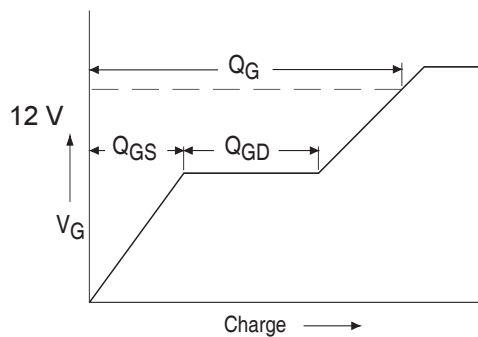

Fig 13a. Basic Gate Charge Waveform

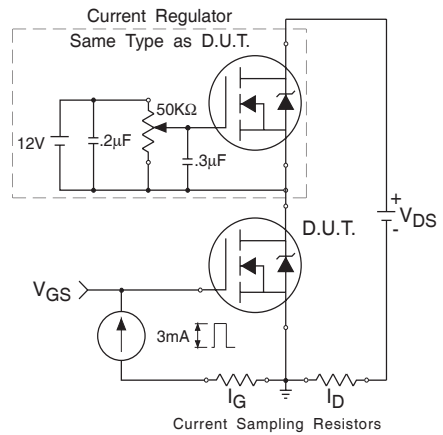

Fig 13b. Gate Charge Test Circuit

**IRHMS67164**

**Pre-Irradiation**

**Footnotes:**

- ① Repetitive Rating; Pulse width limited by maximum junction temperature.
- ②  $V_{DD} = 25V$ , starting  $T_J = 25^\circ C$ ,  $L = 0.35\text{ mH}$   
Peak  $I_L = 45A$ ,  $V_{GS} = 12V$
- ③  $I_{SD} \leq 45A$ ,  $di/dt \leq 940A/\mu s$ ,  
 $V_{DD} \leq 150V$ ,  $T_J \leq 150^\circ C$
- ④ Pulse width  $\leq 300\ \mu s$ ; Duty Cycle  $\leq 2\%$
- ⑤ **Total Dose Irradiation with VGS Bias.**  
12 volt  $V_{GS}$  applied and  $V_{DS} = 0$  during irradiation per MIL-STD-750, method 1019, condition A.
- ⑥ **Total Dose Irradiation with VDS Bias.**  
120 volt  $V_{DS}$  applied and  $V_{GS} = 0$  during irradiation per MIL-STD-750, method 1019, condition A.

**Case Outline and Dimensions — Low-Ohmic TO-254AA**

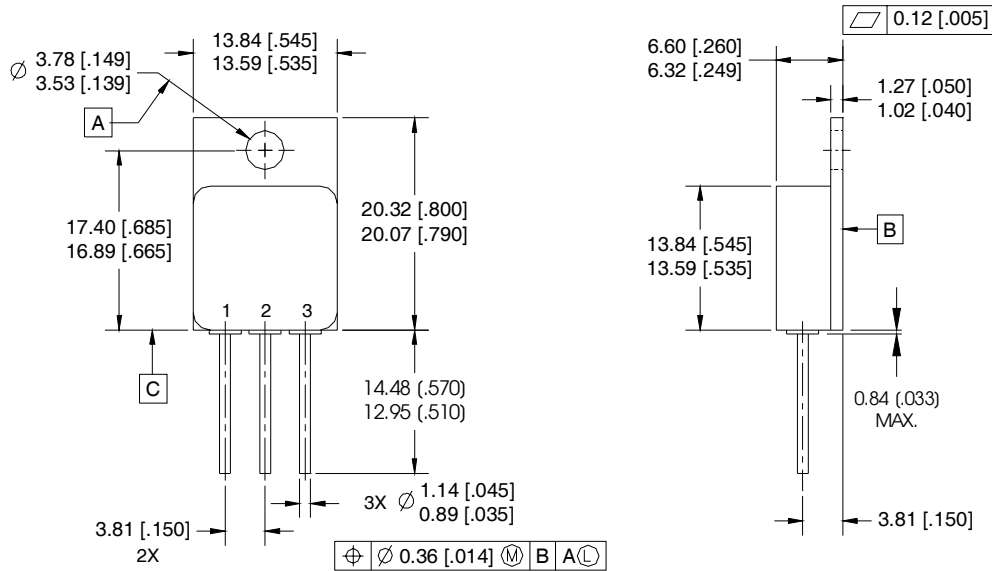

**NOTES:**

1. DIMENSIONING & TOLERANCING PER ASME Y14.5M-1994.
2. ALL DIMENSIONS ARE SHOWN IN MILLIMETERS [INCHES].
3. CONTROLLING DIMENSION: INCH.
4. CONFORMS TO JEDEC OUTLINE TO-254AA.

**PIN ASSIGNMENTS**

- 1 = DRAIN
- 2 = SOURCE
- 3 = GATE

**CAUTION**

**BERYLLIA WARNING PER MIL-PRF-19500**

Package containing beryllia shall not be ground, sandblasted, machined, or have other operations performed on them which will produce beryllia or beryllium dust. Furthermore, beryllium oxide packages shall not be placed in acids that will produce fumes containing beryllium.

International  
**IR** Rectifier

**IR WORLD HEADQUARTERS:** 233 Kansas St., El Segundo, California 90245, USA Tel: (310) 252-7105

**IR LEOMINSTER :** 205 Crawford St., Leominster, Massachusetts 01453, USA Tel: (978) 534-5776

TAC Fax: (310) 252-7903

Visit us at [www.irf.com](http://www.irf.com) for sales contact information.

*Data and specifications subject to change without notice. 12/2005*