

# IRF7379PbF

HEXFET® Power MOSFET

- Generation V Technology
- Ultra Low On-Resistance
- Complimentary Half Bridge
- Surface Mount
- Fully Avalanche Rated
- Lead-Free

## Description

Fifth Generation HEXFETs from International Rectifier utilize advanced processing techniques to achieve extremely low on-resistance per silicon area. This benefit, combined with the fast switching speed and ruggedized device design that HEXFET Power MOSFETs are well known for, provides the designer with an extremely efficient and reliable device for use in a wide variety of applications.

The SO-8 has been modified through a customized leadframe for enhanced thermal characteristics and multiple-die capability making it ideal in a variety of power applications. With these improvements, multiple devices can be used in an application with dramatically reduced board space. The package is designed for vapor phase, infra red, or wave soldering techniques.

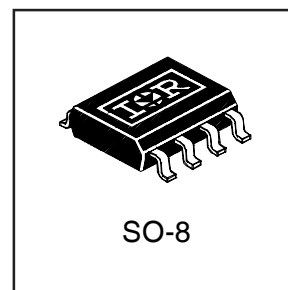
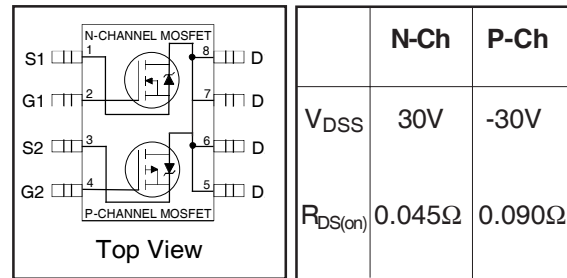

## Absolute Maximum Ratings

	Parameter	Max.		Units
		N-Channel	P-Channel	
$V_{SD}$	Drain-to-Source Voltage	30	-30	A
$I_D @ T_A = 25^\circ\text{C}$	Continuous Drain Current, $V_{GS} @ 10\text{V}$	5.8	-4.3	
$I_D @ T_A = 70^\circ\text{C}$	Continuous Drain Current, $V_{GS} @ 10\text{V}$	4.6	-3.4	
$I_{DM}$	Pulsed Drain Current ①	46	-34	
$P_D @ T_A = 25^\circ\text{C}$	Power Dissipation	2.5		W
	Linear Derating Factor	0.02		W/°C
$V_{GS}$	Gate-to-Source Voltage	± 20		V
dv/dt	Peak Diode Recovery dv/dt ②	5.0	-5.0	V/ns
$T_J, T_{STG}$	Junction and Storage Temperature Range	-55 to + 150		°C

## Thermal Resistance Ratings

	Parameter	Max.	Units
$R_{\theta JA}$	Maximum Junction-to-Ambient③	50	°C/W

www.irf.com

1

## Electrical Characteristics @ T<sub>J</sub> = 25°C (unless otherwise specified)

Parameter	Parameter		Min.	Typ.	Max.	Units	Conditions
V <sub>(BR)DSS</sub>	Drain-to-Source Breakdown Voltage	N-Ch	30	—	—	V	V <sub>GS</sub> = 0V, I <sub>D</sub> = 250μA
		P-Ch	-30	—	—		V <sub>GS</sub> = 0V, I <sub>D</sub> = -250μA
ΔV <sub>(BR)DSS</sub> /ΔT <sub>J</sub>	Breakdown Voltage Temp. Coefficient	N-Ch	—	0.032	—	V/°C	Reference to 25°C, I <sub>D</sub> = 1mA
		P-Ch	—	-0.037	—		Reference to 25°C, I <sub>D</sub> = -1mA
R <sub>DS(ON)</sub>	Static Drain-to-Source On-Resistance	N-Ch	—	0.038	0.045	Ω	V <sub>GS</sub> = 10V, I <sub>D</sub> = 5.8A ③
			—	0.055	0.075		V <sub>GS</sub> = 4.5V, I <sub>D</sub> = 4.9A ③
		P-Ch	—	0.070	0.090		V <sub>GS</sub> = -10V, I <sub>D</sub> = -4.3A ③
			—	0.130	0.180		V <sub>GS</sub> = -4.5V, I <sub>D</sub> = -3.7A ③
V <sub>GS(th)</sub>	Gate Threshold Voltage	N-Ch	1.0	—	—	V	V <sub>DS</sub> = V <sub>GS</sub> , I <sub>D</sub> = 250μA
		P-Ch	-1.0	—	—		V <sub>DS</sub> = V <sub>GS</sub> , I <sub>D</sub> = -250μA
g <sub>fs</sub>	Forward Transconductance	N-Ch	5.2	—	—	S	V <sub>DS</sub> = 15V, I <sub>D</sub> = 2.4A ③
		P-Ch	2.5	—	—		V <sub>DS</sub> = -24V, I <sub>D</sub> = -1.8A ③
I <sub>DSS</sub>	Drain-to-Source Leakage Current	N-Ch	—	—	1.0	μA	V <sub>DS</sub> = 24V, V <sub>GS</sub> = 0V
		P-Ch	—	—	-1.0		V <sub>DS</sub> = -24V, V <sub>GS</sub> = 0V
		N-Ch	—	—	25		V <sub>DS</sub> = 24V, V <sub>GS</sub> = 0V, T <sub>J</sub> = 125°C
		P-Ch	—	—	-25		V <sub>DS</sub> = -24V, V <sub>GS</sub> = 0V, T <sub>J</sub> = 125°C
I <sub>GSS</sub>	Gate-to-Source Forward Leakage	N-P	—	—	±100	μA	V <sub>GS</sub> = ±20V
Q <sub>g</sub>	Total Gate Charge	N-Ch	—	—	25	nC	N-Channel I <sub>D</sub> = 2.4A, V <sub>DS</sub> = 24V, V <sub>GS</sub> = 10V ③
		P-Ch	—	—	25		
Q <sub>gs</sub>	Gate-to-Source Charge	N-Ch	—	—	2.9	nC	P-Channel I <sub>D</sub> = -1.8A, V <sub>DS</sub> = -24V, V <sub>GS</sub> = -10V ③
		P-Ch	—	—	2.9		
Q <sub>gd</sub>	Gate-to-Drain ("Miller") Charge	N-Ch	—	—	7.9	nC	P-Channel I <sub>D</sub> = -1.8A, V <sub>DS</sub> = -24V, V <sub>GS</sub> = -10V ③
		P-Ch	—	—	9.0		
t <sub>d(on)</sub>	Turn-On Delay Time	N-Ch	—	6.8	—	ns	N-Channel V <sub>DD</sub> = 15V, I <sub>D</sub> = 2.4A, R <sub>G</sub> = 6.0Ω, R <sub>D</sub> = 6.2Ω ③
		P-Ch	—	11	—		
t <sub>r</sub>	Rise Time	N-Ch	—	21	—	ns	P-Channel V <sub>DD</sub> = -15V, I <sub>D</sub> = -1.8A, R <sub>G</sub> = 6.0Ω, R <sub>D</sub> = 8.2Ω ③
		P-Ch	—	17	—		
t <sub>d(off)</sub>	Turn-Off Delay Time	N-Ch	—	22	—	ns	P-Channel V <sub>DD</sub> = -15V, I <sub>D</sub> = -1.8A, R <sub>G</sub> = 6.0Ω, R <sub>D</sub> = 8.2Ω ③
		P-Ch	—	25	—		
t <sub>f</sub>	Fall Time	N-Ch	—	7.7	—	ns	P-Channel V <sub>DD</sub> = -15V, I <sub>D</sub> = -1.8A, R <sub>G</sub> = 6.0Ω, R <sub>D</sub> = 8.2Ω ③
		P-Ch	—	18	—		
L <sub>D</sub>	Internal Drain Inductance	N-P	—	4.0	—	nH	Between lead, 6mm (0.25in.) from package and center of die contact
L <sub>S</sub>	Internal Source Inductance	N-P	—	6.0	—		
C <sub>iss</sub>	Input Capacitance	N-Ch	—	520	—	pF	N-Channel V <sub>GS</sub> = 0V, V <sub>DS</sub> = 25V, f = 1.0MHz ③
		P-Ch	—	440	—		
C <sub>oss</sub>	Output Capacitance	N-Ch	—	180	—	pF	P-Channel V <sub>GS</sub> = 0V, V <sub>DS</sub> = -25V, f = 1.0MHz ③
		P-Ch	—	200	—		
C <sub>rss</sub>	Reverse Transfer Capacitance	N-Ch	—	72	—	pF	P-Channel V <sub>GS</sub> = 0V, V <sub>DS</sub> = -25V, f = 1.0MHz ③
		P-Ch	—	93	—		

## Source-Drain Ratings and Characteristics

Parameter	Parameter		Min.	Typ.	Max.	Units	Conditions
I <sub>S</sub>	Continuous Source Current (Body Diode)	N-Ch	—	—	3.1	A	
		P-Ch	—	—	-3.1		
I <sub>SM</sub>	Pulsed Source Current (Body Diode) ①	N-Ch	—	—	46	A	
		P-Ch	—	—	-34		
V <sub>SD</sub>	Diode Forward Voltage	N-Ch	—	—	1.0	V	T <sub>J</sub> = 25°C, I <sub>S</sub> = 1.8A, V <sub>GS</sub> = 0V ③
		P-Ch	—	—	-1.0		T <sub>J</sub> = 25°C, I <sub>S</sub> = -1.8A, V <sub>GS</sub> = 0V ③
t <sub>rr</sub>	Reverse Recovery Time	N-Ch	—	47	71	ns	N-Channel T <sub>J</sub> = 25°C, I <sub>F</sub> = 2.4A, di/dt = 100A/μs ③
		P-Ch	—	53	80		
Q <sub>rr</sub>	Reverse Recovery Charge	N-Ch	—	56	84	nC	P-Channel T <sub>J</sub> = 25°C, I <sub>F</sub> = -1.8A, di/dt = -100A/μs ③
		P-Ch	—	66	99		

### Notes:

- ① Repetitive rating; pulse width limited by max. junction temperature. ( See fig. 10 )
- ② N-Channel I<sub>SD</sub> ≤ 2.4A, di/dt ≤ 73A/μs, V<sub>DD</sub> ≤ V<sub>(BR)DSS</sub>, T<sub>J</sub> ≤ 150°C  
P-Channel I<sub>SD</sub> ≤ -1.8A, di/dt ≤ 90A/μs, V<sub>DD</sub> ≤ V<sub>(BR)DSS</sub>, T<sub>J</sub> ≤ 150°C
- ③ Pulse width ≤ 300μs; duty cycle ≤ 2%.
- ④ Surface mounted on FR-4 board, t ≤ 10sec.

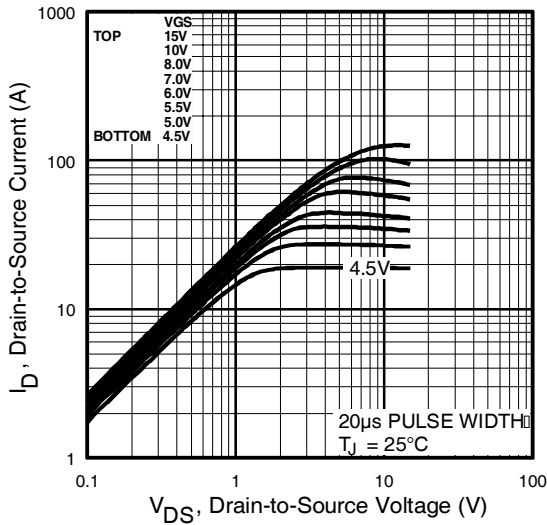

Fig 1. Typical Output Characteristics

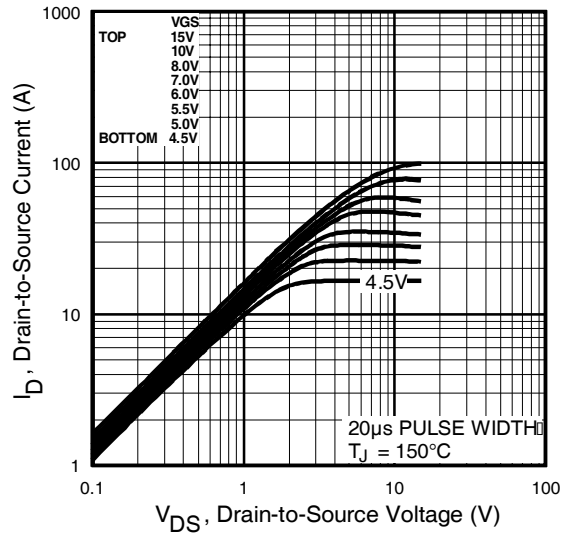

Fig 2. Typical Output Characteristics

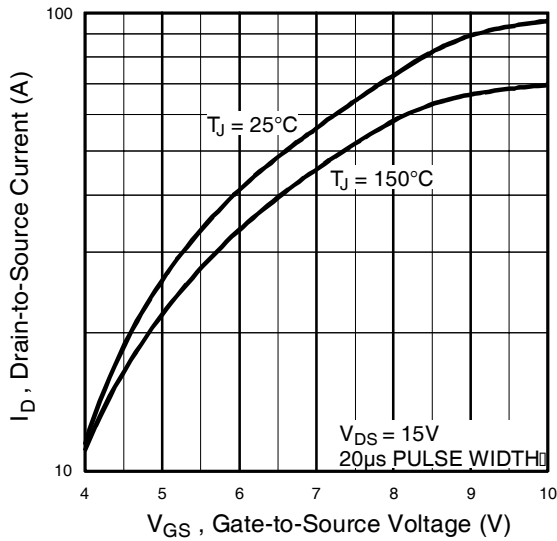

Fig 3. Typical Transfer Characteristics

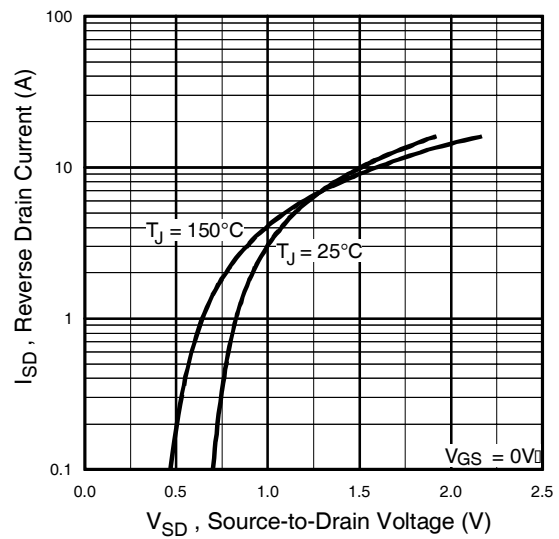
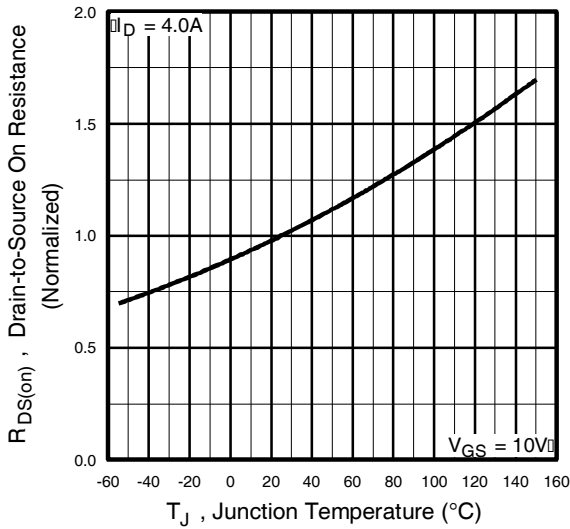
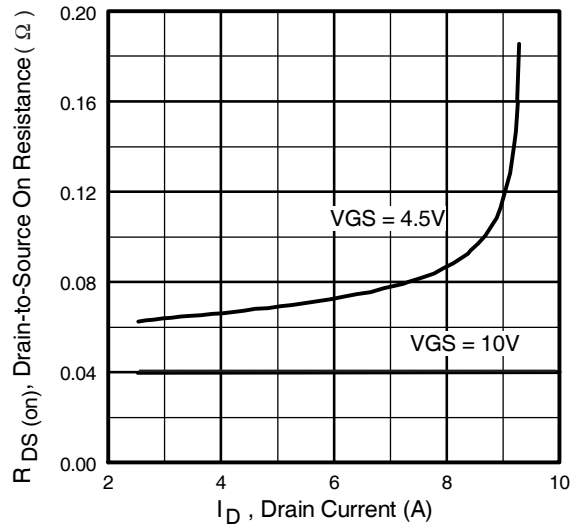

Fig 4. Typical Source-Drain Diode Forward Voltage



**Fig 5.** Normalized On-Resistance Vs. Temperature



**Fig 6.** Typical On-Resistance Vs. Drain Current

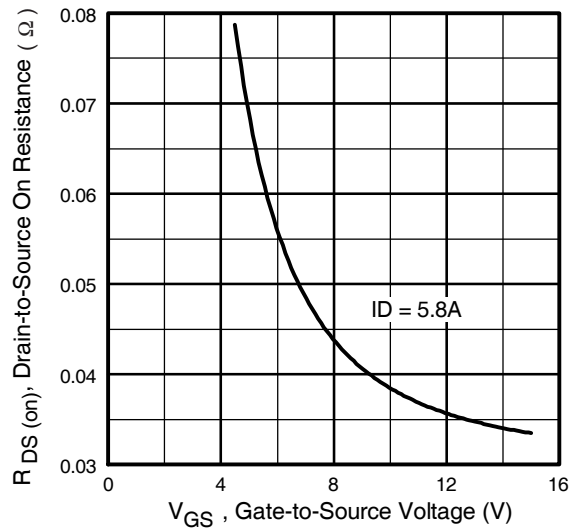

**Fig 7.** Typical On-Resistance Vs. Gate Voltage

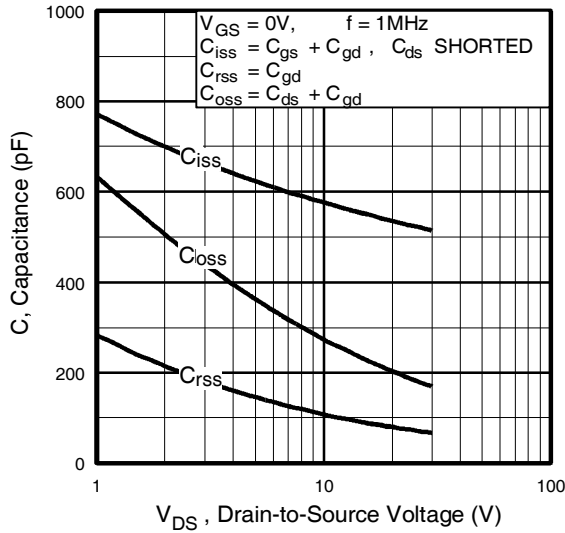

Fig 8. Typical Capacitance Vs. Drain-to-Source Voltage

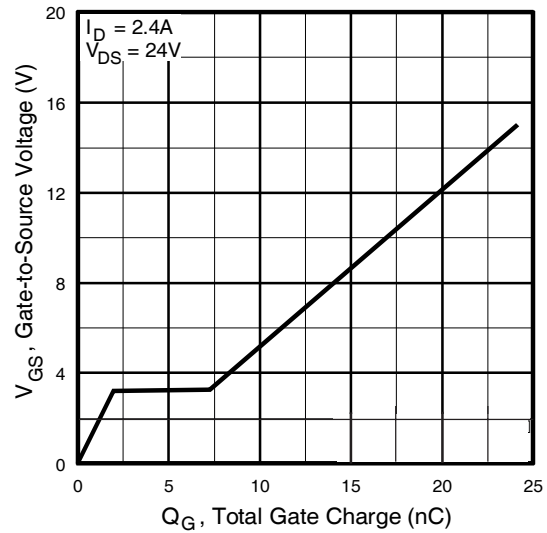

Fig 9. Typical Gate Charge Vs. Gate-to-Source Voltage

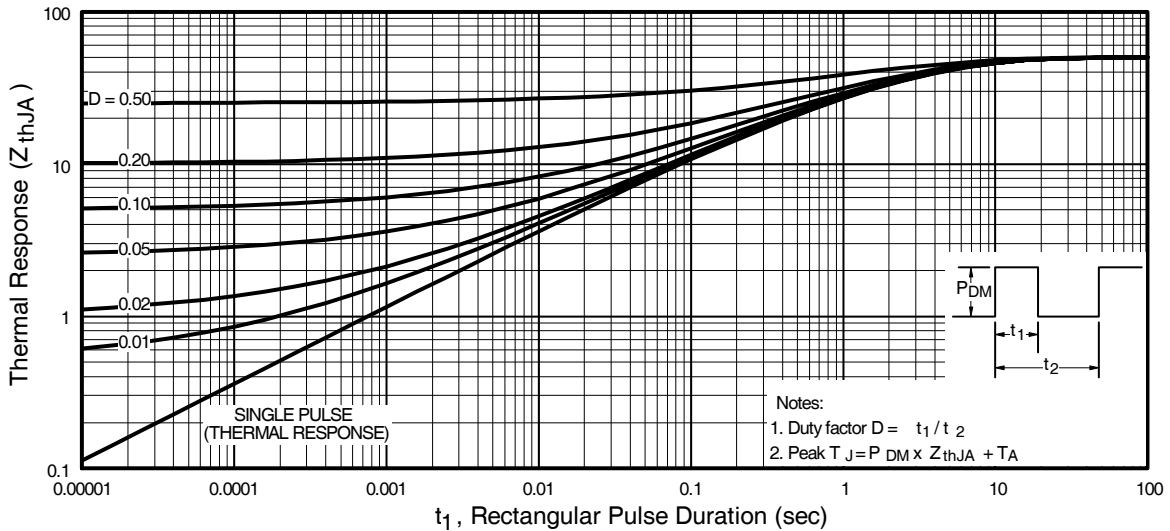
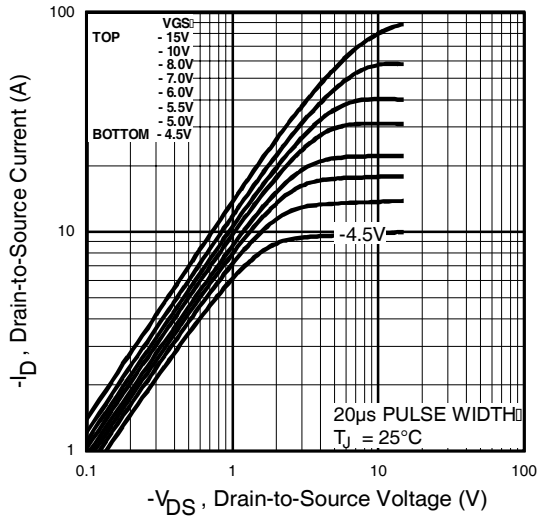
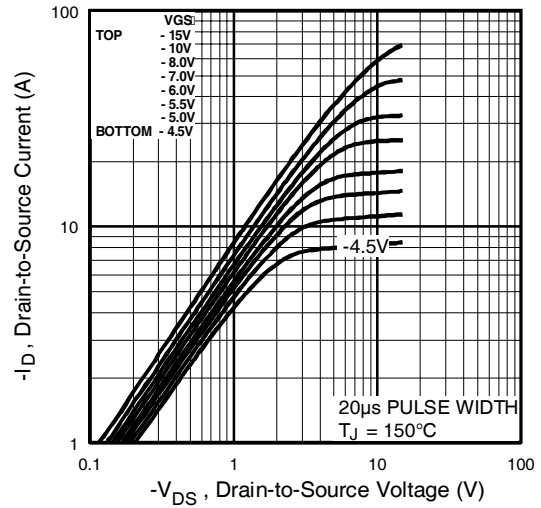

Fig 10. Maximum Effective Transient Thermal Impedance, Junction-to-Ambient



**Fig 11.** Typical Output Characteristics



**Fig 12.** Typical Output Characteristics

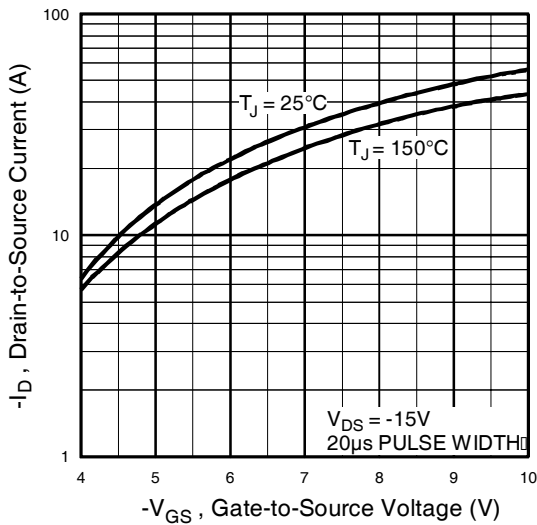

**Fig 13.** Typical Transfer Characteristics

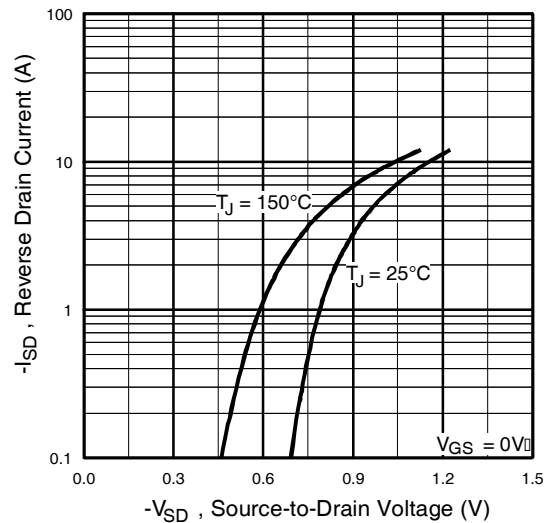

**Fig 14.** Typical Source-Drain Diode Forward Voltage

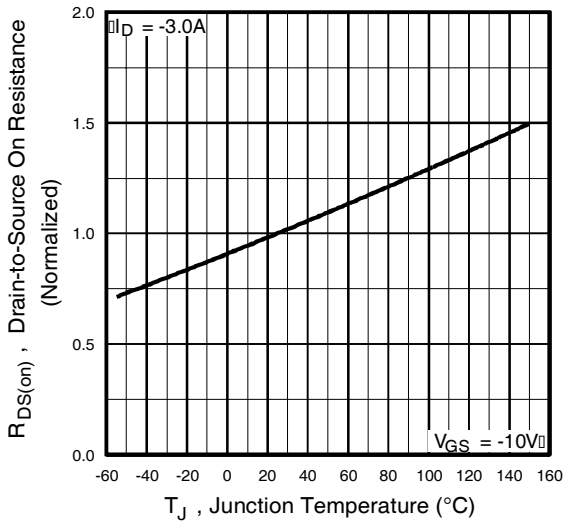

Fig 15. Normalized On-Resistance Vs. Temperature

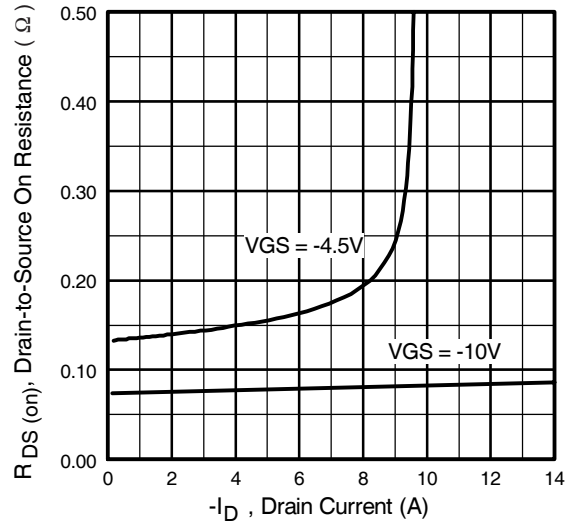

Fig 16. Typical On-Resistance Vs. Drain Current

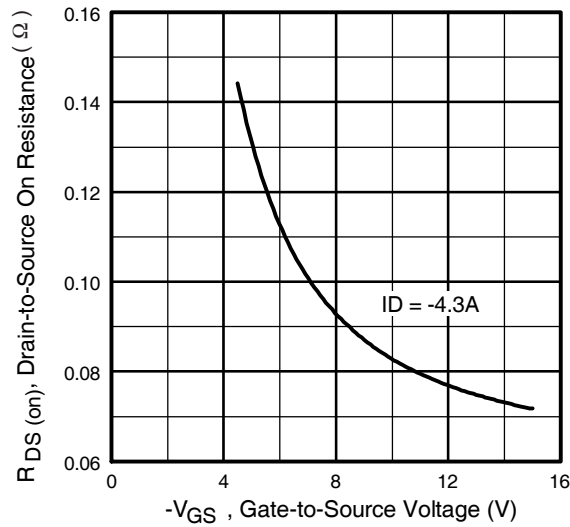
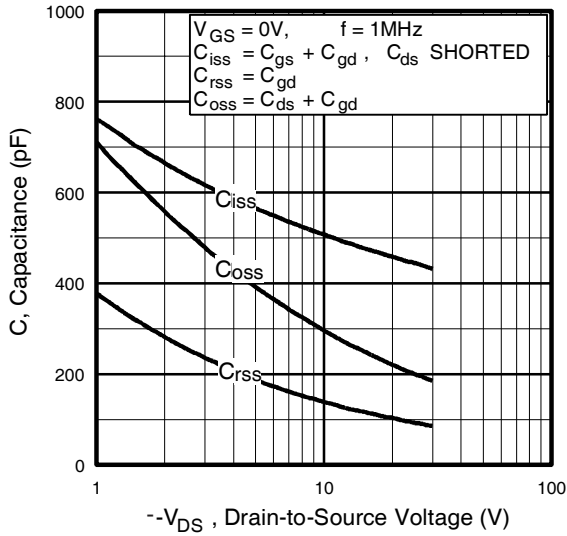

Fig 17. Typical On-Resistance Vs. Gate Voltage

# IRF7379PbF

P-Channel

International  
**IR** Rectifier



**Fig 18.** Typical Capacitance Vs. Drain-to-Source Voltage

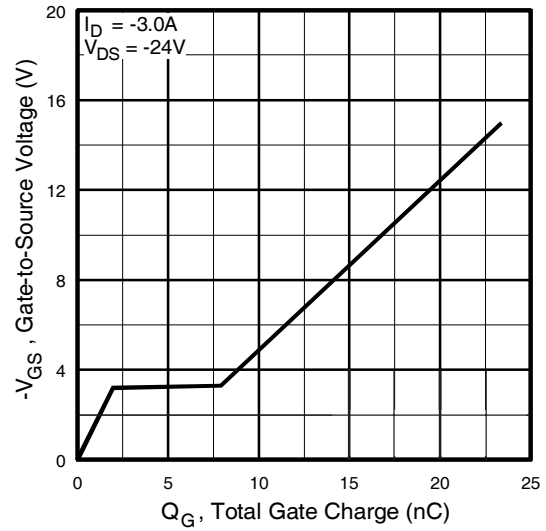

**Fig 19.** Typical Gate Charge Vs. Gate-to-Source Voltage

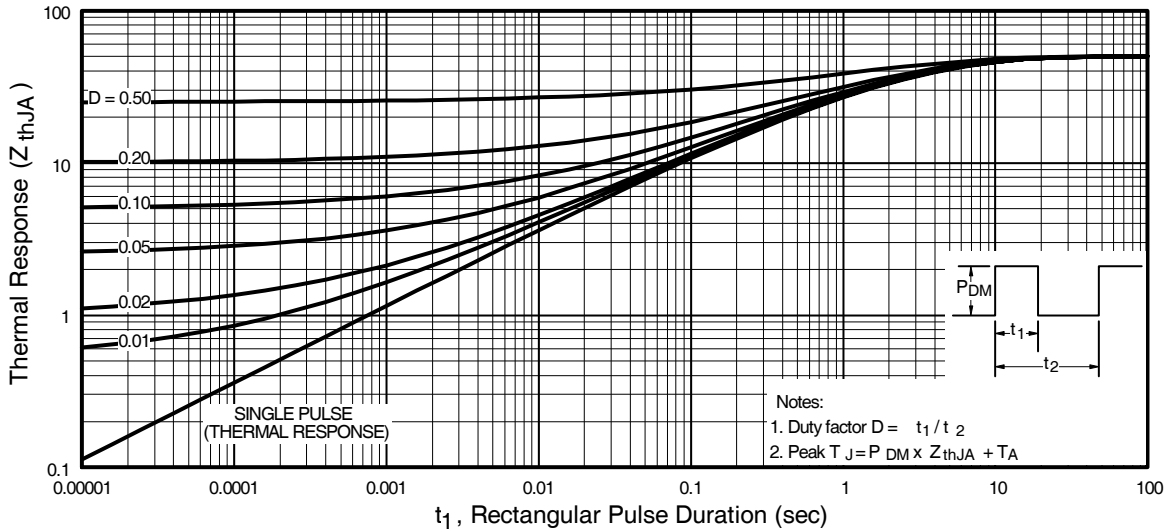
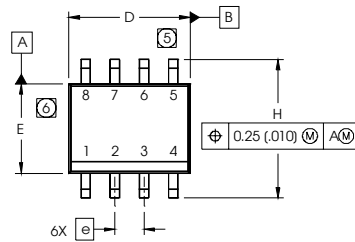

**Fig 20.** Maximum Effective Transient Thermal Impedance, Junction-to-Ambient



## SO-8 Package Outline

Dimensions are shown in millimeters (inches)



DIM	INCHES		MILLIMETERS	
	MIN	MAX	MIN	MAX
A	.0532	.0688	1.35	1.75
A1	.0040	.0098	0.10	0.25
b	.013	.020	0.33	0.51
c	.0075	.0098	0.19	0.25
D	.189	.1968	4.80	5.00
E	.1497	.1574	3.80	4.00
e	.050 BASIC		1.27 BASIC	
e1	.025 BASIC		0.635 BASIC	
H	.2284	.2440	5.80	6.20
K	.0099	.0196	0.25	0.50
L	.016	.050	0.40	1.27
y	0°	8°	0°	8°

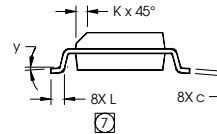
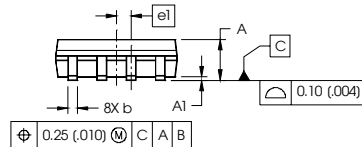

- NOTES:
1. DIMENSIONING & TOLERANCING PER ASME Y14.5M-1994.
  2. CONTROLLING DIMENSION: MILLIMETER
  3. DIMENSIONS ARE SHOWN IN MILLIMETERS (INCHES).
  4. OUTLINE CONFORMS TO JEDEC OUTLINE MS-012AA.
- ⑤ DIMENSION DOES NOT INCLUDE MOLD PROTRUSIONS. MOLD PROTRUSIONS NOT TO EXCEED 0.15 (.006).
- ⑥ DIMENSION DOES NOT INCLUDE MOLD PROTRUSIONS. MOLD PROTRUSIONS NOT TO EXCEED 0.25 (.010).
- ⑦ DIMENSION IS THE LENGTH OF LEAD FOR SOLDERING TO A SUBSTRATE.

### FOOTPRINT

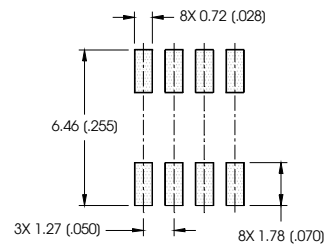

## SO-8 Part Marking Information (Lead-Free)

EXAMPLE: THIS IS AN IRF7101 (MOSFET)

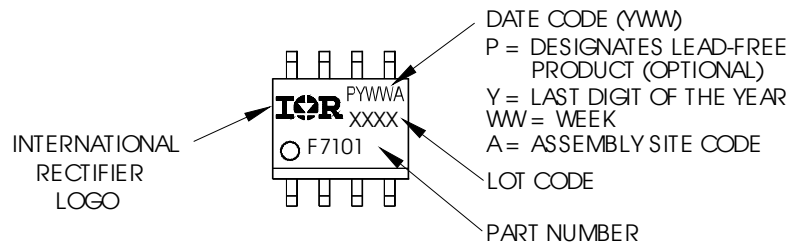

# IRF7379PbF

International  
**IR** Rectifier

## SO-8 Tape and Reel

Dimensions are shown in millimeters (inches)

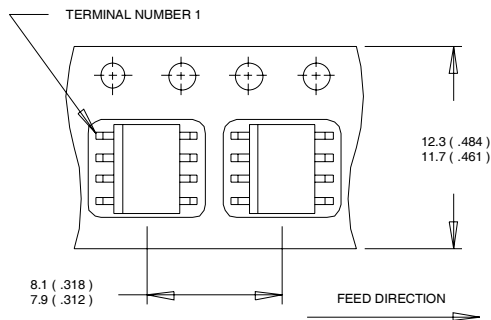

NOTES:

1. CONTROLLING DIMENSION : MILLIMETER.
2. ALL DIMENSIONS ARE SHOWN IN MILLIMETERS(INCHES).
3. OUTLINE CONFORMS TO EIA-481 & EIA-541.

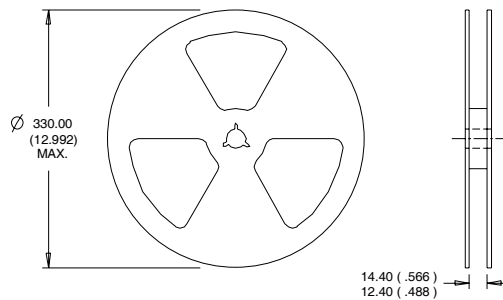

NOTES:

1. CONTROLLING DIMENSION : MILLIMETER.
2. OUTLINE CONFORMS TO EIA-481 & EIA-541.

Data and specifications subject to change without notice.  
This product has been designed and qualified for the Consumer market.  
Qualifications Standards can be found on IR's Web site.

International  
**IR** Rectifier

IR WORLD HEADQUARTERS: 233 Kansas St., El Segundo, California 90245, USA Tel: (310) 252-7105  
TAC Fax: (310) 252-7903

Visit us at [www.irf.com](http://www.irf.com) for sales contact information.10/04

[www.irf.com](http://www.irf.com)