

IN74LS04

Hex Inverters

This device contains six independent inverters. It performs the Boolean function $Y = \overline{A}$.

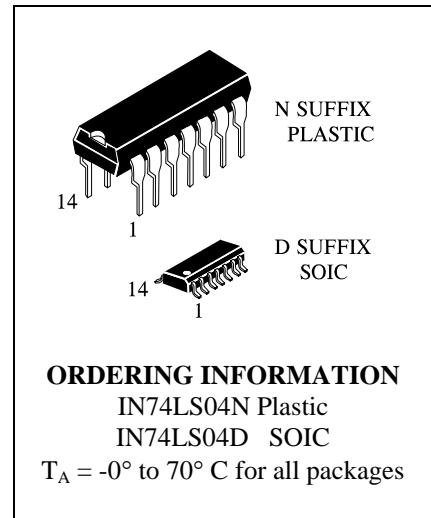

LOGIC DIAGRAM

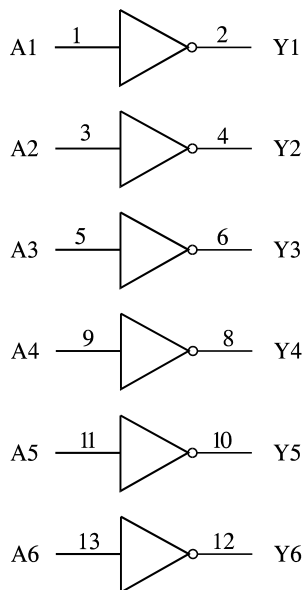

PIN 14 = V_{CC}
 PIN 7 = GND

PIN ASSIGNMENT

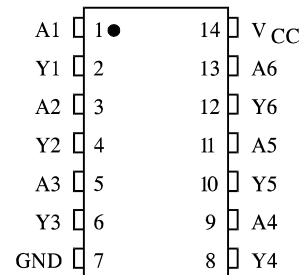

FUNCTION TABLE

Inputs	Output
A	Y
H	L
L	H

MAXIMUM RATINGS*

Symbol	Parameter	Value	Unit
V _{CC}	Supply Voltage	7.0	V
V _{IN}	Input Voltage	7.0	V
V _{OUT}	Output Voltage	7.0	V
T _{stg}	Storage Temperature Range	-65 to +150	°C

*Maximum Ratings are those values beyond which damage to the device may occur. Functional operation should be restricted to the Recommended Operating Conditions.

RECOMMENDED OPERATING CONDITIONS

Symbol	Parameter	Min	Max	Unit
V _{CC}	Supply Voltage	4.75	5.25	V
I _{OH}	High Level Output Current		-400	V
I _{OL}	Low Level Output Current		8.0	V
T _A	Ambient Temperature Range	0	+70	°C

DC ELECTRICAL CHARACTERISTICS over full operating conditions

Symbol	Parameter	Test Conditions	Guaranteed Limit		Unit
			Min	Max	
V _{IH}	High Level Input Voltage		2		V
V _{IL}	Low Level Input Voltage			0.8	V
V _{IK}	Input Clamp Voltage	V _{CC} = min, I _I = -18 mA		-1.5	V
V _{OH}	High Level Output Current	V _{CC} = min, V _{IL} = max I _{OH} = max	2.7		V
V _{OL}	Low Level Output Voltage	V _{CC} = min, V _{IH} = min, I _{OL} = 8 mA		0.5	V
I _I	Input Current at maximum input voltage	V _{CC} = max, V _I = -7V		0.1	mA
I _{IH}	High Level Input Current	V _{CC} = max, V _{IN} = 2.7 V		20	μA
I _{IL}	Low Level Input Current	V _{CC} = max, V _{IN} = 0.4 V		-0.4	mA
I _{OS}	Short-circuit output current	V _{CC} = max (Note)	-20	-100	mA
I _{CC}	Supply Current	V _{CC} = max	Total with outputs high	2.4	mA
			Total with outputs low	6.6	

Note: Not more than one output should be shorted at a time, and duration should not exceed one second.

AC ELECTRICAL CHARACTERISTICS ($V_{CC} = 5.0\text{ V}$, $C_L = 15\text{ pF}$, $T_A = 25\text{ }^\circ\text{C}$, $R_L = 2\text{ k}\Omega$, $t_r = 15\text{ ns}$, $t_f = 6.0\text{ ns}$)

Symbol	Parameter	Min	Max	Unit
t_{PLH}	Propagation Delay Time		15	ns
t_{PHL}	Propagation Delay Time		15	ns

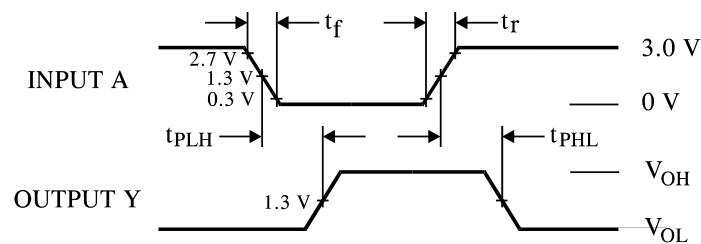
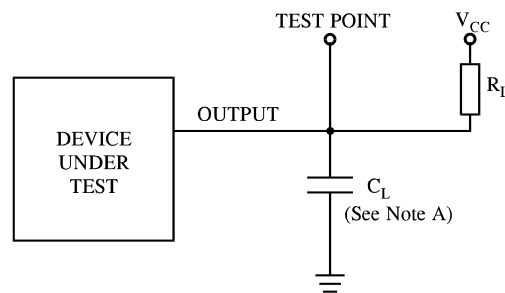

Figure 1. Switching Waveforms



NOTE A. C_L includes probe and jig capacitance.

Figure 2. Test Circuit

**N SUFFIX PLASTIC DIP
(MS - 001AA)**

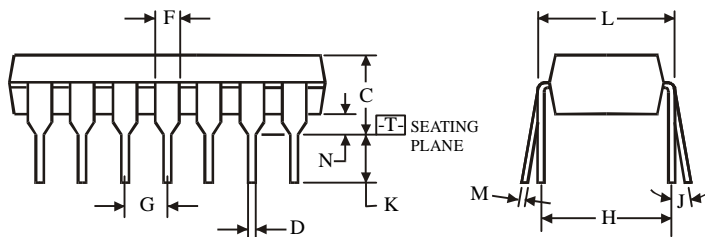
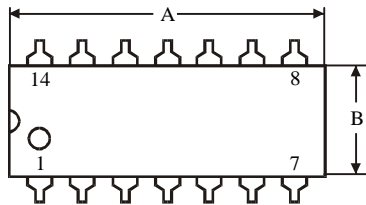
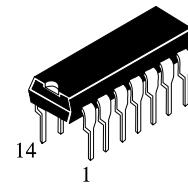

$$\oplus 0.25 (0.010) \text{ (M) T}$$

NOTES:

- Dimensions "A", "B" do not include mold flash or protrusions.
Maximum mold flash or protrusions 0.25 mm (0.010) per side.

Symbol	Dimension, mm	
	MIN	MAX
A	18.67	19.69
B	6.1	7.11
C		5.33
D	0.36	0.56
F	1.14	1.78
G	2.54	
H	7.62	
J	0°	10°
K	2.92	3.81
L	7.62	8.26
M	0.2	0.36
N	0.38	

**D SUFFIX SOIC
(MS - 012AB)**

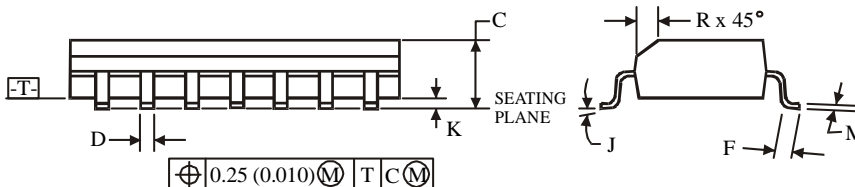
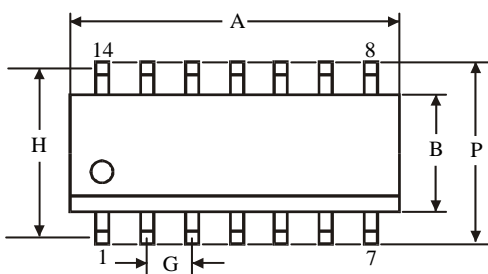
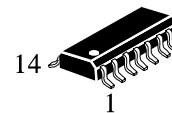

$$\oplus 0.25 (0.010) \text{ (M) T C (M)}$$

NOTES:

- Dimensions A and B do not include mold flash or protrusion.
- Maximum mold flash or protrusion 0.15 mm (0.006) per side for A; for B - 0.25 mm (0.010) per side.

Symbol	Dimension, mm	
	MIN	MAX
A	8.55	8.75
B	3.8	4
C	1.35	1.75
D	0.33	0.51
F	0.4	1.27
G	1.27	
H	5.27	
J	0°	8°
K	0.1	0.25
M	0.19	0.25
P	5.8	6.2
R	0.25	0.5