

REFERENCE

PREPARED BY: <i>K. Marimoto</i>	DATE: <i>Feb. 1. 2000</i>	SHARP ELECTRONIC COMPONENTS GROUP SHARP CORPORATION SPECIFICATION	SPEC. No. <i>ED-00013</i>
APPROVED BY: <i>Y. Yuki</i>	DATE: <i>Feb 1. 2000</i>		ISSUE <i>February 1, 2000</i>
			PAGE <i>21 Pages</i>
			REPRESENTATIVE DIVISION OPTO-ELECTRONIC DEVICES DIV.

DEVICE SPECIFICATION FOR

OPTICAL DATA COMMUNICATION TRANSCEIVER

MODEL No. **GP2W1001YP**

- These specification sheets include materials protected under copyright of Sharp Corporation ("Sharp"). Please do not reproduce or cause anyone to reproduce them without Sharp's consent.
- When using this product, please observe the absolute maximum ratings and the instructions for use outlined in these specification sheets, as well as the precautions mentioned below. Sharp assumes no responsibility for any damage resulting from use of the product which does not comply with the absolute maximum ratings and the instructions included in these specification sheets, and the precautions mentioned below.

(Precautions)

 - This product is designed for use in the following application areas ;
 - OA equipment • Audio visual equipment • Home appliances
 - Telecommunication equipment (Terminal) • Measuring equipment
 - Tooling machines • Computers

If the use of the product in the above application areas is for equipment listed in paragraphs (2) or (3), please be sure to observe the precautions given in those respective paragraphs.
 - Appropriate measures, such as fail-safe design and redundant design considering the safety design of the overall system and equipment, should be taken to ensure reliability and safety when this product is used for equipment which demands high reliability and safety in function and precision, such as ;
 - Transportation control and safety equipment (aircraft, train, automobile etc.)
 - Traffic signals • Gas leakage sensor breakers • Rescue and security equipment
 - Other safety equipment
 - Please do not use this product for equipment which require extremely high reliability and safety in function and precision, such as ;
 - Space equipment • Telecommunication equipment (for trunk lines)
 - Nuclear power control equipment • Medical equipment
 - Please contact and consult with a Sharp sales representative if there are any questions regarding interpretation of the above three paragraphs.
- Please contact and consult with a Sharp sales representative for any questions about this product.

CUSTOMER'S APPROVAL

DATE _____

BY _____

DATE *Feb. 3, 2000*
PRESENTED BY *O. Ichikawa*

O. Ichikawa,
Department General Manager of
Engineering Dept., V
Opto-Electronic Devices Div.
ELECOM Group
SHARP CORPORATION

ED-00013	February 1, 2000
MODEL No. GP2W1001YP	PAGE 1/14

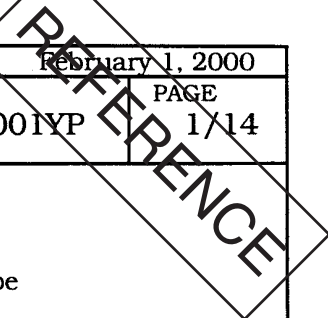

1. Application

This specification applies to the outline and characteristics of IrDA1.1 type Optical Data communication transceiver, Model No. GP2W1001YP.

2. Outline

Refer to the attached sheet, page 6.

3. Ratings and characteristics

Refer to the attached sheet, page 7 to 12.

4. Reliability

Refer to the attached sheet, page 13.

5. Outgoing inspection

Refer to the attached sheet, page 14.

6. Supplement

- 1) This product is built-in photodiode.
- 2) Product mass (Piece) : Approximately 0.15g
- 3) ODS materials

This product shall not contain the following materials.
Also, the following materials shall not be used in the production process for this product.

Materials for ODS : CFC_s, Halon, Carbon tetrachloride,
1.1.1-Trichloroethane (Methylchloroform)

4) Brominated flame retardants

Specific brominated flame retardants such as the PBBO_s and PBB_s are not used in this device at all.

5) Packing

Refer to the attached sheet-3.

- Product mass at 8000pcs./package : Approximately 3.3kg

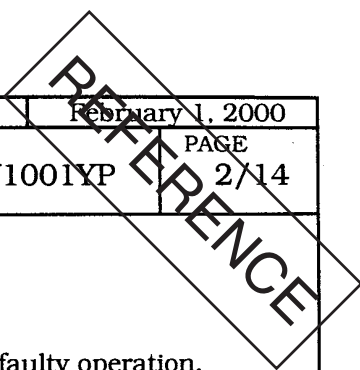

7. Notes

1) If the surface of detector is smeared with dust or dirt, it may cause faulty operation. Caution shall be taken to avoid this. And do not touch the detector surface.

2) Cleaning conditions :

Solvent cleaning : Solvent temperature 45°C or less
Immersion for 3 min or less

Ultrasonic cleaning : The effect to device by ultrasonic cleaning differs by cleaning bath size, ultrasonic power output, cleaning time, PCB size or device mounting condition etc. Please test it in actual using condition and confirm that doesn't occur any defect before starting the ultrasonic cleaning.

The cleaning shall be carried out with solvent below.

Solvent : Ethyl alcohol, Methyl alcohol, Isopropyl alcohol

3) In order to prevent electrostatic discharge of integrated circuit, human body and soldering iron, etc. shall be grounded.

4) In case that things touch to the device after mounting, such external force is applied to the device, there is possibility to be caused the mounting defect such as terminal coming off. Please be careful for handling.

5) Precautions for Soldering

Refer to the attached sheet-1.

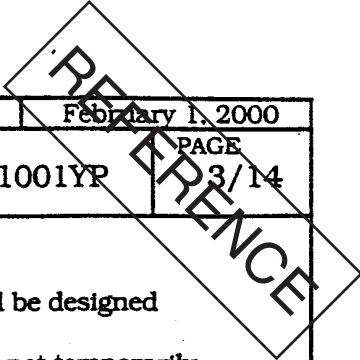

- 6) When the system (program) is designed, the Turn Around Time shall be designed by considering 0.5ms or more that is specified by IrDA.
Then, this Turn Around Time means the time when this device does not temporarily defect the signal light, since the transmitted light from the transceiver reaches the detector side of the same transceiver.
- 7) As it is necessary 1.5ms or more (at Ta=25°C) to return from shut-down mode to ready-operation mode, please consider this point at the system (program) designing. Also, please confirm thoroughly the operation in accrual application.
- 8) When there is much external disturbing light or the light source is located near this transceiver and the detector face receives much external disturbing light, there is a case that the pulse other than signal output is generated as noise on output terminal of this transceiver. Please consider the lay-out and structure to reduce disturbing light on the detector face.
- 9) In case that this sensor is adopted in IR communication system, please use it according to the signal method which is specified by [Serial Infrared Physical Layer Link Specification Version 1.1] published by the Infrared Data Association. Faulty operation may happen, if different signal method than specified one is used.
- 10) Recommended external circuit

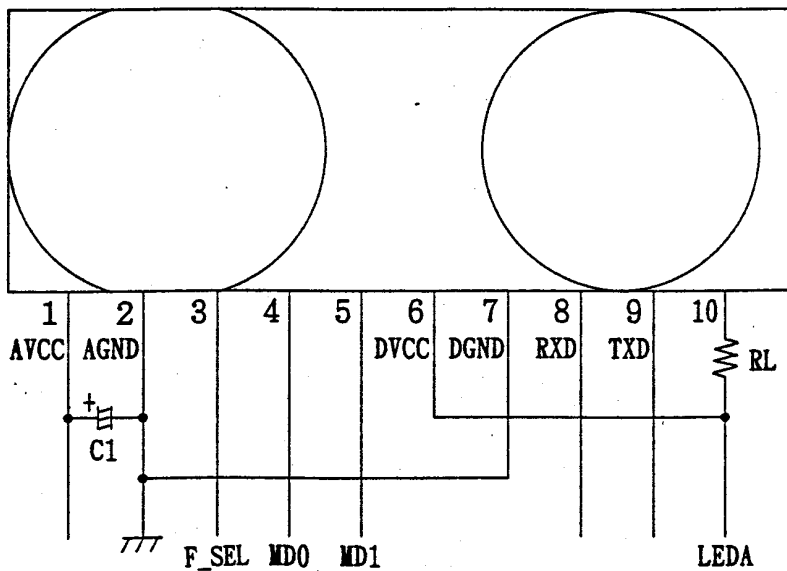

Components	Recommended values
C1	4.7 μ F \pm 10% (Note)
RL	2.4 Ω \pm 5% 1/2W (Vcc=3.3V)
	6.8 Ω \pm 5% 1/2W (Vcc=5.0V)

(Note) Please choose the most suitable CX according to the noise level and noise frequency of power supply.

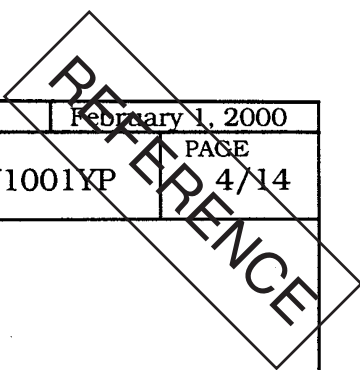

11) Truth table

Input		Output	
TXD (Transceiver)	Receiver	LED (Emitter)	RXD
High	-	ON	X
Low	ON	OFF	Low
Low	OFF	OFF	High

X : Do not care

12) Input-output logic table

MD0	MD1	F_SEL	TXD	RXD	TXO	Remarks
1	0	X	0	Shut down	Shut down	
	0	1	0	RXA	X	Latch TXD *1
	0	1	1	RXB	X	Latch TXD *1
0	0	0	X	RXA	HPW	TXO output High Power mode
0	1	0	X	↓	MPW	TXO output Middle Power mode
1	1	0	X	↓	LPW	TXO output Low Power mode
0	0	1	X	RXB	HPW	TXO output High Power mode
0	1	1	X	↓	MPW	TXO output Middle Power mode
1	1	1	X	↓	LPW	TXO output Low Power mode

*1 F_SEL → 0 ; reset latching state of TXD, and turn to RXA channel.

*2 RXA : RXA channel mode ; 115kbps or less (SIR 115.2kbps, 9600bps)

*3 RXB : RXB channel mode ; 115kbps or more (FIR 1.152Mbps, 4Mbps)

13) Block diagram

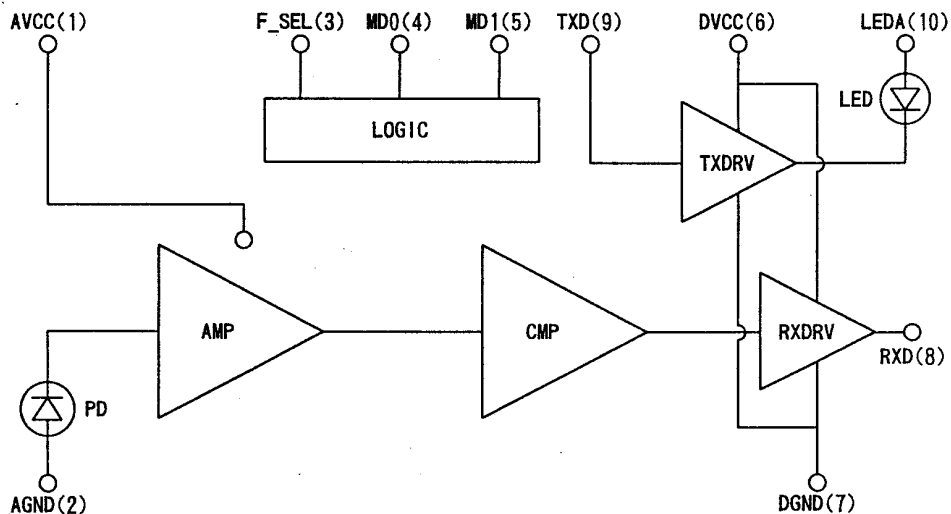

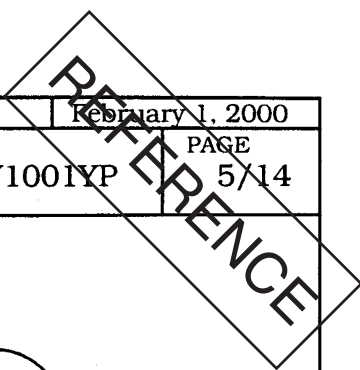

14) Recommended Foot pattern of PCB

(1) Dimension in parenthesis are shown for reference.

(2) Unit : mm

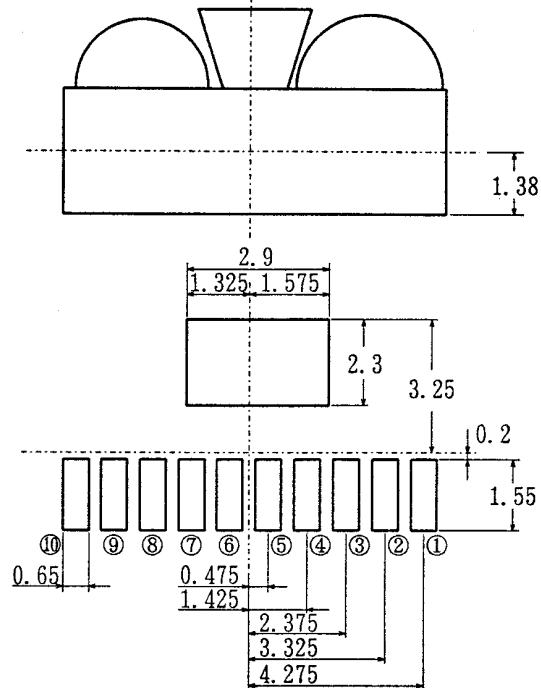

Pin	Pin name	Symbol	Pin	Pin name	Symbol
①	Analog VCC	AVCC	⑥	Digital VCC	DVCC
②	Analog Ground	AGND	⑦	Digital Ground	DGND
③	Channel Select	F_SEL	⑧	Receiver signal output	RXD
④	Mode Select 0	MDO	⑨	Transmitter signal input	TXD
⑤	Mode Select 1	MD1	⑩	LED Anode	LEDA

※ Connect foot pattern of shield case to GND pattern.

15) Recommendable size of solder creamed paste (Reference)

Please open the solder mask as below so that the size of solder creamed paste for this device before reflow soldering must be as large as one of the foot pattern land indicated at 14).

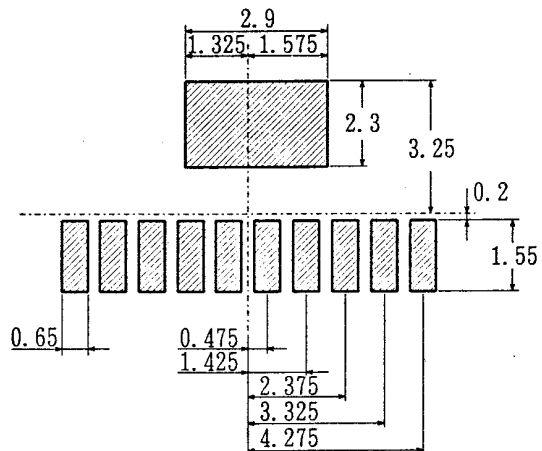

: Soldering paste area

※ Dimension in parenthesis are shown for reference.

Unit : mm

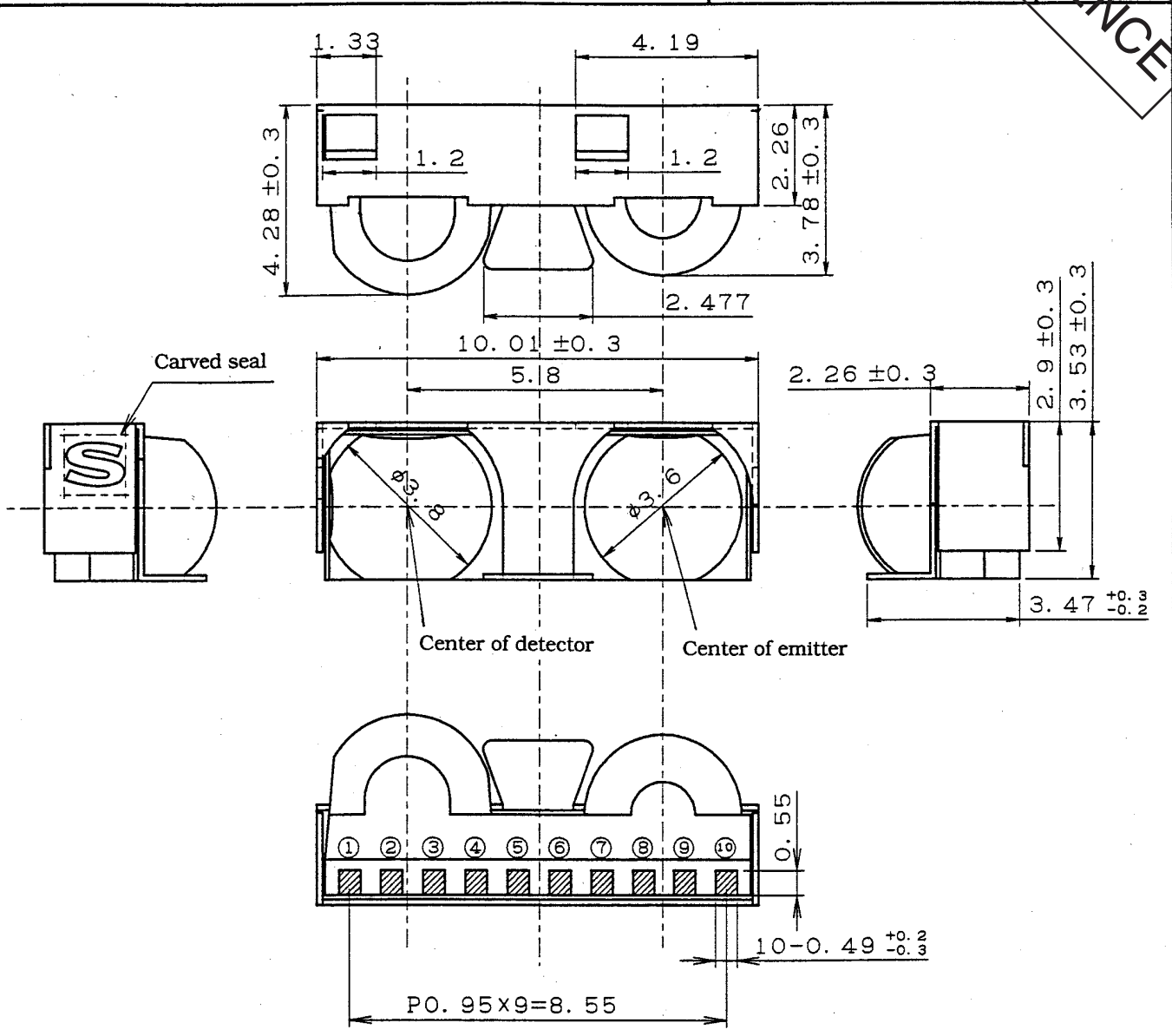
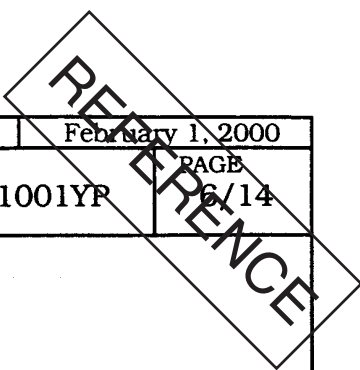

Pin	Pin name	Symbol
①	Analog VCC	AVCC
②	Analog Ground	AGND
③	Channel Select	F_SEL
④	Mode Select 0	MD0
⑤	Mode Select 1	MD1
⑥	Digital VCC	DVCC
⑦	Digital Ground	DGND
⑧	Receiver signal Output	RXD
⑨	Transmitter signal Input	TXD
⑩	LED Anode	LEDA

- 1) area : Au plating
- 2) Unspecified tolerance shall be ±0.2.

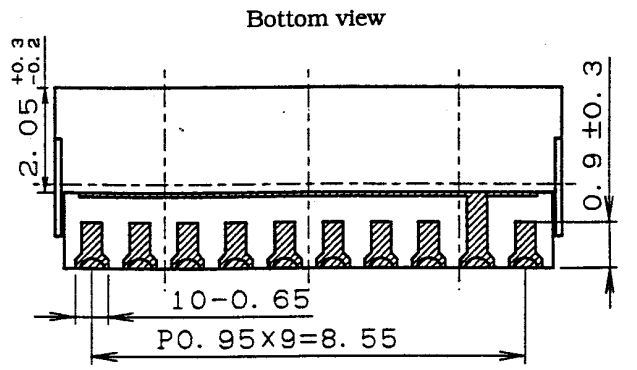

Scale	Unit
1/1	7/1
Name	GP2W1001YP Outline Dimensions

REFERENCE

3. Ratings and characteristics

3.1 Absolute maximum ratings

Parameter	Symbol	Ratings	Unit
Supply voltage	VCC, RXVCC	6.0	V
Transmission signal duty ratio	TXduty	50	%
Operating temperature	Topr	-10 to +70	°C
Storage temperature	Tstg	-20 to +85	°C

Note : Transmission signal duty ratio show the time share of H level of transmission wave at TX terminal. The frequency shall be 1kHz or more.

3.2 Recommended operating conditions

Parameter	Ratings	Unit
Operating supply power voltage	2.7 to 5.5	V
Operating temperature range	0 to +70	°C
SIR bit rate	9.6 to 115.2	kbps
FIR bit rate	1.152/4	Mbps
ASK bit rate	9.6 to 57.6	kbps

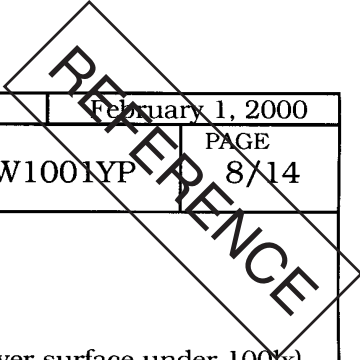

3.3 Electrical characteristics

(Ta=25±3°C, Vcc=3.3V±0.1V, 5V±0.1V, ambient light on receiver surface under 100lx)

Parameter	Symbol	MIN.	TYP.	MAX.	Unit	Remark	
Current consumption at no input signal	Icc	-	-	1.2	mA	RXOUT : H, TXIN : L, VCC=3.3V	
		-	-	1.5		RXOUT : H, TXIN : L, VCC=5.0V	
Current consumption at Shut-down mode	Iccs	-	0.1	1	μA	RXOUT : H, TXIN : L, VCC=3.3V	
		-	0.2	2		RXOUT : H, TXIN : L, VCC=5.0V	
LED peak current	Iccp	-	400	600	mA	Peak value, VCC=3.3V (Rext=2.4Ω) VCC=5V (Rext=6.8Ω)	
Switching time (Shut down to standby)	t _{RSD}	-	-	1.5	ms	-	
Receive sensitivity (φ ≤ 15°)	Srx _φ	0.04	-	5000	W/m ²	SIR : 9.6k to 115.2kbps	※ 3.4 3.5
		0.10	-	5000		ASK : 9.6k to 19.2kbps, FIR : 1.152M/Mbps	
RXOUT terminal "L" level	VOL	-	-	0.4	V	VCC=3.3, 5.0V	
RXOUT terminal "H" level	VOH	Vcc-0.4	-	-	V	VCC=3.3, 5.0V	
RXOUT Rise time	trrx	-	-	40	ns		
RXOUT Fall time	tfrx	-	-	40	ns		
RXOUT latency	tlrx	-	-	0.5	ms		
Peak emission wavelength	λ _{rx}	-	940	-	nm		

REFERENCE

3.3 Electrical characteristics

(Ta=25±3°C, Vcc=3.3V±0.1V, 5V±0.1V, ambient light on receiver surface under 100lx)

Parameter	Symbol	MIN.	TYP.	MAX.	Unit	Remark
RXOUT terminal pulse width	tw1	0.2	-	1.6	μs	ASK mode, 19.2kbps
	tw2	1.0	-	22	μs	SIR mode, 9.6kbps
	tw3	1.0	-	3	μs	SIR mode, 115.2kbps
	tw4	110	-	500	ns	FIR mode, 1.152Mbps
	tw5	85	-	165	ns	FIR mode, 4Mbps (Single)
	tw6	210	-	290	ns	FIR mode, 4Mbps (Double)
Radiant intensity (Full Power)	$I_{EF\phi}$	100	-	500	mW/sr	$\phi \leq 15^\circ$
TXIN terminal "L" level	VIL	-	-	Vcc*0.2	V	VCC=3.3, 5.0V
TXIN terminal "H" level	VIH	Vcc*0.8	-	-	V	VCC=3.3, 5.0V
TXIN terminal input current	IIL	-0.1	0	0.1	μA	TXIN=Vcc=GND
	IIH	-	-	50	μA	TXIN=Vcc=5.0V
Output Radiant rise time	trtx	-	-	40	ns	
Output Radiant fall time	tftx	-	-	40	ns	

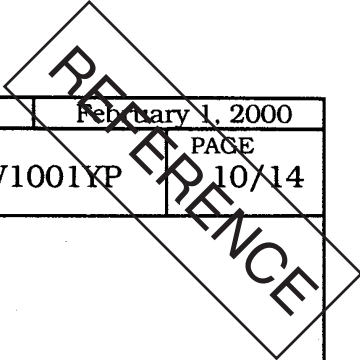

3.4 Output waveform specification (Detector side) ($C_L \leq 10pF$)

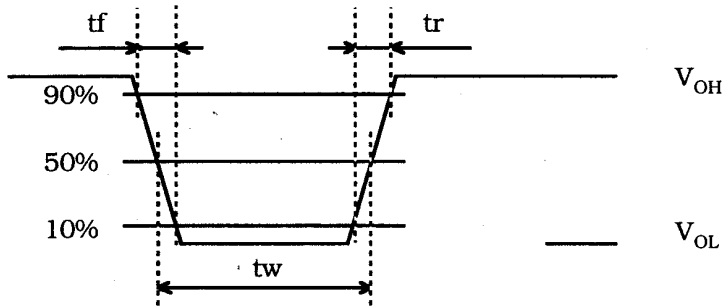

3.5 Standard optical system (Detector side)

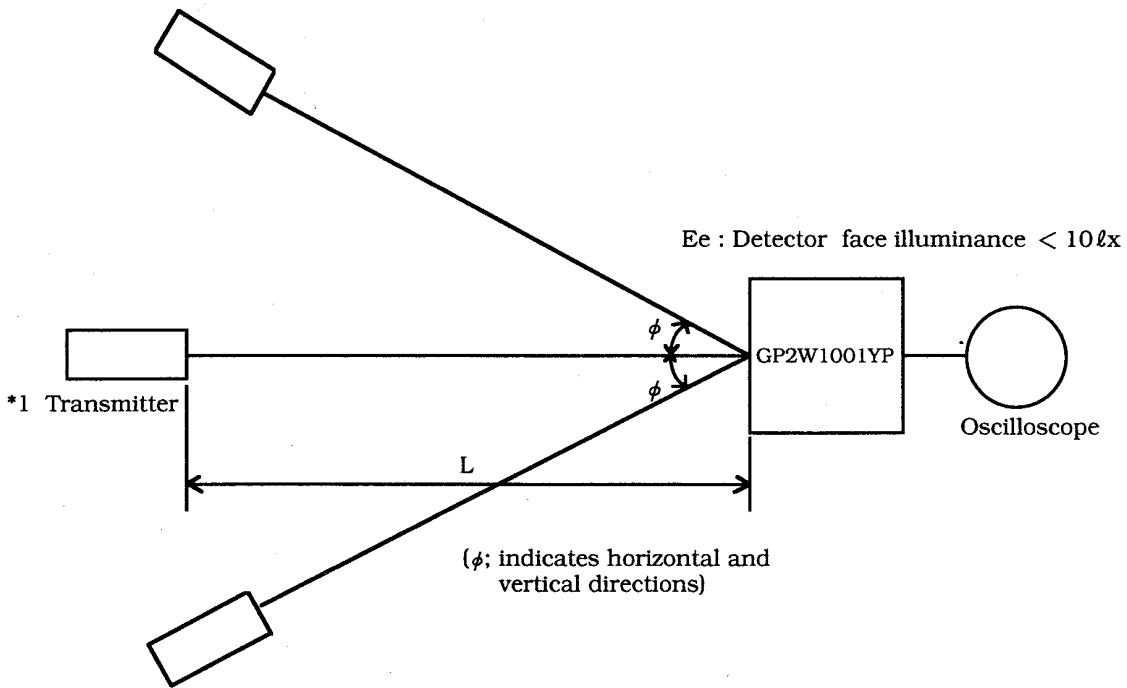

*1 When emitting diode GL710 ($\lambda p=850$ to $900nm$) as transmitter output continuation signal following above condition, output signal (*3.4) on optical system shall be completed detector side electrical characteristics in item 3.3.

Data rate	T_1	T_2	T_2/T_1	Radiant intensity
9.6kbps	$104 \mu s$	$19.53 \mu s$	3/16	40mW/sr
115.2kbps	$8.68 \mu s$	$1.63 \mu s$	3/16	40mW/sr
1.152Mbps	868ns	217ns	1/4	100mW/sr
4Mbps	500ns	125ns	1/4	100mW/sr
ASK	$2 \mu s$	$1 \mu s$	1/2	100mW/sr

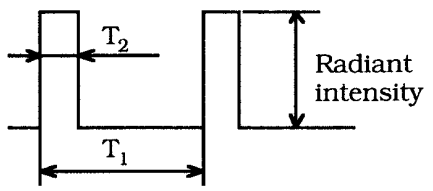

REFERENCE

3.6 Output waveform specification (Emitter side)

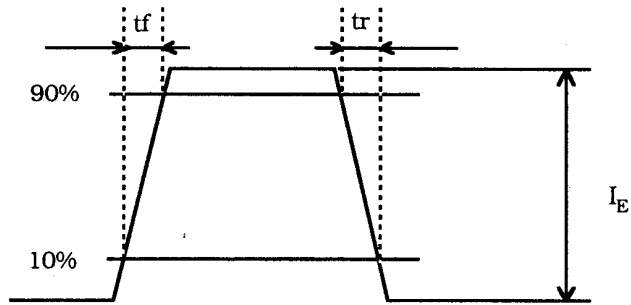

3.7 Standard optical system (Emitter side)

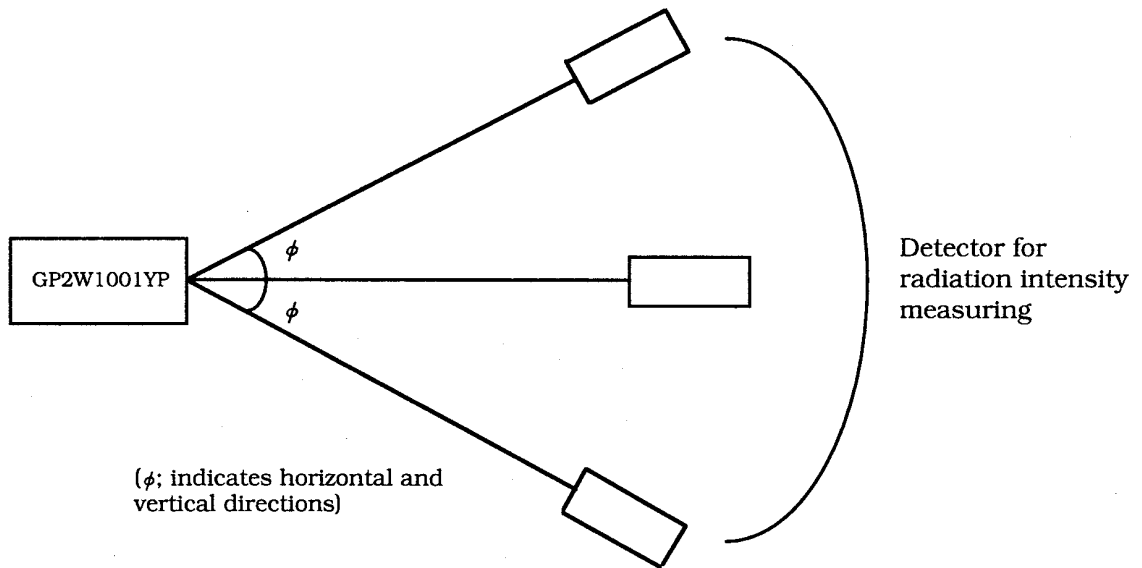

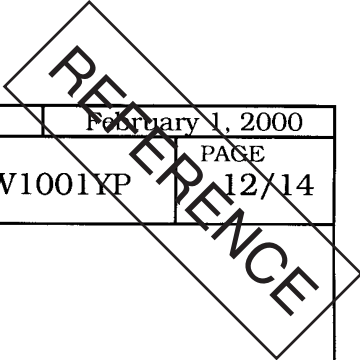

3.8 Recommended circuit (Emitter side)

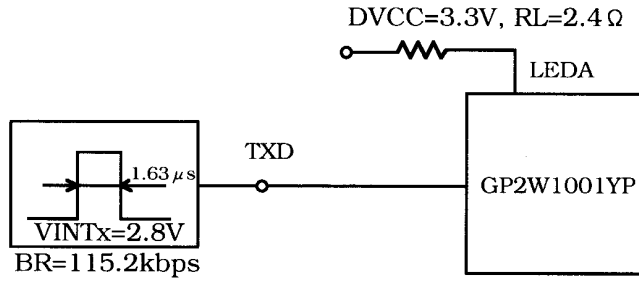

3.9 Peak forward current vs. ambient temperature

Pulse width $\leq 22 \mu\text{s}$, Duty ratio 1/4

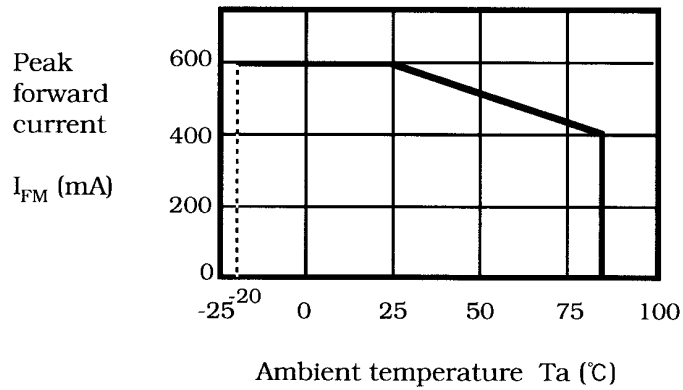

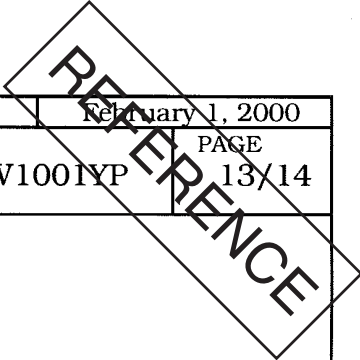

4. Reliability

The reliability of products shall satisfy items listed below.

Confidence level : 90%
LTPD : 10%/20%

Test Items	Test Conditions	Failure Judgement Criteria	Samples (n) Defective(C)
* Temperature cycling	1 cycle -20°C to +85°C (30min) (30min) 20 cycles test	$I_{cc} > Up \times 1.2$ $tw_{1\ to\ 6} > Up \times 1.2$	n=22, c=0
* High temp. and high humidity storage	+40°C, 90%RH, 240h	$tw_{1\ to\ 6} < Low \times 0.8$	n=22, c=0
* High temp. storage	+85°C, 240h	$I_{EF\ \phi} < Low \times 0.8$	n=22, c=0
* Low temp. storage	-20°C, 240h		n=22, c=0
* Operation life 1	+25°C, Vcc=5V, 240h		n=11, c=0
* Operation life 2	+25°C, $I_{FM}=600mA$, 240h Pulse width 22 μs, Duty ratio 1/4		n=11, c=0
Mechanical shock	1000m/s ² , 6ms 3 times/±X, ±Y, ±Z direction		n=11, c=0
Variable frequency vibration	200m/s ² 100 to 2000 to 100Hz /Approx. for 4min 48 min/X, Y, Z direction		Up: Upper specification limit
Reflow solder heat	240°C, 10s Regarding temperature profile, Refer to attached soldering notes.	Low: Lower specification limit	n=11, c=0

In the test *mark above, the sample to be tested shall be left at normal temperature and humidity for 2h after it is taken out of the chamber. (No dew point)

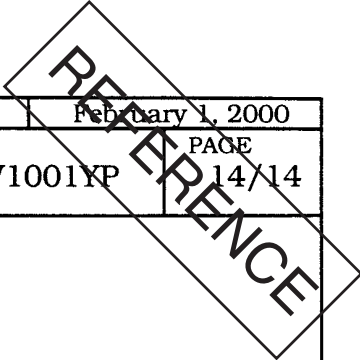

5. Outgoing inspection

(1) Inspection lot

Inspection shall be carried out per each delivery lot.

(2) Inspection method

A single sampling plan, normal inspection level II based on ISO 2859 shall be adopted.

Parameter		Inspection items and test method	AQL(%)	
Major defect	1	Disconnection, short	0.1	
	2	Inverse polarity on terminal		
	3	Soldering defect (Obstacle to use)		
	4	Electrical characteristic defect in parameter 3.3.		
Minor defect	1	Appearance defect	0.25	
		Parameter		Judgement criteria
		Split, Chip, Scratch, Stain, Blur		One which affects the characteristics of parameter 3.3 shall be defect.

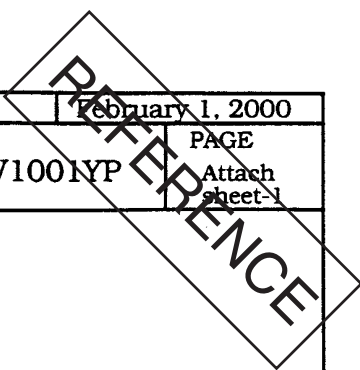

Precautions for Soldering

1. In case of solder reflow

Please carry out only one time soldering at the temperature and the time within the temperature profile as shown in the figure below.

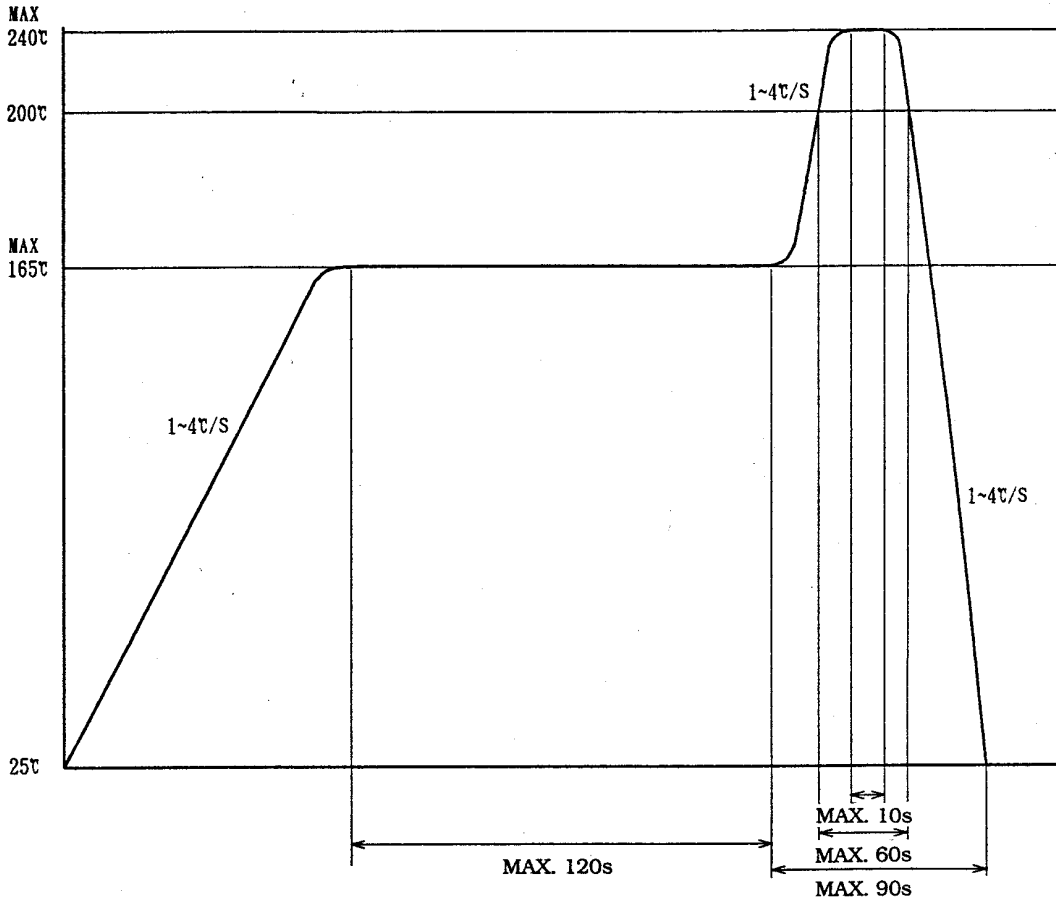

2. Other precautions

An infrared lamp used to heat up for soldering may cause a localized temperature rise in the resin. So keep the package temperature within that specified in Item 1. Also avoid immersing the resin part in the solder. Even if within the temperature profile above, there is the possibility that the gold wire in package is broken in case that the deformation of PCB gives the affection to lead pins. Please use after confirmation the conditions fully by actual solder reflow machine.

3. Soldering

- Soldering iron shall be less than 25W, and temperature of point of soldering iron shall use at less than 260°C.
- Soldering time shall be within 5s.
- Soldered product shall treat at normal temperature.
- Solder : 6/4 solder or included Ag solder.

REFERENCE

Taping specifications

1. Application

This packing specification sheets specify the taping specifications for GP2W1001YP.

2. Taping method

2-1. Tape structure and Dimensions (Refer to the attached sheets-2-2.)

The tape shall have a structure in which a cover tape is sealed heat-pressed on the carrier tape of conductive PET.

2-2. Reel structure and Dimensions (Refer to the attached sheets-2-3.)

The taping reel shall be conductive plastic with its dimensions as shown in the attached drawing.

2-3. Direction of product insertion (Refer to the attached sheets-2-3.)

Product direction in carrier tape shall be that electrode side of product places on the cover tape side and lens side of product places on the hold side of the tape.

2-4. The way to repair taped failure devices

The way to repair taped failure devices cut a bottom of carrier tape with a cutter, and after replacing to good devices, the cutting portion shall be sealed with adhesive tape.

3. Adhesiveness of cover tape

The exfoliation force between carrier tape and cover tape shall be 0.2N to 1N for the angle from 160° to 180° .

4. Rolling method and quantity

Wind the tape back on the reel so that the cover tape will be outside the tape. Attach more than 20cm of blank tape to the trailer and the leader of the tape and fix the both ends with adhesive tape. One reel shall contain 2000pcs.

5. Safety protection during shipping

There shall be no deformation of component or degradation of electrical characteristics due to shipping.

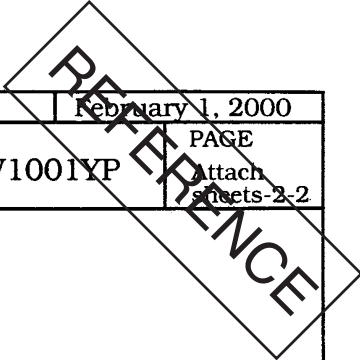

2-1. Tape structure and Dimensions

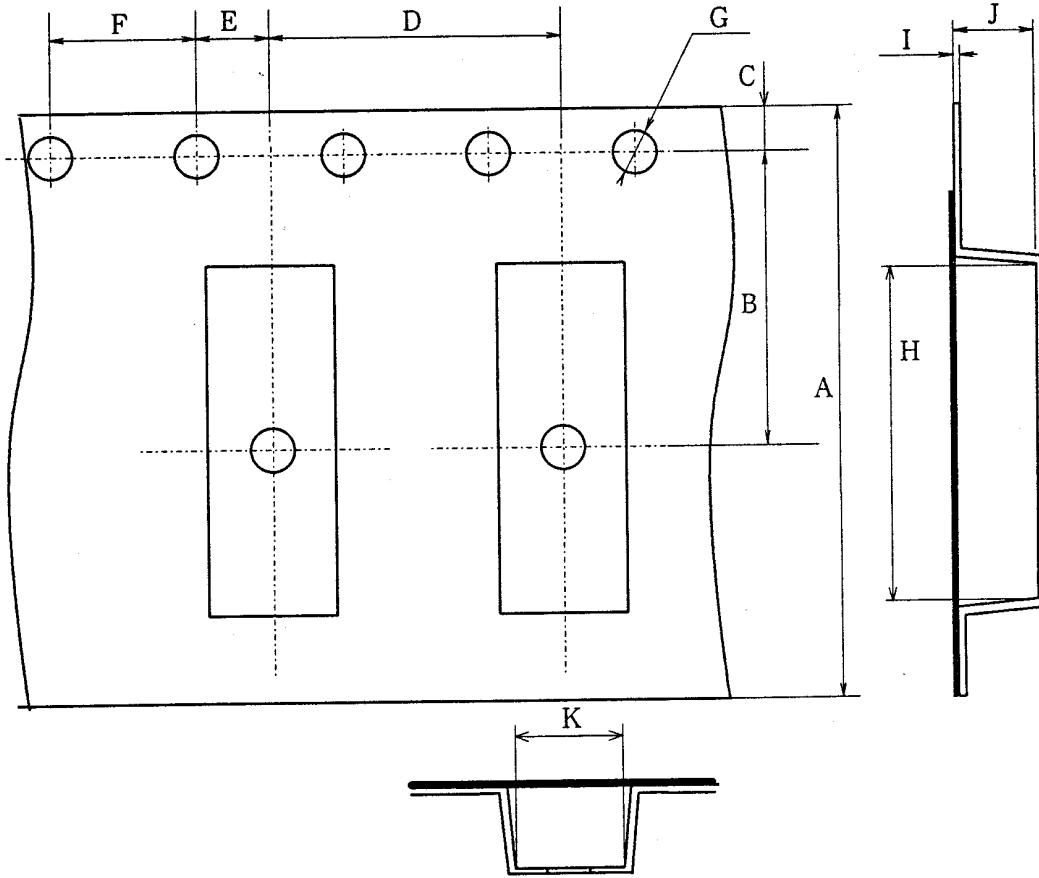

Symbol	A	B	C	D	E	F
Unit						
mm	±0.3 16.0	±0.1 7.5	±0.1 1.75	±0.1 8.0	±0.1 2.0	±0.1 4.0

Symbol	G	H	I	J	K
Unit					
mm	+0.1 -0.0 φ 1.5	±0.1 10.6	±0.05 0.3	±0.1 4.00	±0.1 4.80

REFERENCE

2-2. Reel structure and Dimensions

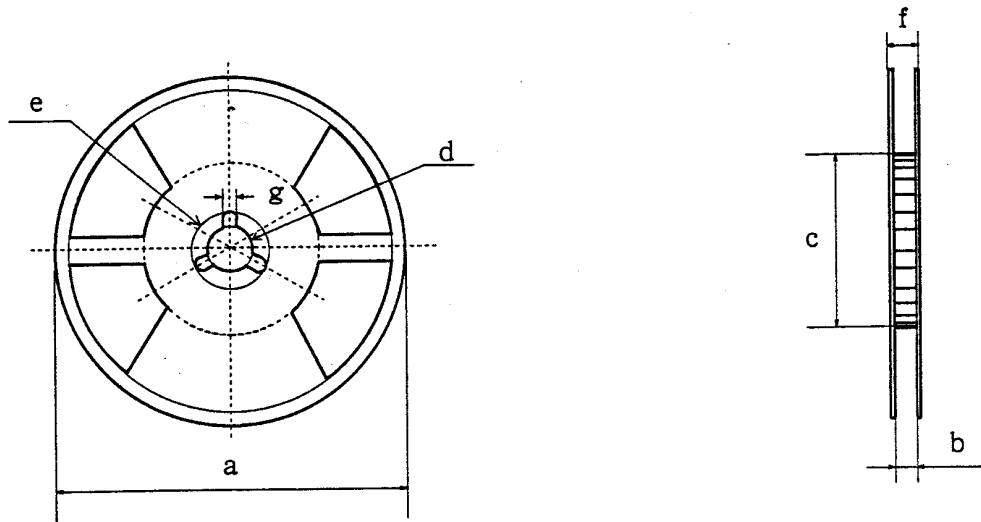

Symbol Unit	Check word						
	a	b	c	d	e	f	g
mm	330±2	17.5±0.5	100±0.1	13±0.2	21±0.8	22.4 MAX	2±0.5

2-3. Direction of product insertion

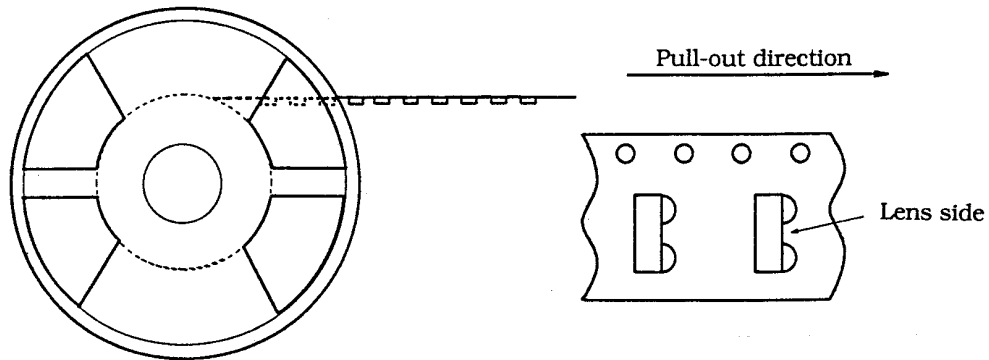

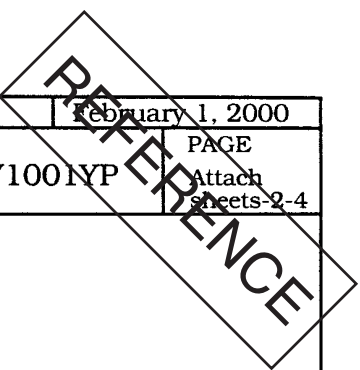

Taping moisture-proof packing

1. Application

This packing specification sheets apply to the moist-proof packing for the GP2W1001YP in the taping package.

2. Packaging specifications

2.1 Packaging material

Name	Material	Q'ty
Aluminum laminate bag	Aluminum polyethylene	Refer to 2.2
Label	Paper(-made)	-
Siccative	-	-
Outer case	Paper(-made)	-
Pads	Paper(-made)	-

2.2 Packaging method

- (1) Seal the aluminum laminated bag that contains tape reel (contains 2,000 devices per reel) and siccative.
- (2) Fill necessary information to the label and paste it on the aluminum laminate bag.
- (3) Pack 4 aluminum laminated bags (contains 1 reel each) into the designated outer case, where paper pads are placed on the bottom and top of the outer case, as well as each layer of the aluminum laminated bags.

Package shape	Product	Q'ty	Moisture-proof sack Q'ty
Tape reel (φ 330mm)	1 model	2000pcs./reel	1reel/laminated bag

Minimum order/shipment q'ty should be 1 laminated bag.

- (4) The outer case would be then sealed with the craft tape, with indication of model name, quantity, and outgoing inspection date on the case.
(total of 8,000pcs. per carton)

ED-00013	February 1, 2000
MODEL No. GP2W1001YP	PAGE Attach sheets-2,5

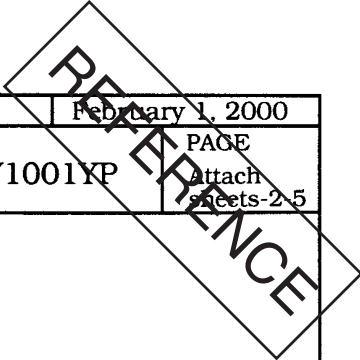

3. Storage and Treatment after Unsealed

3.1 Storage conditions

The delivered product should be stored with the conditions shown below;

Storage temperature : 10 to 30°C

Humidity : below 60%RH

3.2 Treatment after open

- (1) After unsealed, devices should be mounted under the temperature condition of 10 to 30°C, at the humidity condition of below 60%RH, within 2 days.
- (2) In case that long term storage is needed, devices should either be stored in dry box, or re-sealed to moist-proof bag with siccative and leave them in the environment where the temperature is 10 to 30°C, at the humidity condition of below 60%RH. Devices must be mounted within 2 weeks.

3.3 Baking before mounting

In the event that the devices are not maintained in the storage conditions described above, or the enclosed siccative indicator already turned its color to pink, baking must be applied before devices are to be mounted: Please also note that baking should only be applied once.

Recommended condition : 100°C, 12 to 24 hours

- ※ Baking will not properly done in packing condition. To complete the baking properly, devices should either be temporary mounted to PCB with adhesive, or placed to the metal tray.

(The temporary mounting shall not be done by soldering, but by adhesive etc.)

REFERENCE

<Fig.1>

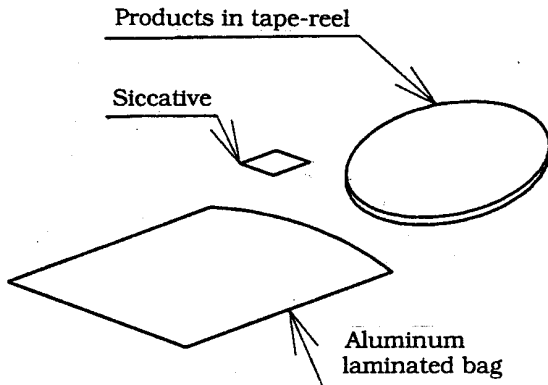

<Fig.3>

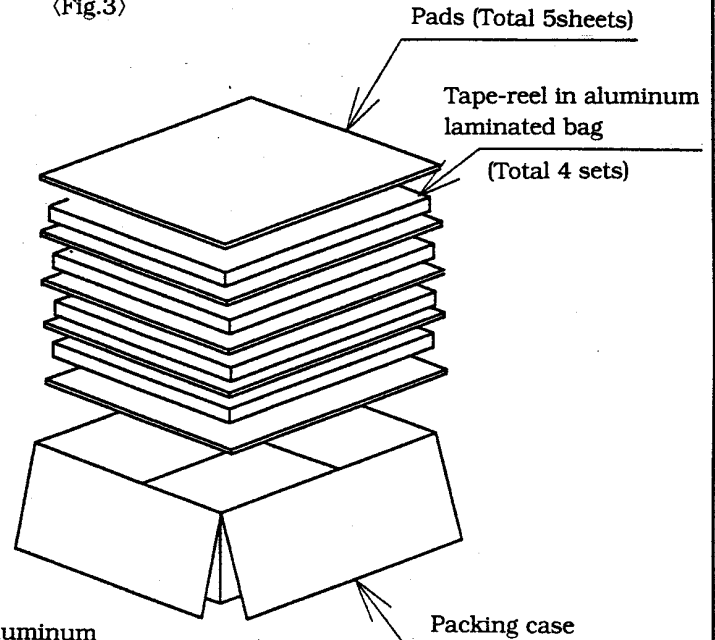

<Fig.2>

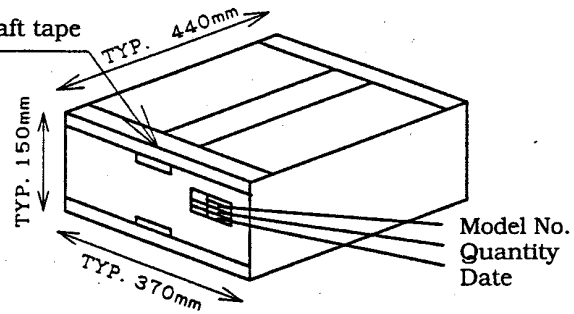
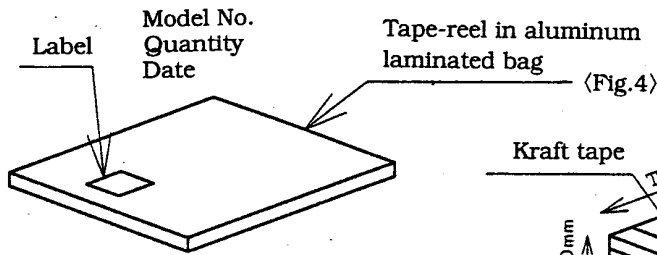

Package method

- (1) Seal the aluminum laminated bag included the tape reel with 2000pcs. and siccative. <Fig.1>
- (2) Fill up the model name, quantity etc. in the blank of label and paste on the bag. <Fig.2>
- (3) Put the four moisture-proof laminated bag in the ruled case. Put the pad between the bags, and top and bottom. <Fig.3>
- (4) The case seals with kraft tape, and indicate model name and quantity. <Fig.4>
(8000pcs./package)

Total packaged mass : Approx 3.3kg

Name	GP2W1001YP Packing specification
------	-------------------------------------

IrDA Data, 4Mbps Transceivers, GP2W1001YP