

MITSUBISHI GENERAL USE THYRISTORS

# FT1500AU-240

HIGH VOLTAGE, HIGH POWER, GENERAL USE  
DYNAMIC GATE, PRESS PACK TYPE

## FT1500AU-240



- $I_T(AV)$  Average on-state current ..... 1500A
- $V_{DRM}$  Repetitive peak off state voltage ..... 12000V
- Press pack type

## OUTLINE DRAWING

Dimension in mm

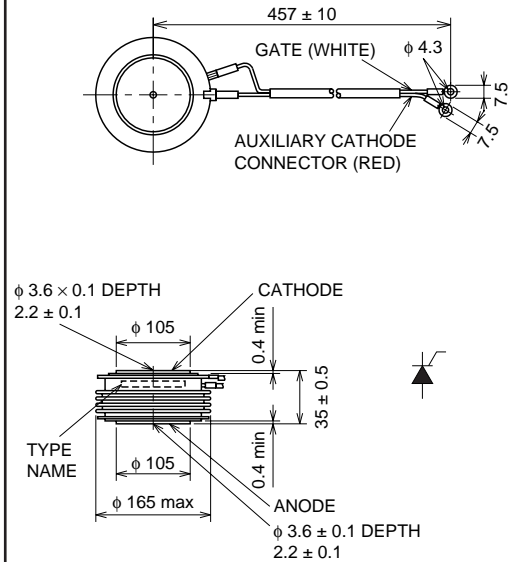

## APPLICATION

AC switch for high voltage line, SVC

## ABSOLUTE MAXIMUM RATINGS

Symbol	Parameter	Voltage class		Unit
		240		
VRRM	Repetitive peak reverse voltage	12000		V
VRSM	Non-repetitive peak reverse voltage	12000		V
VR(DC)	DC reverse voltage	9600		V
VDRM	Repetitive peak off-state voltage	12000		V
VDSM	Non-repetitive peak off-state voltage	12000		V
VD(DC)	DC off-state voltage	9600		V

Symbol	Parameter	Conditions	Ratings	Unit
$I_T(RMS)$	RMS on-state current		2360	A
$I_T(AV)$	Average on-state current	$f = 60\text{Hz}$ , sine wave $\theta = 180^\circ$ , $T_f = 88^\circ\text{C}$	1500	A
$I_{TSM1}$	Surge on-state current	One half cycle at 60Hz	34	kA
$I_{TSM2}$	Surge on-state current 2	One half cycle ( $t_w = 12\text{ms}$ ), $T_j = 125^\circ\text{C}$ start $V_{FP} = 6\text{kV}$ , $V_{RP} = 6\text{kV}$	28	kA
$I^2t$	Current-squared, time integration	One cycle at 60Hz	$4.8 \times 10^6$	$\text{A}^2\text{s}$
$di/dt$	Critical rate of rise of on-state current	$V_D = 1/2V_{DRM}$ , $I_G = 2.0\text{A}$ , $di_G/dt = 1.5\text{A}/\mu\text{s}$ , $T_j = 125^\circ\text{C}$	100	$\text{A}/\mu\text{s}$
PFGM	Peak forward gate power dissipation		30	W
PFG(AV)	Average forward gate power dissipation		8.0	W
VFGM	Peak forward gate voltage		20	V
VRGM	Peak reverse gate voltage		10	V
IFGM	Peak forward gate current		6.0	A
$T_j$	Junction temperature		$-40 \sim +125$	$^\circ\text{C}$
$T_{stg}$	Storage temperature		$-40 \sim +150$	$^\circ\text{C}$
—	Mounting force required	Recommended value 118	108 ~ 132	kN
—	Weight	Standard value	4000	g

# FT1500AU-240

HIGH VOLTAGE, HIGH POWER, GENERAL USE  
DYNAMIC GATE, PRESS PACK TYPE

## ELECTRICAL CHARACTERISTICS

Symbol	Parameter	Test conditions	Limits			Unit
			Min	Typ	Max	
I <sub>RRM</sub>	Repetitive peak reverse current	T <sub>j</sub> = 125°C, V <sub>RRM</sub> Applied	—	—	1200	mA
I <sub>DRM</sub>	Repetitive peak off-state current	T <sub>j</sub> = 125°C, V <sub>DRM</sub> Applied	—	—	1200	mA
V <sub>TM</sub>	On-state voltage	T <sub>j</sub> = 125°C, I <sub>TM</sub> = 3000A, Instantaneous measurement	—	—	4.0	V
dv/dt	Critical rate of rise of off-state voltage	T <sub>j</sub> = 125°C, V <sub>D</sub> = 1/2V <sub>DRM</sub>	2000	—	—	V/μs
V <sub>GT</sub>	Gate trigger voltage	T <sub>j</sub> = 25°C, V <sub>D</sub> = 6V, R <sub>L</sub> = 2Ω	—	—	2.5	V
V <sub>GD</sub>	Gate non-trigger voltage	T <sub>j</sub> = 125°C, V <sub>D</sub> = 1/2V <sub>DRM</sub>	0.2	—	—	V
I <sub>GT</sub>	Gate trigger current	T <sub>j</sub> = 25°C, V <sub>D</sub> = 6V, R <sub>L</sub> = 2Ω	—	—	350	mA
R <sub>th(j-f)</sub>	Thermal resistance	Junction to fin	—	—	0.005	°C/W

## PERFORMANCE CURVES

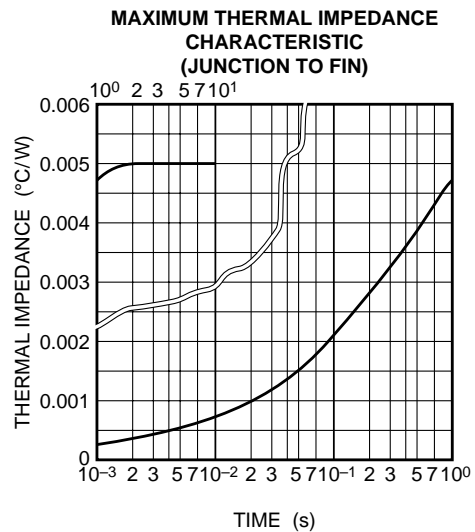
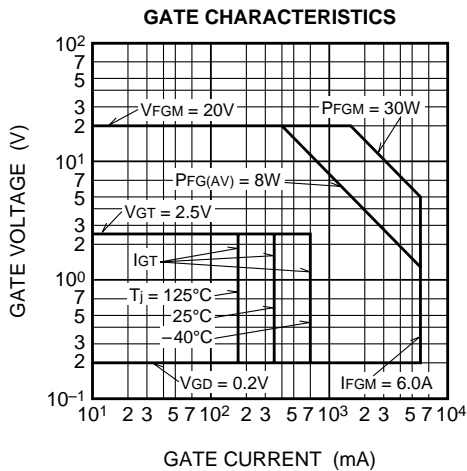
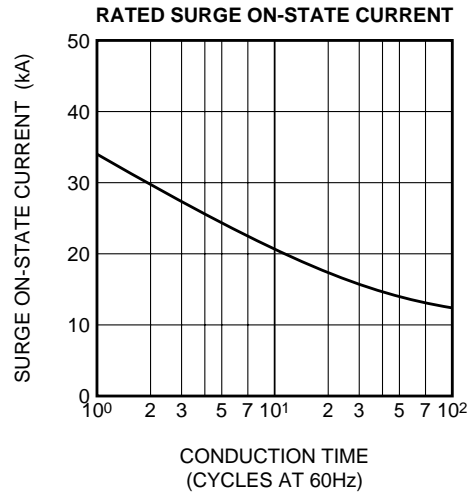
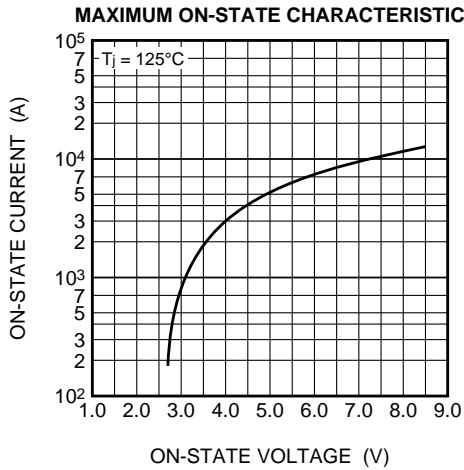

**FT1500AU-240**

HIGH VOLTAGE, HIGH POWER, GENERAL USE  
DYNAMIC GATE, PRESS PACK TYPE

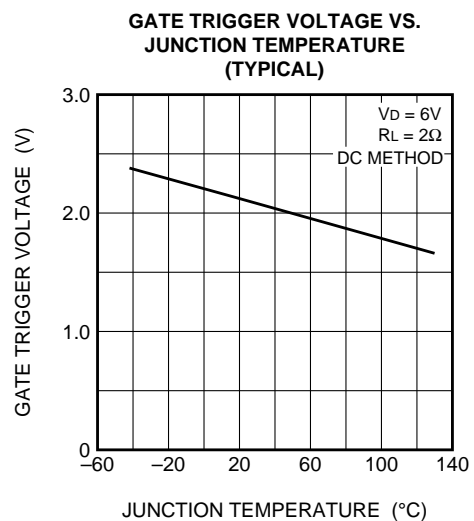
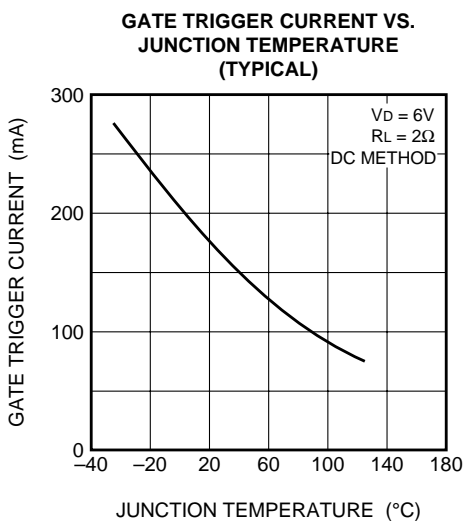
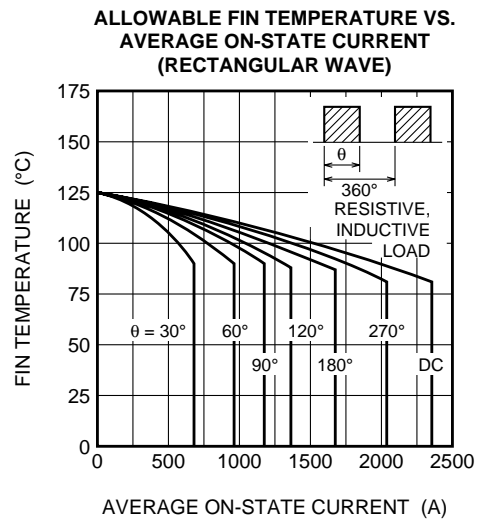
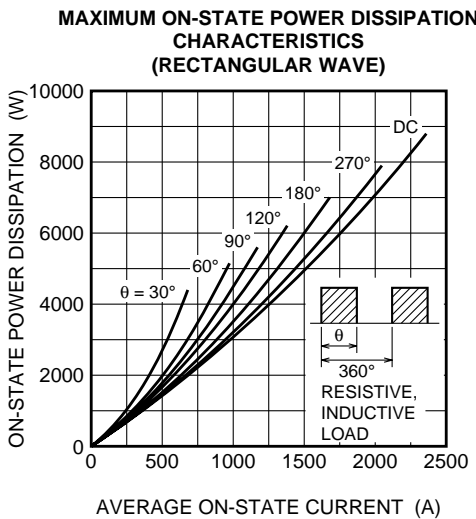
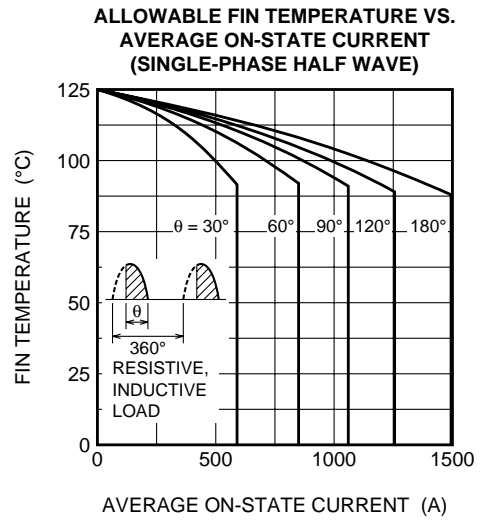
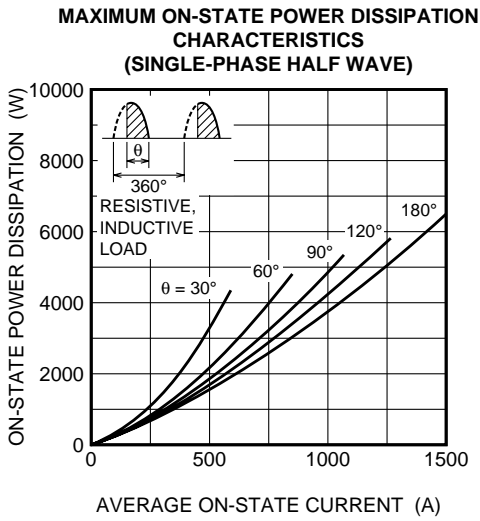

# FT1500AU-240

HIGH VOLTAGE, HIGH POWER, GENERAL USE  
DYNAMIC GATE, PRESS PACK TYPE

**HOLDING CURRENT LATCHING CURRENT VS. JUNCTION TEMPERATURE (TYPICAL)**

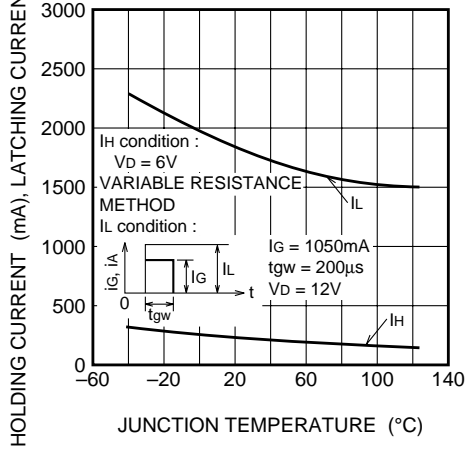

**TURN-ON TIME VS. GATE CURRENT (TYPICAL)**

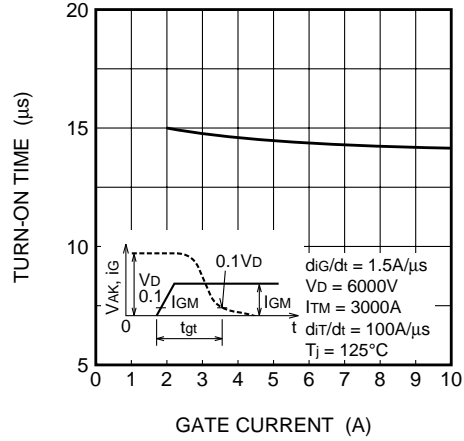

**TURN-OFF TIME VS. JUNCTION TEMPERATURE (TYPICAL)**

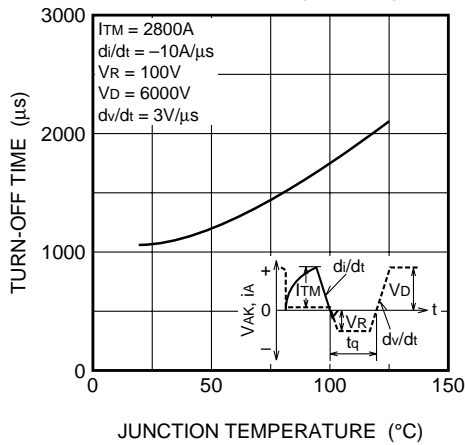

**TURN-OFF TIME VS. RATE OF RISE OF OFF-STATE VOLTAGE (TYPICAL)**

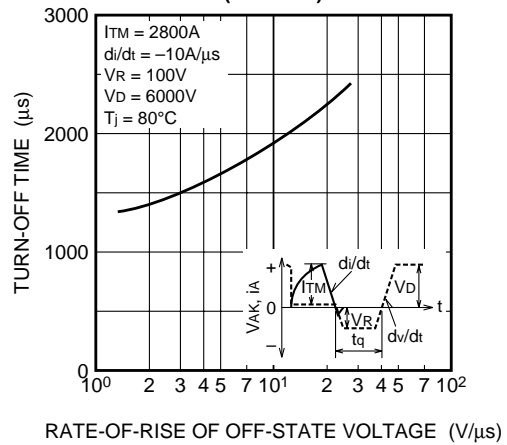

**REVERSE RECOVERED CHARGE VS. JUNCTION TEMPERATURE (TYPICAL)**

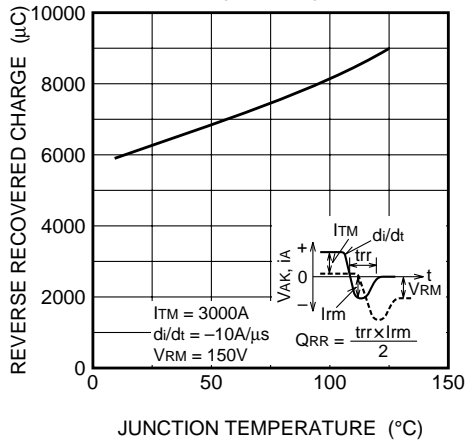

**REVERSE RECOVERED CHARGE VS. RATE OF DECREASE OF ON-STATE CURRENT (TYPICAL)**

