

MITSUBISHI Nch POWER MOSFET

# FS2VS-14A

HIGH-SPEED SWITCHING USE

## FS2VS-14A



- V<sub>DSS</sub> ..... 700V
- r<sub>DS (ON)</sub> (MAX) ..... 9.75Ω
- I<sub>D</sub> ..... 2A

## OUTLINE DRAWING

Dimensions in mm

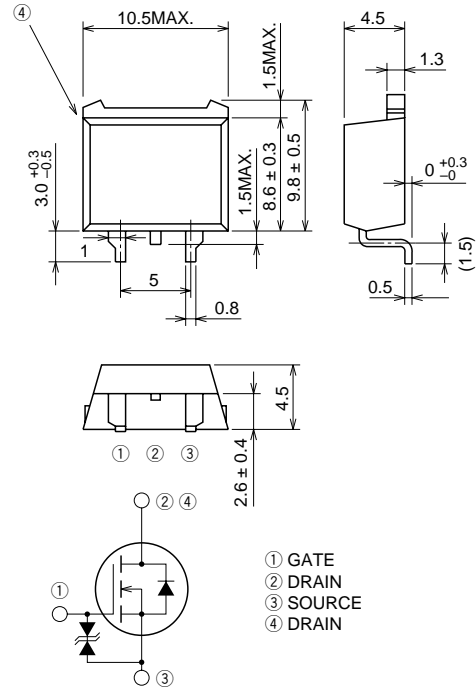

TO-220S

## APPLICATION

SMPS, DC-DC Converter, battery charger, power supply of printer, copier, HDD, FDD, TV, VCR, personal computer etc.

## MAXIMUM RATINGS (T<sub>c</sub> = 25°C)

Symbol	Parameter	Conditions	Ratings	Unit
V <sub>DSS</sub>	Drain-source voltage	V <sub>GS</sub> = 0V	700	V
V <sub>GSS</sub>	Gate-source voltage	V <sub>DS</sub> = 0V	±30	V
I <sub>D</sub>	Drain current		2	A
I <sub>DM</sub>	Drain current (Pulsed)		6	A
P <sub>D</sub>	Maximum power dissipation		65	W
T <sub>ch</sub>	Channel temperature		-55 ~ +150	°C
T <sub>stg</sub>	Storage temperature		-55 ~ +150	°C
—	Weight	Typical value	1.2	g

Feb.1999

**ELECTRICAL CHARACTERISTICS** (Tch = 25°C)

Symbol	Parameter	Test conditions	Limits			Unit
			Min.	Typ.	Max.	
V (BR) DSS	Drain-source breakdown voltage	Id = 1mA, VGS = 0V	700	—	—	V
V (BR) GSS	Gate-source breakdown voltage	IGS = ±100μA, VDS = 0V	±30	—	—	V
IGSS	Gate-source leakage current	VGS = ±25V, VDS = 0V	—	—	±10	μA
IdSS	Drain-source leakage current	VDS = 700V, VGS = 0V	—	—	1	mA
VGS (th)	Gate-source threshold voltage	Id = 1mA, VDS = 10V	2	3	4	V
rDS (ON)	Drain-source on-state resistance	Id = 1A, VGS = 10V	—	7.47	9.75	Ω
VDS (ON)	Drain-source on-state voltage	Id = 1A, VGS = 10V	—	7.47	9.75	V
yfs	Forward transfer admittance	Id = 1A, VDS = 10V	0.72	1.2	—	S
Ciss	Input capacitance	VDS = 25V, VGS = 0V, f = 1MHz	—	270	—	pF
Coss	Output capacitance		—	30	—	pF
Crss	Reverse transfer capacitance		—	5	—	pF
td (on)	Turn-on delay time	VDD = 200V, Id = 1A, VGS = 10V, RGEN = RGS = 50Ω	—	10	—	ns
tr	Rise time		—	12	—	ns
td (off)	Turn-off delay time		—	33	—	ns
tf	Fall time		—	21	—	ns
VSD	Source-drain voltage	IS = 1A, VGS = 0V	—	1.0	1.5	V
Rth (ch-c)	Thermal resistance	Channel to case	—	—	1.92	°C/W

**PERFORMANCE CURVES**

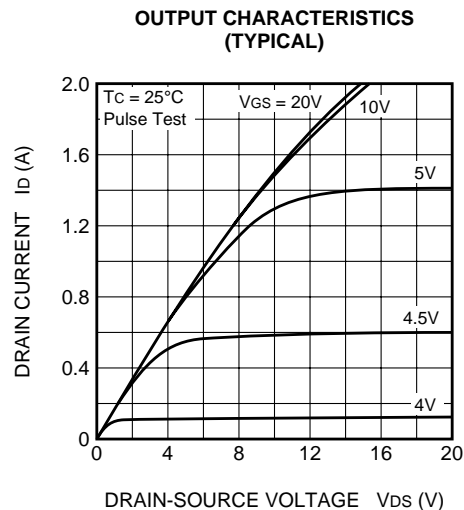
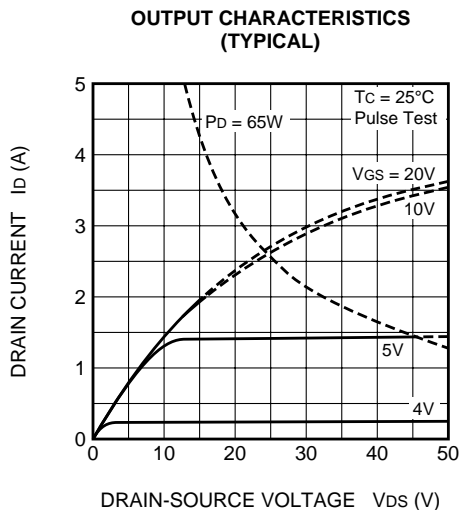
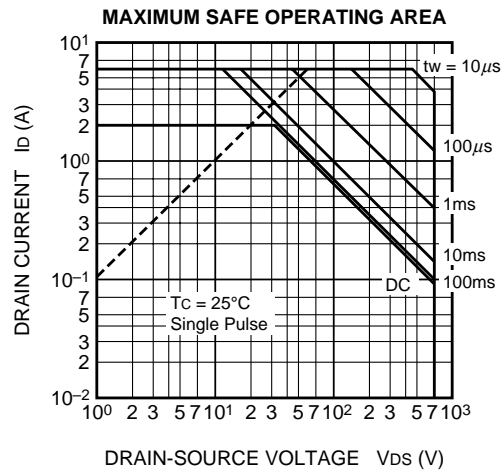
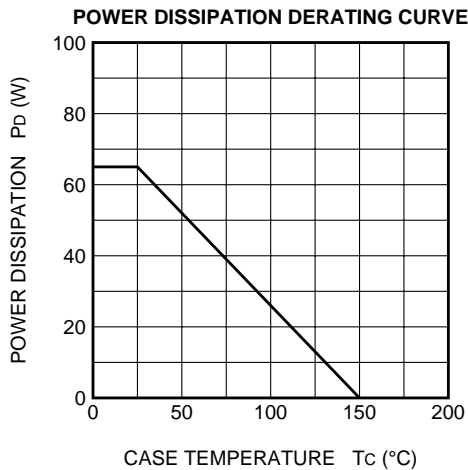

ON-STATE VOLTAGE VS. GATE-SOURCE VOLTAGE (TYPICAL)

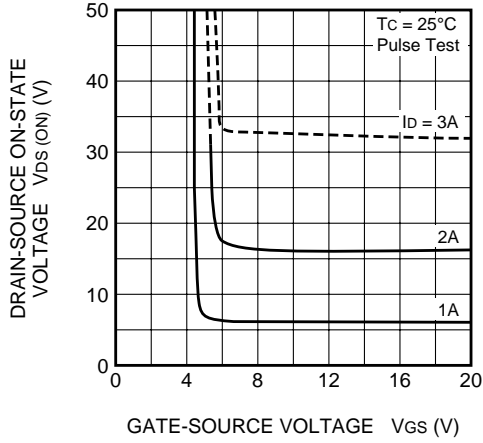

ON-STATE RESISTANCE VS. DRAIN CURRENT (TYPICAL)

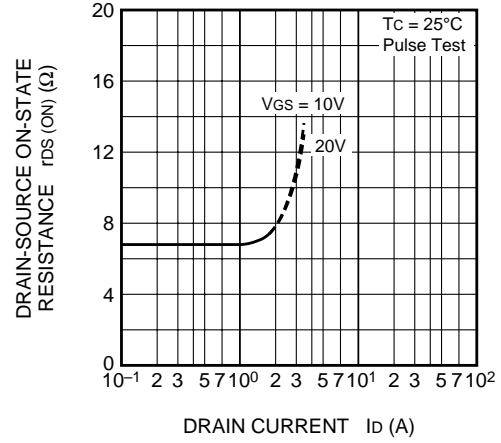

TRANSFER CHARACTERISTICS (TYPICAL)

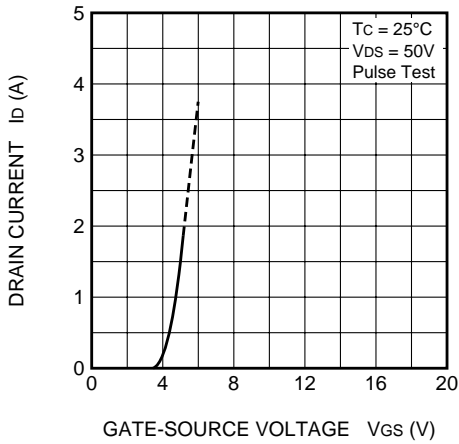

FORWARD TRANSFER ADMITTANCE VS. DRAIN CURRENT (TYPICAL)

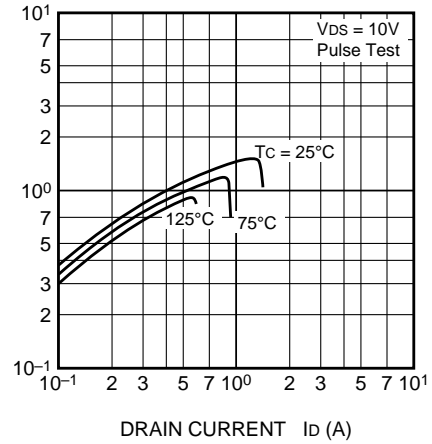

CAPACITANCE VS. DRAIN-SOURCE VOLTAGE (TYPICAL)

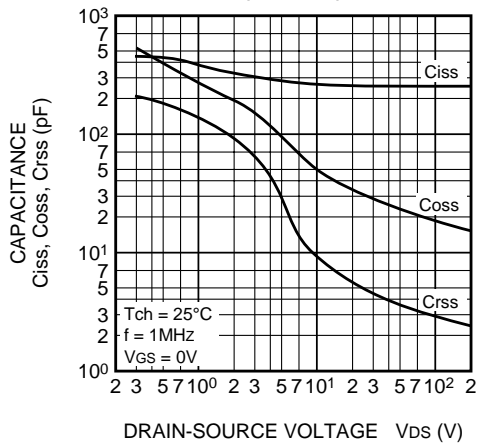

SWITCHING CHARACTERISTICS (TYPICAL)

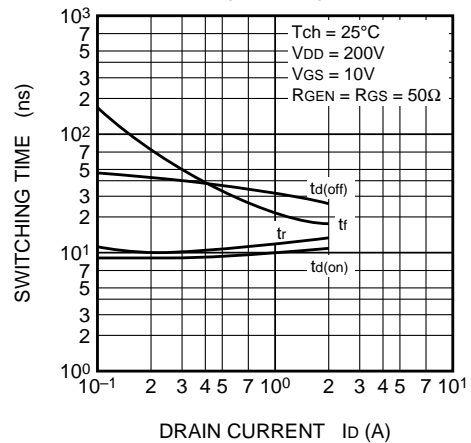

GATE-SOURCE VOLTAGE VS. GATE CHARGE (TYPICAL)

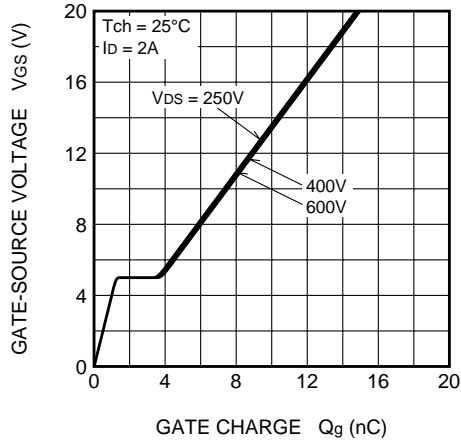

SOURCE-DRAIN DIODE FORWARD CHARACTERISTICS (TYPICAL)

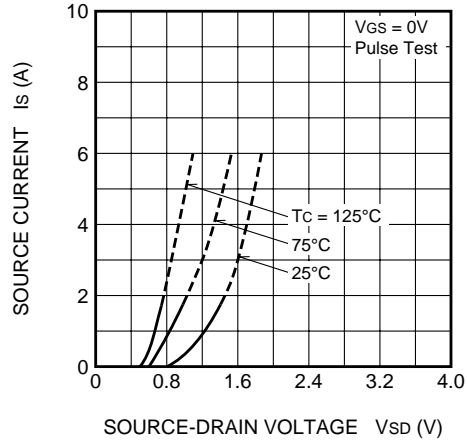

ON-STATE RESISTANCE VS. CHANNEL TEMPERATURE (TYPICAL)

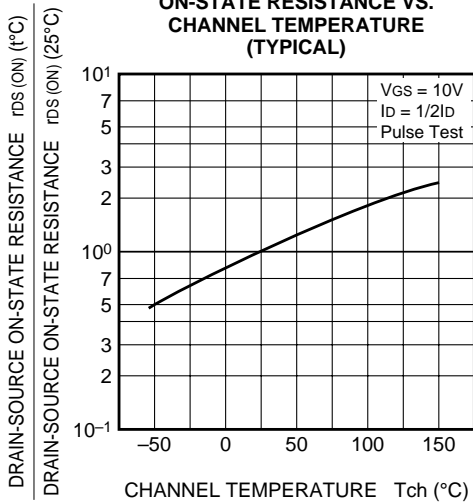

THRESHOLD VOLTAGE VS. CHANNEL TEMPERATURE (TYPICAL)

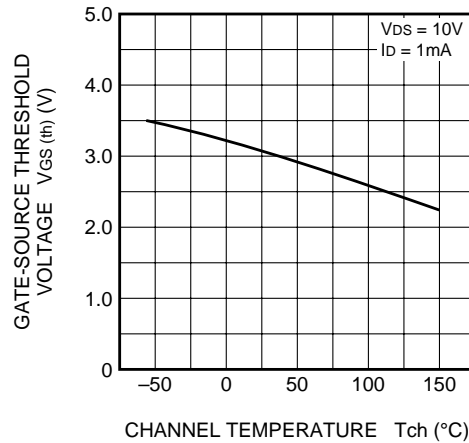

BREAKDOWN VOLTAGE VS. CHANNEL TEMPERATURE (TYPICAL)

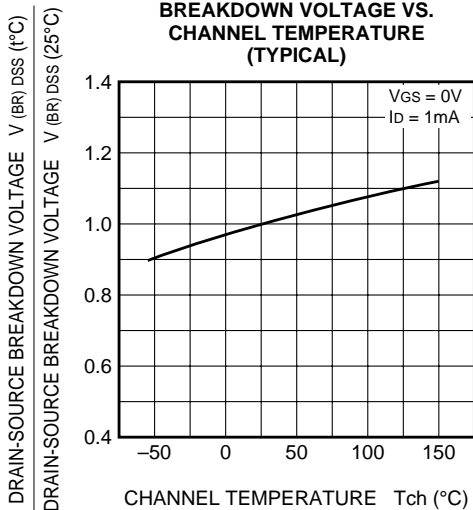

TRANSIENT THERMAL IMPEDANCE CHARACTERISTICS

