

# FK20VS-6

HIGH-SPEED SWITCHING USE

## FK20VS-6



- $V_{DSS}$  ..... 300V
- $r_{DS(ON)}$  (MAX) .....  $0.33\Omega$
- $I_D$  ..... 20A
- Integrated Fast Recovery Diode (MAX.) ..... 150ns

## OUTLINE DRAWING

Dimensions in mm

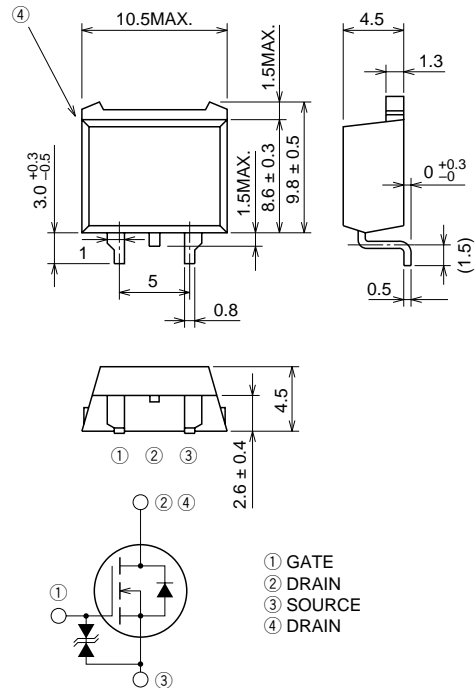

TO-220S

## APPLICATION

Servo motor drive, Robot, UPS, Inverter Fluorecent lamp, etc.

## MAXIMUM RATINGS (Tc = 25°C)

Symbol	Parameter	Conditions	Ratings	Unit
$V_{DSS}$	Drain-source voltage	$V_{GS} = 0V$	300	V
$V_{GSS}$	Gate-source voltage	$V_{DS} = 0V$	$\pm 30$	V
$I_D$	Drain current		20	A
$I_{DM}$	Drain current (Pulsed)		60	A
$I_S$	Source current		20	A
$I_{SM}$	Source current (Pulsed)		60	A
$P_D$	Maximum power dissipation		150	W
$T_{ch}$	Channel temperature		-55 ~ +150	°C
$T_{stg}$	Storage temperature		-55 ~ +150	°C
—	Weight	Typical value	1.2	g

**ELECTRICAL CHARACTERISTICS** (T<sub>ch</sub> = 25°C)

Symbol	Parameter	Test conditions	Limits			Unit
			Min.	Typ.	Max.	
V (BR) DSS	Drain-source breakdown voltage	I <sub>D</sub> = 1mA, V <sub>GS</sub> = 0V	300	—	—	V
V (BR) GSS	Gate-source breakdown voltage	I <sub>G</sub> = ±100μA, V <sub>DS</sub> = 0V	±30	—	—	V
I <sub>GSS</sub>	Gate-source leakage current	V <sub>GS</sub> = ±25V, V <sub>DS</sub> = 0V	—	—	±10	μA
I <sub>DSS</sub>	Drain-source leakage current	V <sub>DS</sub> = 300V, V <sub>GS</sub> = 0V	—	—	1	mA
V <sub>GS</sub> (th)	Gate-source threshold voltage	I <sub>D</sub> = 1mA, V <sub>DS</sub> = 10V	2	3	4	V
r <sub>DS</sub> (ON)	Drain-source on-state resistance	I <sub>D</sub> = 10A, V <sub>GS</sub> = 10V	—	0.25	0.33	Ω
V <sub>DS</sub> (ON)	Drain-source on-state voltage	I <sub>D</sub> = 10A, V <sub>GS</sub> = 10V	—	2.5	3.3	V
y <sub>fs</sub>	Forward transfer admittance	I <sub>D</sub> = 10A, V <sub>DS</sub> = 10V	8.5	13.0	—	S
C <sub>iss</sub>	Input capacitance	V <sub>DS</sub> = 25V, V <sub>GS</sub> = 0V, f = 1MHz	—	1400	—	pF
C <sub>oss</sub>	Output capacitance		—	280	—	pF
C <sub>rss</sub>	Reverse transfer capacitance		—	55	—	pF
t <sub>d</sub> (on)	Turn-on delay time		—	25	—	ns
t <sub>r</sub>	Rise time	V <sub>DD</sub> = 150V, I <sub>D</sub> = 10A, V <sub>GS</sub> = 10V, R <sub>GEN</sub> = R <sub>GS</sub> = 50Ω	—	50	—	ns
t <sub>d</sub> (off)	Turn-off delay time		—	150	—	ns
t <sub>f</sub>	Fall time		—	65	—	ns
V <sub>SD</sub>	Source-drain voltage		I <sub>S</sub> = 10A, V <sub>GS</sub> = 0V	—	1.5	2.0
R <sub>th</sub> (ch-c)	Thermal resistance	Channel to case	—	—	0.83	°C/W
t <sub>rr</sub>	Reverse recovery time	I <sub>S</sub> = 20A, di <sub>S</sub> /dt = -100A/μs	—	—	150	ns

**PERFORMANCE CURVES**

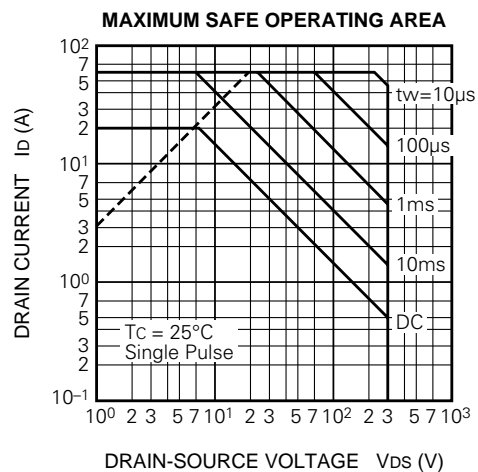
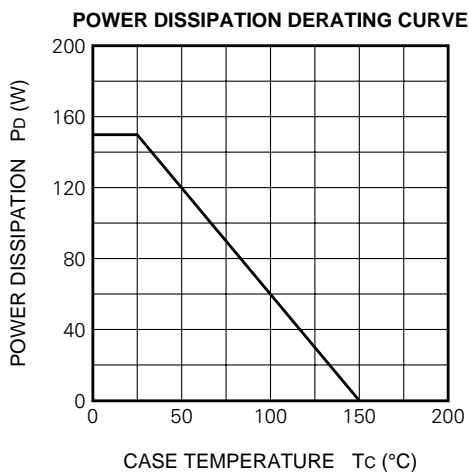

**OUTPUT CHARACTERISTICS (TYPICAL)**

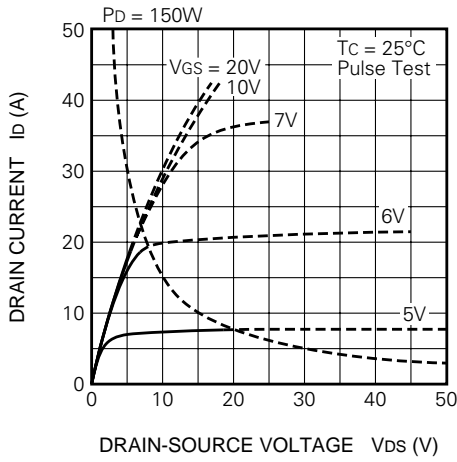

**OUTPUT CHARACTERISTICS (TYPICAL)**

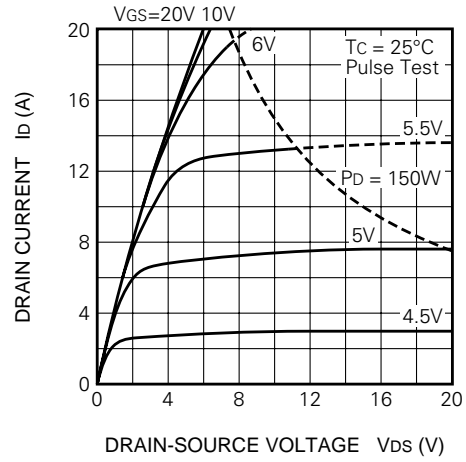

**ON-STATE VOLTAGE VS. GATE-SOURCE VOLTAGE (TYPICAL)**

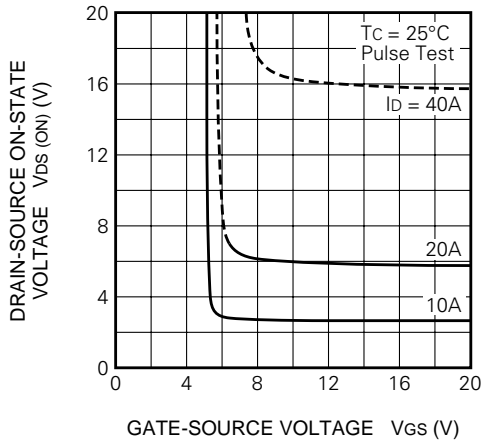

**ON-STATE RESISTANCE VS. DRAIN CURRENT (TYPICAL)**

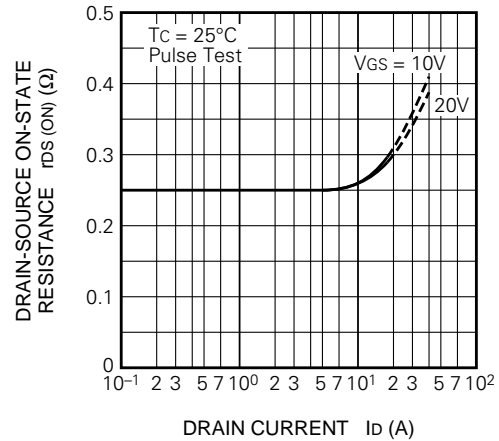

**TRANSFER CHARACTERISTICS (TYPICAL)**

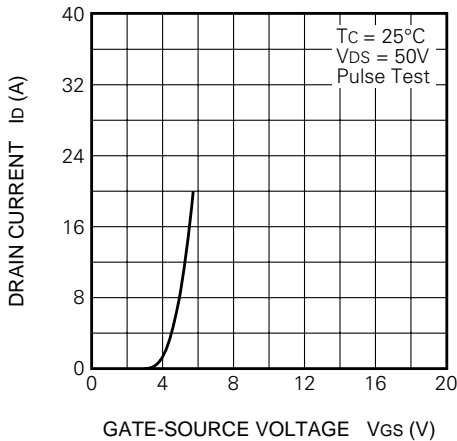

**FORWARD TRANSFER ADMITTANCE VS. DRAIN CURRENT (TYPICAL)**

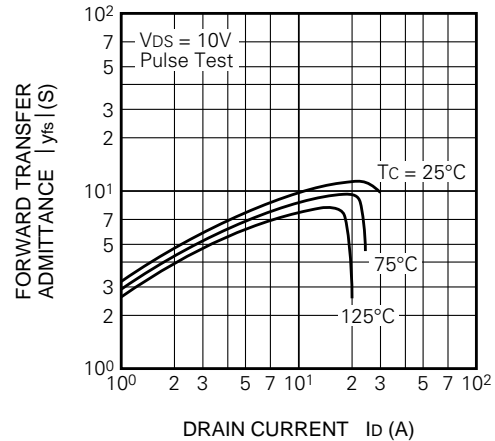

**CAPACITANCE VS. DRAIN-SOURCE VOLTAGE (TYPICAL)**

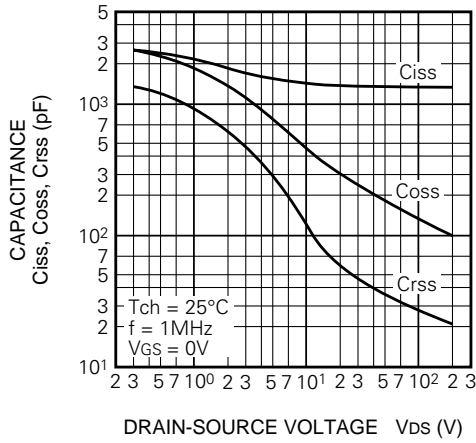

**SWITCHING CHARACTERISTICS (TYPICAL)**

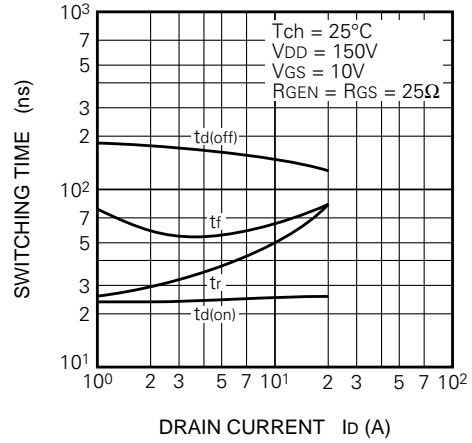

**GATE-SOURCE VOLTAGE VS. GATE CHARGE (TYPICAL)**

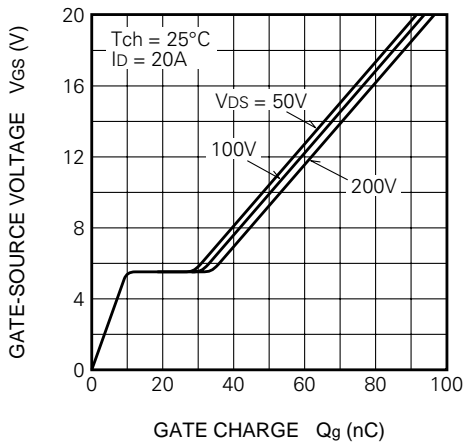

**SOURCE-DRAIN DIODE FORWARD CHARACTERISTICS (TYPICAL)**

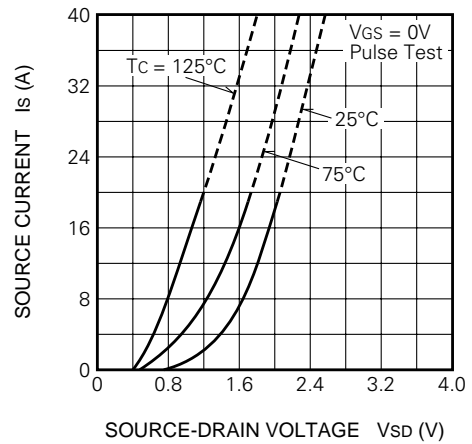

**ON-STATE RESISTANCE VS. CHANNEL TEMPERATURE (TYPICAL)**

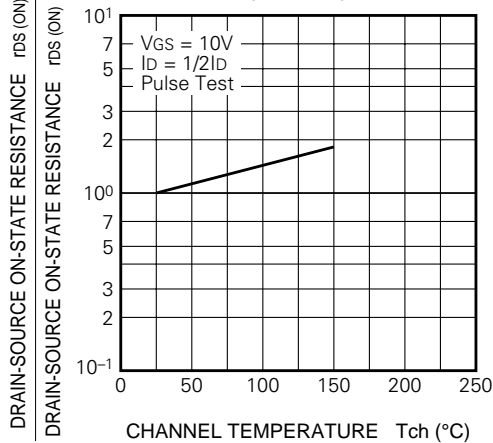

**THRESHOLD VOLTAGE VS. CHANNEL TEMPERATURE (TYPICAL)**

