



Micro Commercial Components
 21201 Itasca Street Chatsworth
 CA 91311
 Phone: (818) 701-4933
 Fax: (818) 701-4939

ER10A THRU ER10G

**10 Amp
Super Fast Recovery
Rectifier
50 to 400 Volts**

Features

- High Surge Capability
- Low Forward Voltage Drop
- High Current Capability
- Super Fast Switching Speed For High Efficiency

Maximum Ratings

- Operating Temperature: -55°C to +150°C
- Storage Temperature: -55°C to +150°C

MCC Part Number	Maximum Recurrent Peak Reverse Voltage	Maximum RMS Voltage	Maximum DC Blocking Voltage
ER10A	50V	35V	50V
ER10B	100V	70V	100V
ER10D	200V	140V	200V
ER10G	400V	280V	400V

Electrical Characteristics @ 25°C Unless Otherwise Specified

Average Forward Current	$I_{F(AV)}$	10 A	$T_A = 55^\circ\text{C}$
Peak Forward Surge Current	I_{FSM}	200A	8.3ms, half sine
Maximum Instantaneous Forward Voltage	V_F	1.0V	$I_{FM} = 10.0\text{A}; T_A = 25^\circ\text{C}$
Maximum DC Reverse Current At Rated DC Blocking Voltage	I_R	10.0 μA	$T_A = 25^\circ\text{C}$
Maximum Reverse Recovery Time ER10A-ER10D ER10G	T_{rr}	35ns 60ns	$I_F=0.5\text{A}, I_R=1.0\text{A}, I_{rr}=0.25\text{A}$

*Pulse Test: Pulse Width 300 μsec , Duty Cycle 1%

DO-214AB (SMCJ) (Round Lead)

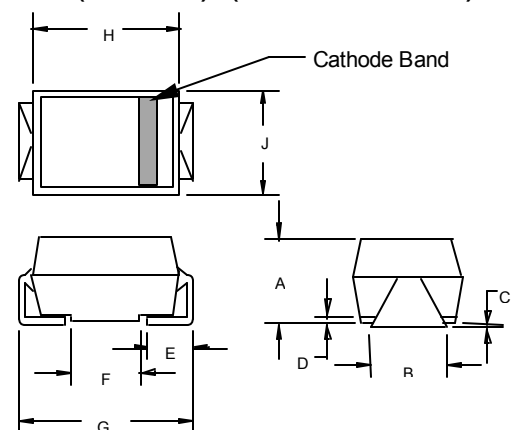

DIM	INCHES		MM		NOTE
	MIN	MAX	MIN	MAX	
A	.200	.214	5.08	5.43	
B	.177	.203	4.70	5.30	
C	.002	.005	.05	.13	
D	—	.02	—	.51	
E	.053	.067	1.35	1.70	
F	.168	.179	4.27	4.55	
G	.320	.330	8.13	8.38	
H	.239	.243	6.08	6.18	
J	.234	.240	5.95	6.10	

SUGGESTED SOLDER PAD LAYOUT

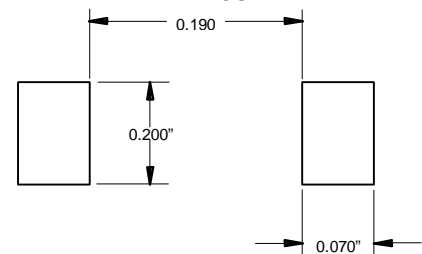

ER10A thru ER10G

Figure 1
Typical Forward Characteristics

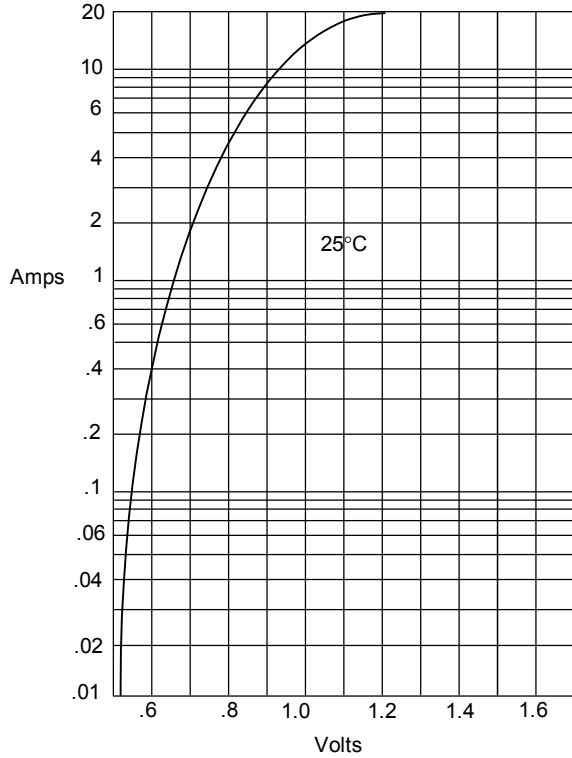

Instantaneous Forward Current - Amperes versus
Instantaneous Forward Voltage - Volts

Figure 2
Forward Derating Curve

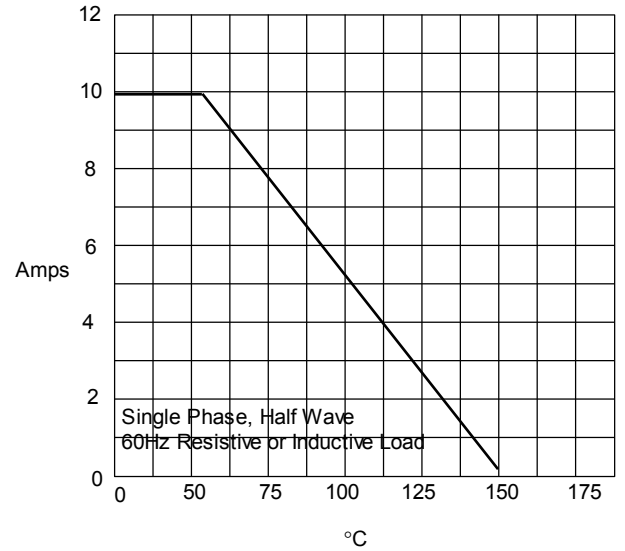
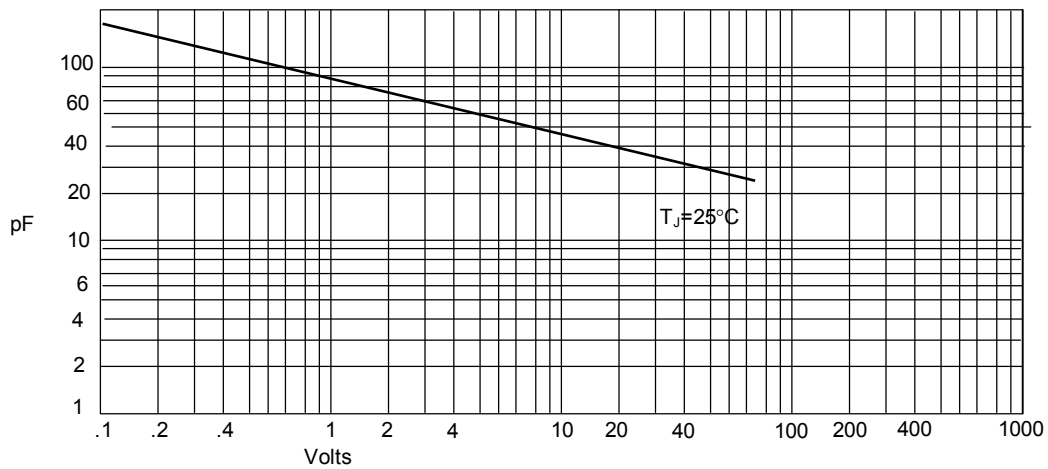

Figure 3
Junction Capacitance



Junction Capacitance - pF versus
Reverse Voltage - Volts

ER10A thru ER10G

Figure 4
Peak Forward Surge Current

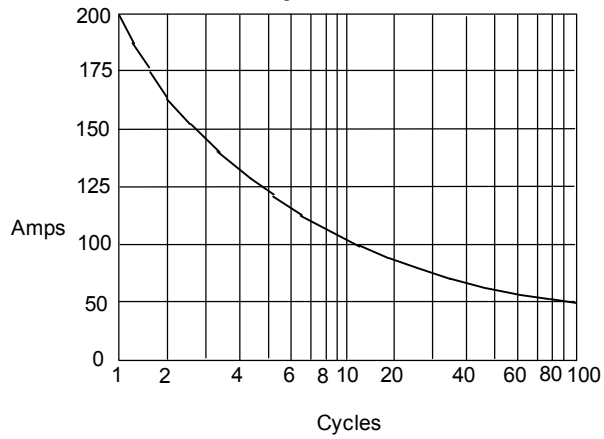

Peak Forward Surge Current - Amperes versus
Number Of Cycles At 60Hz - Cycles

Figure 5
Reverse Recovery Time Characteristic And Test Circuit Diagram

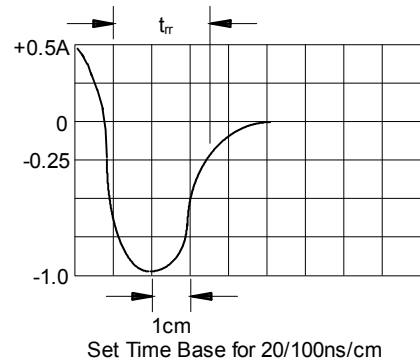
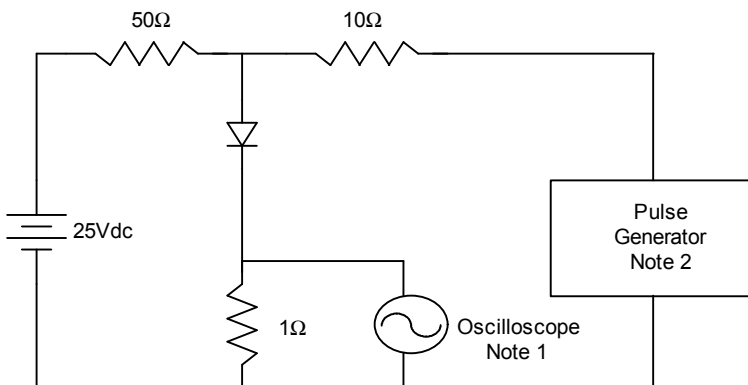

- Notes:
1. Rise Time = 7ns max.
Input impedance = 1 megohm, 22pF
 2. Rise Time = 10ns max.
Source impedance = 50 ohms
 3. Resistors are non-inductive