



Title	<i>Engineering Prototype Report for EP-93 – 32 W/81 W Peak Supply Using PeakSwitch™ (PKS606Y)</i>
Specification	90-265 VAC Input, 30 V, 1.07 A (continuous), 2 A (100 ms), 2.7 A (50 ms) Output
Application	Printers, DVRs, Audio, General Purpose
Author	Power Integrations Applications Department
Document Number	EPR-93
Date	22-Jun-2006
Revision	1.4

Summary and Features

- *EcoSmart*® – meets all existing and proposed harmonized energy efficiency standards including: CECP (China), CEC, EPA, AGO, European Commission
 - No-load power consumption 200 mW at 265 VAC
 - 81.8% active-mode efficiency (exceeds requirement of 80.2%)
- Tight tolerance I^2t parameter (-10%/+12%) reduces system cost:
 - Increases MOSFET and magnetics power delivery
 - Reduces worst-case overload power, which lowers component costs
 - Allows small EE25 core size
- Integrated *PeakSwitch* safety/reliability features:
 - Accurate ($\pm 5\%$), auto-recovering, hysteretic thermal shutdown function maintains safe PCB temperatures under all conditions
 - Auto-restart protects against output short circuits and open feedback loops
 - Adaptive current limit reduces output overload power
 - Programmable smart AC line sensing provides latching shutdown during short circuit, overload and open loop faults and prevents power ON/OFF glitches during power down or brownout
- Meets EN55022 and CISPR-22 Class B conducted EMI with >14 dB μ V margin
- Meets IEC61000-4-5 Class 3 AC line surge

Power Integrations

5245 Hellyer Avenue, San Jose, CA 95138 USA.

Tel: +1 408 414 9200 Fax: +1 408 414 9201

www.powerint.com

The products and applications illustrated herein (including circuits external to the products and transformer construction) may be covered by one or more U.S. and foreign patents or potentially by pending U.S. and foreign patent applications assigned to Power Integrations. A complete list of Power Integrations' patents may be found at www.powerint.com.



Table Of Contents

1	Introduction	5
2	Power Supply Specification	6
3	Schematic	7
4	Circuit Description	8
4.1	Input EMI Filtering	8
4.2	<i>PeakSwitch</i> Primary	8
4.3	Output Rectification and Filtering	9
4.4	Output Feedback	9
4.5	Output Protection	9
5	PCB Layout	10
6	Bill Of Materials	11
7	Transformer Specification	13
7.1	Electrical Diagram	13
7.2	Electrical Specifications	13
7.3	Materials	14
7.4	Transformer Build Diagram	14
7.5	Transformer Construction	15
8	Transformer Spreadsheet	16
9	Performance Data	19
9.1	Efficiency	19
9.1.1	Active Mode CEC Measurement Data	19
9.2	No-load Input Power	21
9.3	Available Standby Output Power	21
9.4	Regulation	22
9.4.1	Load Regulation	22
9.4.2	Line Regulation	22
10	Thermal Performance	23
11	Waveforms	24
11.1	Drain Voltage and Current, Normal Operation	24
11.2	Output Voltage Start-up Profile	24
11.3	Drain Voltage and Current Start-up Profile	25
11.4	Load Transient Response (1 A to 2 A Load Step)	25
11.5	Holdup Time	26
11.6	AC Line Disturbance	27
12	Output Ripple Measurements	30
12.1.1	Ripple Measurement Technique	30
12.1.2	Measurement Results	31
13	Output Over-current Shutdown/Restart	32
14	Line Surge	33
15	Conducted EMI	34
16	Appendix	36
16.1	Heat Sink Drawing	36
17	Revision History	37



Important Note:

Although this board is designed to satisfy safety isolation requirements, the engineering prototype has not been agency approved. Therefore, all testing should be performed using an isolation transformer to provide the AC input to the prototype board.



1 Introduction

This document is an engineering report describing a 90-265 VAC input, 30 V, 1.07 A continuous, 2.7 A peak output power supply utilizing a PKS606Y. This power supply is intended as a general-purpose evaluation platform for *PeakSwitch*, and is ideal for applications where a significant pulsed output load is required, such as printers, audio amplifiers, DVRs and DC motor drives.

The document contains the power supply specification, schematic, bill of materials, transformer documentation, printed circuit layout, and performance data.

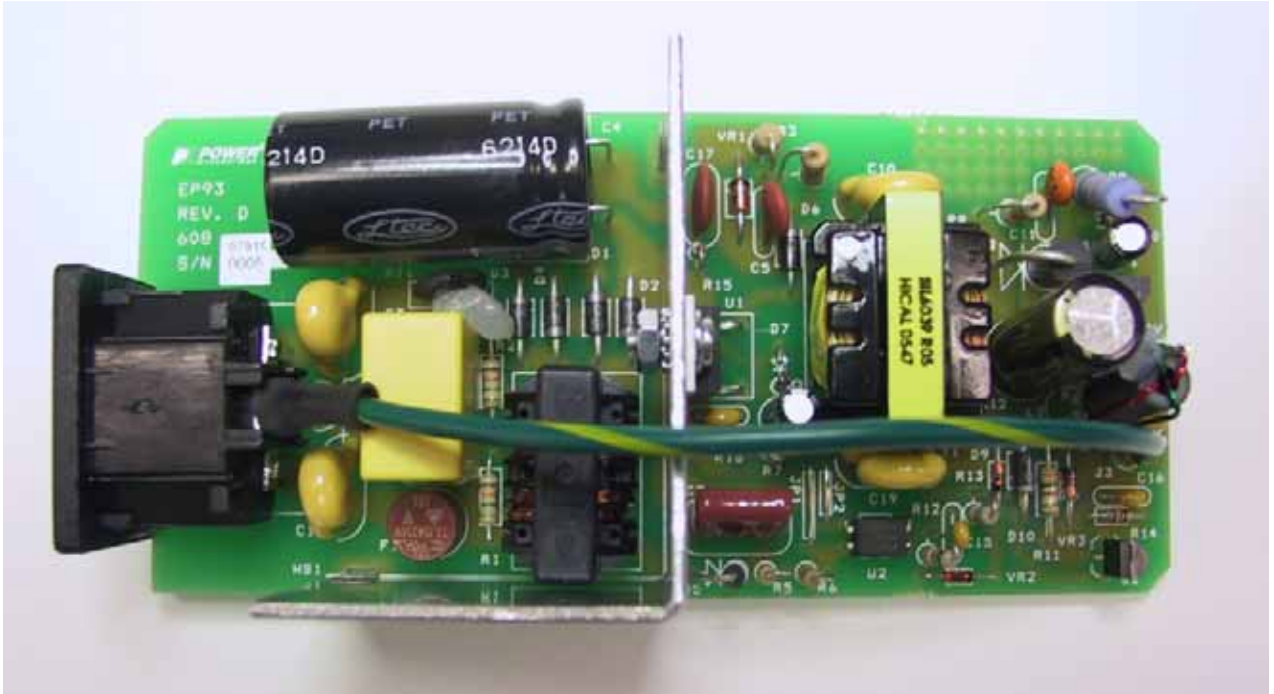

Figure 1 – EP-93 Populated Circuit Board Photograph.

2 Power Supply Specification

Description	Symbol	Min	Typ	Max	Units	Comment
Input						
Voltage	V_{IN}	90		265	VAC	2 Wire – no P.E.
Frequency	f_{LINE}	47	50/60	64	Hz	
No-Load Input Power (230 VAC)				0.2	W	
Output						
Output Voltage	V_{OUT1}	27	30	33	V	± 10% 20 MHz bandwidth
Output Ripple Voltage	$V_{RIPPLE1}$			400	mV	
Output Current	I_{OUT1}	0	1.07	2.71	A	
Total Output Power						
Continuous Output Power	P_{OUT}		32		W	
Peak Output Power	P_{OUT_PEAK}			81	W	
Efficiency						
Full Load	η		82		%	Measured at P_{OUT} , 25 °C Per California Energy Commission (CEC) / ENERGY STAR requirements
Required average efficiency at 25, 50, 75 and 100 % of P_{OUT}	η_{CEC}	80.2			%	
Environmental						
Conducted EMI		Meets CISPR22B / EN55022B				1.2/50 μ s surge, IEC 1000-4-5, Series Impedance: Differential Mode (D): 2 Ω Common Mode (C): 12 Ω
Safety		Designed to meet IEC950, UL1950 Class II				
Surge		1 (D) 2 (C)			kV	
Surge		1 (D) 2 (C)			kV	100 kHz ring wave, 500 A short circuit current, differential (D) and common mode (C)
Ambient Temperature	T_{AMB}	0		50	°C	Free convection, sea level



3 Schematic

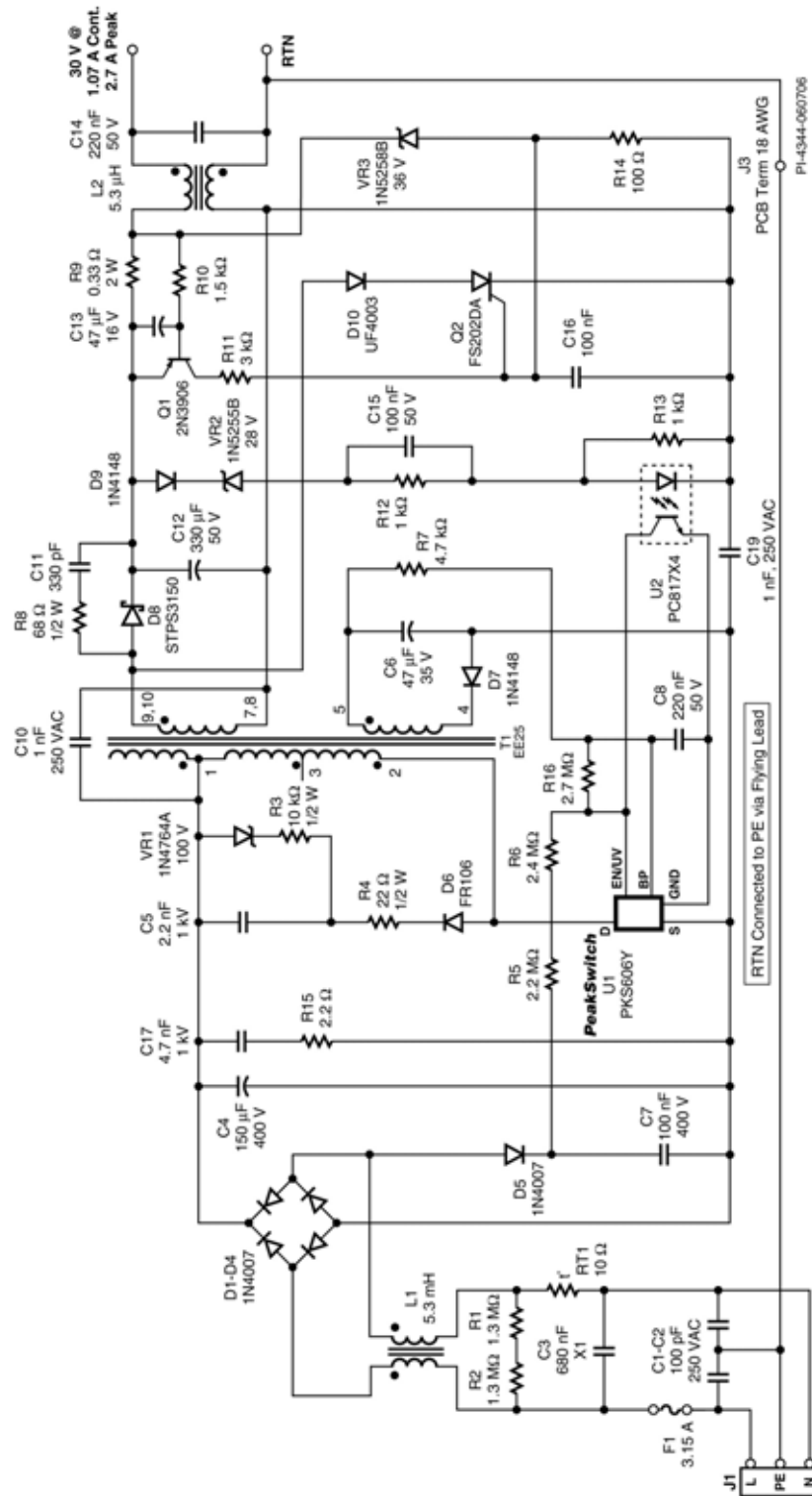

Figure 2 – EP-93 Schematic.



4 Circuit Description

4.1 Input EMI Filtering

Components C1, C2, C3, C10, C17, C19, R15, L1, and L2 provide common mode and differential mode EMI filtering. The use of two Y capacitors (C10 and C19) together with an output common choke (L2) and the frequency jitter feature of *PeakSwitch* allows the supply to meet EN55022B conducted EMI limits even with the output connected directly to safety earth ground. On the PCB layout C19 is placed so that the primary side is connected as close to the bulk capacitor as possible to route surge currents away from U1. Resistors R1 and R2 discharge C3 when AC power is removed.

4.2 PeakSwitch Primary

Components D5, C7, and R5, R6 provide AC line and under voltage sensing for *PeakSwitch* U1. At startup, switching is inhibited until the input voltage is above the under-voltage threshold, determined when a current $>25 \mu\text{A}$ flows into the EN/UV pin. Once the threshold is exceeded, the under-voltage status is not checked until auto-restart is triggered (no feedback for 30 ms). This allows the supply to continue to operate even below the under-voltage threshold as long as the output remains in regulation, maximizing hold-up time.

The separate AC sense network of D5 and C7 allows the *PeakSwitch* to determine the cause of loss of regulation. If the input voltage is above the under-voltage threshold, then a fault condition is assumed. In this case *PeakSwitch* will latch off. If the input voltage is below the under-voltage threshold then loss of regulation was due to a low line condition and *PeakSwitch* will stop switching (but not latch off) until the under-voltage threshold is exceeded again.

Once latched off, the supply can be reset by removing the AC input such that C7 discharges and the current into the EN/UV pin falls below $25 \mu\text{A}$. The under-voltage function can be disabled by removing R6. Resistor R16 provides a small amount of bias to the U1 EN/UV pin to keep the under-voltage lockout function activated during brownout conditions when C7 may discharge.

Diode D7, C6, C8, and R7 provide bias power and decoupling to U1.

Diode D6, C5, R3, R4, and VR1 clamp the U1 drain voltage to safe levels. Use of a moderately slow diode ($t_{\text{RR}} \leq 500 \text{ ns}$) for D6 increases power supply efficiency.



4.3 Output Rectification and Filtering

The secondary of the transformer is rectified and filtered by D8 and C12. As the peak load condition is of short duration, the output capacitor ripple current rating is appropriate for the continuous output current. As capacitor lifetime is a function of temperature rise, this can be used to determine if the capacitor rating (ESR and ripple current specification) is acceptable. Resistor R8 and capacitor C11 are fitted to reduce high frequency EMI.

4.4 Output Feedback

Diodes D9 and VR2, along with the forward drop of the LED of optocoupler U2, set the output voltage of the power supply. Resistor R13 provides a bias current through D9 and VR2 to improve regulation by operating VR2 closer to its knee and test current. Resistor R12 sets the overall gain of the feedback loop while capacitor C15 boosts high frequency loop gain to reduce pulse grouping. A high gain (300-600%) optocoupler U2 is used to reduce control loop delays.

4.5 Output Protection

Components Q1, Q2, R9 to R11, R14, C13, C16, D10, and VR3 are used for latching overvoltage and overcurrent protection in conjunction with the smart AC sensing feature, to shut down the supply in a fault condition. If either an output overvoltage (e.g. optocoupler failure), or overcurrent (e.g. motor stall) fault occurs, SCR Q2 is fired, shorting the output winding. The SCR is connected directly to the secondary winding to allow a lower current rating and lower cost device to be used, as the SCR does not have to discharge the output capacitor.

The value of VR3 is selected to give the desired overvoltage trigger threshold. For overcurrent protection, the value of R9 is selected to turn on Q1 at the desired overcurrent threshold while R10 and C13 provide a time constant, to prevent short duration (~200 ms) transient loads from triggering shutdown.

The shutdown condition can be reset by briefly removing AC power for ~3 seconds (maximum), the time required for C7 to discharge and the current into the EN/UV pin to fall below 25 μ A.



5 PCB Layout

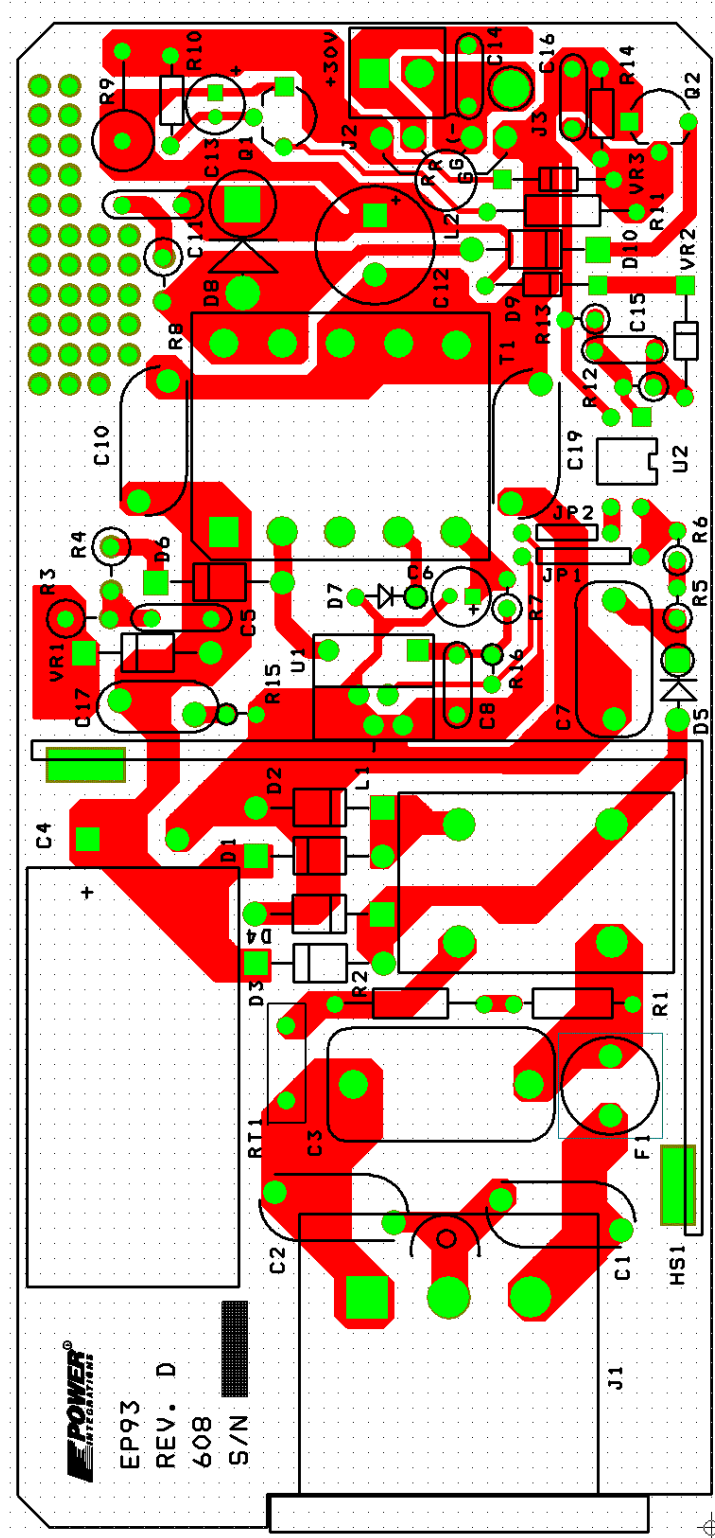

Figure 3 – EP-93 Printed Circuit Layout.



6 Bill of Materials

Item	Qty	Part Ref	Description	Mfg Part Number	Mfg
1	2	C1 C2	100 pF, Ceramic, Y1	ECK-DNA101MB	Panasonic
2	1	C3	680 nF, 275 VAC, Film, X2	PX684K3ID6	Carli
3	1	C4	150 μ F, 400 V, Electrolytic, (18 x 35.5)	YSD2GM151L32B0 BAI0264	Luminous Town
4	1	C5	2.2 nF, 1 kV, Disc Ceramic	5GAD22	Vishay
5	1	C6	47 μ F, 35 V, Electrolytic, Gen Purpose, (5 x 11)	ECA-1VHG470	Panasonic
6	1	C7	100 nF, 400 V, Film	ECQ-E4104KF	Panasonic
7	2	C8 C14	220 nF, 50 V, Ceramic, Z5U, 0.2" L.S.	C322C224M5U5CA	Kemet
8	2	C10 C19	1 nF, Ceramic, Y1	ECK-DNA102MB	Panasonic
9	1	C11	330 pF, 1 kV, Disc Ceramic	5GAT33	Vishay
10	1	C12	330 μ F, 50 V, 22 m Ω , Electrolytic, (10 x 25)	EEU-FM1H331L	Panasonic
11	1	C13	47 μ F, 16 V, Electrolytic, Gen Purpose, (5 x 11.5)	ECA-1CHG470	Panasonic
12	2	C15 C16	100 nF, 50 V, Ceramic, Z5U	C317C104M5U5CA	Kemet
13	1	C17	4700 pF, 1 kV, Thru-hole, Disc Ceramic	5GAD47	Vishay/Sprague
14	5	D1 D2 D3 D4 D5	1000 V, 1 A, Rectifier, DO-41	1N4007	Vishay
15	1	D6	800 V, 1 A, Fast Recovery Diode, 500 ns, DO-41	FR106	Diodes Inc.
16	2	D7 D9	75 V, 300 mA, Fast Switching, DO-35	1N4148	Vishay
17	1	D8	150 V, 3 A, Schottky, DO-201AD	STPS3150RL	ST
18	1	D10	200 V, 1 A, Ultrafast Recovery, 50 ns, DO-41	UF4003	Vishay
19	1	F1	3.15 A, 250 V, Slow, TR5	3,821,315,0410	Wickman
20	1	HS1	HEATSINK/Alum, TO-220 1-hole, 2 Mtg Pins	Custom	Clark Precision Sheetmetal
21	1	J1	AC Input Receptacle and Accessory Plug, PCBM	161-R301SN13	Kobiconn
22	1	J2	2 Position (1 x 2) header, 0.156-pitch, Vertical	26-48-1021	Molex
23	1	J3	PCB Terminal Hole, 18 AWG	N/A	N/A
24	1	JP1	Wire Jumper, Non-insulated, 22 AWG, 0.4 in	298	Alpha
25	1	JP2	Wire Jumper, Non-insulated, 22 AWG, 0.3 in	298	Alpha
26	1	L1	5.3 mH, 1 A, Common Mode Choke	ELF15N010A	Panasonic
27	1	L2	5.3 μ H, 4 A, Common Mode Choke Bead	Custom	
28	1	U1 (REF)	Nut, Hex, Kep 4-40, Zinc Plate		
29	1	Q1	PNP, Small Signal BJT, 40 V, 0.2 A, TO- 92	2N3906	Vishay
30	1	Q2	SCR, 400 V, 1.25 A, TO-92	FS0202DA	Fagor
31	2	R1 R2	1.3 M Ω , 5%, 1/4 W, Carbon Film	CFR-25JB-1M3	Yageo
32	1	R3	10 k Ω , 5%, 1/2 W, Carbon Film	CFR-50JB-10K	Yageo
33	1	R4	22 Ω , 5%, 1/2 W, Carbon Film	CFR-50JB-22R	Yageo



34	1	R5	2.2 M Ω , 5%, 1/4 W, Carbon Film	CFR-25JB-2M2	Yageo
35	1	R6	2.4 M Ω , 5%, 1/4 W, Carbon Film	CFR-25JB-2M4	Yageo
36	1	R7	4.7 k Ω , 5%, 1/4 W, Carbon Film	CFR-25JB-4K7	Yageo
37	1	R8	68 Ω , 5%, 1/2 W, Carbon Film	CFR-50JB-68R	Yageo
38	1	R9	0.33 Ω , 5%, 2 W, Metal Oxide	RS2 0.33 5% A	Stackpole/Sei
39	1	R10	1.5 k Ω , 5%, 1/8 W, Carbon Film	CFR-12JB-1K5	Yageo
40	1	R11	3 k Ω , 5%, 1/4 W, Carbon Film	CFR-25JB-3K0	Yageo
41	2	R12 R13	1 k Ω , 5%, 1/4 W, Carbon Film	CFR-25JB-1K0	Yageo
42	1	R14	100 Ω , 5%, 1/8 W, Carbon Film	CFR-12JB-91R	Yageo
43	1	R15	2.2 Ω , 5%, 1/8 W, Carbon Film	CFR-12JB-2R2	Yageo
44	1	R16	2.7 M Ω , 5%, 1/8 W, Carbon Film	CFR-12JB-2M7	Yageo
45	1	RT1	NTC Thermistor, 10 Ω , 1.7 A	CL-120	Thermometrics
46	1	U1 (REF)	SCR, Phillips, 4-40 X 5/16 Pan-head Machine Screw, Steel, Zinc Plate		
47	1	T1	Transformer, EE25, 10 Pins, Vertical	SIL6039 LSPA10545 SNX1882	Hi Cal LiShin Santronics
48	1	U1	<i>PeakSwitch</i> , PKS606Y, TO-220-7C	PKS606Y	Power Integrations
49	1	U2	Optocoupler, 35 V, CTR 300-600%, 4-DIP	PC817X4	Sharp
50	1	VR1	100 V, 5%, 1 W, DO-41	1N4764A	Microsemi
51	1	VR2	28 V, 5%, 500 mW, DO-35	1N5255B	Microsemi
52	1	VR3	36 V, 5%, 500 mW, DO-35	1N5258B	Microsemi
53	1	U1 (REF)	Washer Flat #4, Zinc Plated	#4FWZ	Building Fasteners
54	1		PCB, EP-93, REVD		
55	1	J1 (REF)	Wire, UL1015, 18 AWG, GRN/YEL	8918-189	Belden
56	1	J1 (REF)	Heat Shrink, 1/4-inch, BLK	221014-6BK	Alpha
57	1	J1 (REF)	Snap-in Terminal	02-07-2102	Molex
58	1	U1 (REF)	Silicone Heat Sink Compound		
59	1	C4, RT1, L2 (REF)	Silicone Adhesive, Non-corrosive	19-155	GC Electronics

Note: (REF) indicates mechanical items associated with the referenced component(s) but that are not shown on the schematic.



7 Transformer Specification

7.1 Electrical Diagram

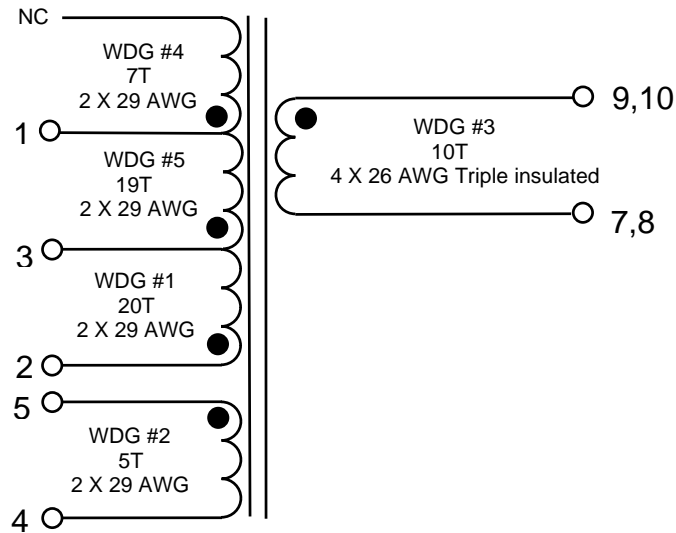

Figure 4 – Transformer Electrical Diagram.

7.2 Electrical Specifications

Electrical Strength	1 Second, from Pins 1-5 to Pins 6-10	3000 VAC, 60 Hz
Creepage	Between Pins 1-5 and Pins 6-10	6 mm (Min.)
Primary Inductance	Pins 1-2, All other Windings Open, Measured at 100 kHz, 0.4 VRMS	132 μ H, \pm 10%
Resonant Frequency	Pins 1-2, All other Windings Open	2 MHz (Min.)
Primary Leakage Inductance	Pins 1-2, with Pins 6-10 Shorted, Measured at 100 kHz, 0.4V RMS	5.5 μ H (Max.)



7.3 Materials

Item	Description
[1]	Core: (EE25) E25/10/6 Ferroxcube 3C90 Material or Equivalent Gapped for A_L of 88 nH/T ²
[2]	Bobbin: 10-pin EE25, Vertical Mount, Yih Hwa YW-360 or Equivalent
[3]	Magnet Wire: #29 AWG Double-coated
[4]	Triple Insulated Wire: #26 AWG
[5]	Tape, 3M #1298 or Equivalent 10.8 mm Wide
[6]	Varnish

7.4 Transformer Build Diagram

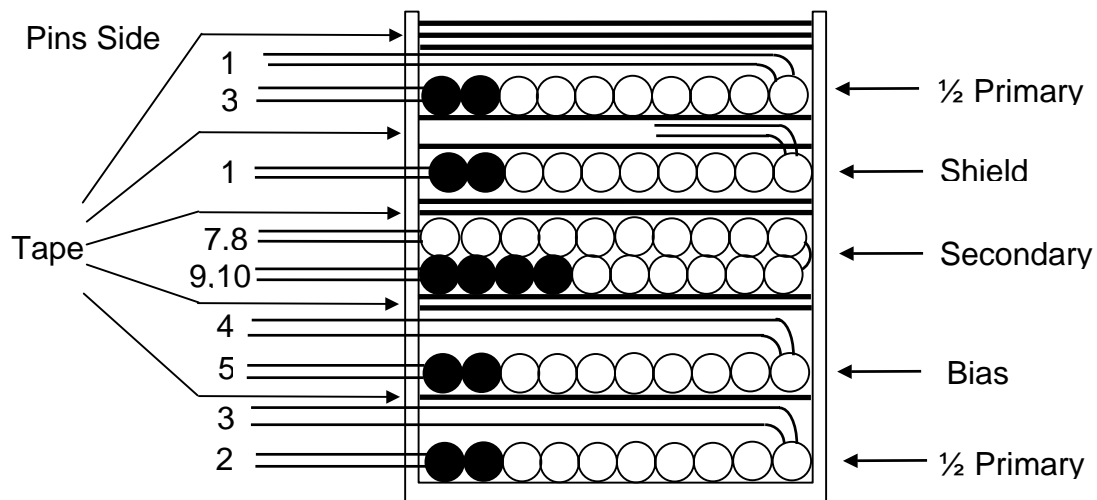

Figure 5 – Transformer Build Diagram.

7.5 Transformer Construction

1/2 Primary	Start at Pin 2. Wind 20 bifilar turns of item [3] in approximately 1.25 layer, finish on Pin 3.
Basic Insulation	Use one layer of item [5] for basic insulation.
Bifilar Bias Winding	Starting at Pin 5, wind 5 bifilar turns of item [3]. Spread turns evenly across bobbin. Finish at Pin 4.
Basic Insulation	Use two layers of item [5] for basic insulation.
30 V Quad filar Secondary Winding	Start at Pins 9 and 10. Wind 10 quad filar turns of item [4] (about 2 layers). Spread turns evenly across bobbin. Finish on Pins 7 and 8.
Basic Insulation	Use two layers of item [5] for basic insulation.
Shield	Starting at Pin 1, wind 7 bifilar turns of item [3]. Spread turns evenly across bobbin. Leave 1/2-inch of flying lead at finish.
Basic Insulation	Use two layers of item [5] for basic insulation. Trap flying lead from shield winding between tape layers.
1/2 Primary	Start at Pin 3. Wind 19 bifilar turns of item [3] in approximately 1 layer, finish on Pin 1.
Finish Wrap	Use three layers of item [5] for finish wrap.
Final Assembly	Assemble and secure core halves. Dip Varnish (item [6]).



8 Transformer Spreadsheet

ACDC_PeakSwitch_0 31006; Rev.1.1; ©Copyright Power Integrations 2006		INPUT	INFO	OUTPUT	UNIT	ACDC_PeakSwitch_031006_Rev1-1.xls; PeakSwitch Continuous/Discontinuous Flyback Transformer Design Spreadsheet
ENTER APPLICATION VARIABLES						
VACMIN	90				Volts	Minimum AC Input Voltage
VACMAX	265				Volts	Maximum AC Input Voltage
fL	50				Hertz	AC Mains Frequency
Nominal Output Voltage (VO)	30.00				Volts	Nominal Output Voltage (at continuous power)
Maximum Output Current (IO)	2.71				Amps	Power Supply Output Current (corresponding to peak power)
Minimum Output Voltage at Peak Load	27.00		27.00		Volts	Minimum Output Voltage at Peak Power (Assuming output droop during peak load)
Continuous Power	32.00		32.00		Watts	Continuous Output Power
Peak Power			73.17		Watts	Peak Output Power
n	0.75					Efficiency Estimate at output terminals and at peak load. Enter 0.7 if no better data available
Z			0.60			Loss Allocation Factor (Z = Secondary side losses / Total losses)
tC Estimate	3.00				mSeconds	Bridge Rectifier Conduction Time Estimate
CIN	150.00		150		uFarads	Input Capacitance
ENTER PeakSwitch VARIABLES						
PeakSwitch	PKS606Y		PKS606Y			PeakSwitch device
Chosen Device			<i>PKS606Y</i>			
ILIMITMIN			2.600		Amps	Minimum Current Limit
ILIMITMAX			3.000		Amps	Maximum Current Limit
fSmin			250000		Hertz	Minimum Device Switching Frequency
I ² fmin			1955		A ² kHz	I ² f (product of current limit squared and frequency is trimmed for tighter tolerance)
VOR	120.00		120		Volts	Reflected Output Voltage (VOR <= 135 V Recommended)
VDS	8.00		8		Volts	PeakSwitch on-state Drain to Source Voltage
VD	1.00		1		Volts	Output Winding Diode Forward Voltage Drop
VDB			0.7		Volts	Bias Winding Diode Forward Voltage Drop
VCLO	170		170		Volts	Nominal Clamp Voltage
KP (STEADY STATE)			0.50			Ripple to Peak Current Ratio (KP < 6)
KP (TRANSIENT)			0.30			Ripple to Peak Current Ratio under worst case at peak load (0.25 < KP < 6)
ENTER UVLO VARIABLES						
V_UV_TARGET			89		Volts	Target DC under-voltage threshold, above which the power supply will start
V_UV_ACTUAL			92		Volts	Typical DC start-up voltage based on standard value of RUV_ACTUAL
RUV_IDEAL			3.47		Mohms	Calculated value for UV Lockout resistor
RUV_ACTUAL			3.60		Mohms	Closest standard value of resistor to RUV_IDEAL
BIAS WINDING VARIABLES						
VB			15.00		Volts	Bias winding Voltage
NB			5			Number of Bias Winding Turns
PIVB			63		Volts	Bias Rectifier Maximum Peak Inverse Voltage



ENTER TRANSFORMER CORE/CONSTRUCTION VARIABLES					
Core Type	EE25		EE25		User Selected Core Size(Verify acceptable thermal rise under continuous load conditions)
Core			EE25	P/N:	PC40EE25-Z
Bobbin			EE25_BOBBIN	P/N:	EE25_BOBBIN
AE			0.404	cm ²	Core Effective Cross Sectional Area
LE			7.34	cm	Core Effective Path Length
AL			1420	nH/T ²	Ungapped Core Effective Inductance
BW			10.20	mm	Bobbin Physical Winding Width
M			0.00	mm	Safety Margin Width (Half the Primary to Secondary Creepage Distance)
L				3	Number of Primary Layers
NS		10		10	Number of Secondary Turns
DC INPUT VOLTAGE PARAMETERS					
VMIN				81 Volts	Minimum DC Input Voltage
VMAX				375 Volts	Maximum DC Input Voltage
CURRENT WAVEFORM SHAPE PARAMETERS					
DMAX		ON-Time Extension		0.62	!!! Info. ON-Time Extension feature invoked. Verify this design for acceptable electrical and thermal performance on the bench
I AVG				1.34 Amps	Average Primary Current
IP				2.60 Amps	Minimum Peak Primary Current
IR				1.31 Amps	Primary Ripple Current
IRMS				1.80 Amps	Primary RMS Current
TRANSFORMER PRIMARY DESIGN PARAMETERS					
LP				132 uHenries	Typical Primary Inductance. +/- 10% to ensure a minimum primary inductance of 119 uH
LP_TOLERANCE		10.00		10 %	Primary inductance tolerance
NP				39	Primary Winding Number of Turns
ALG				88 nH/T ²	Gapped Core Effective Inductance
Target BM				3000 Gauss	Target Peak Flux Density at Maximum Current Limit
BM				2523 Gauss	Calculated Maximum Operating Flux Density, BM < 3000 is recommended
BAC				635 Gauss	AC Flux Density for Core Loss Curves (0.5 X Peak to Peak)
ur				2053	Relative Permeability of Ungapped Core
LG				0.54 mm	Gap Length (Lg > 0.1 mm)
BWE				30.6 mm	Effective Bobbin Width
OD				0.79 mm	Maximum Primary Wire Diameter including insulation
INS				0.08 mm	Estimated Total Insulation Thickness (= 2 * film thickness)
DIA				0.71 mm	Bare conductor diameter
AWG				22 AWG	Primary Wire Gauge (Rounded to next smaller standard AWG value)
CM				645 Cmils	Bare conductor effective area in circular mils
CMA				358 Cmils/Amp	Primary Winding Current Capacity (100 < CMA < 500)



TRANSFORMER SECONDARY DESIGN PARAMETERS					
Lumped parameters					
ISP			10.06	Amps	Peak Secondary Current
ISRMS			5.44	Amps	Secondary RMS Current
IRIPPLE			4.72	Amps	Output Capacitor RMS Ripple Current
CMS			1089	Cmils	Secondary Bare Conductor minimum circular mils
AWGS			19	AWG	Secondary Wire Gauge (Rounded up to next larger standard AWG value)
VOLTAGE STRESS PARAMETERS					
VDRAIN			624	Volts	Maximum Drain Voltage Estimate (Assumes 20% zener clamp tolerance and an additional 10% temperature tolerance)
PIVS			127	Volts	Output Rectifier Maximum Peak Inverse Voltage



9 Performance Data

All measurements performed at room temperature, 60 Hz input frequency.

9.1 Efficiency

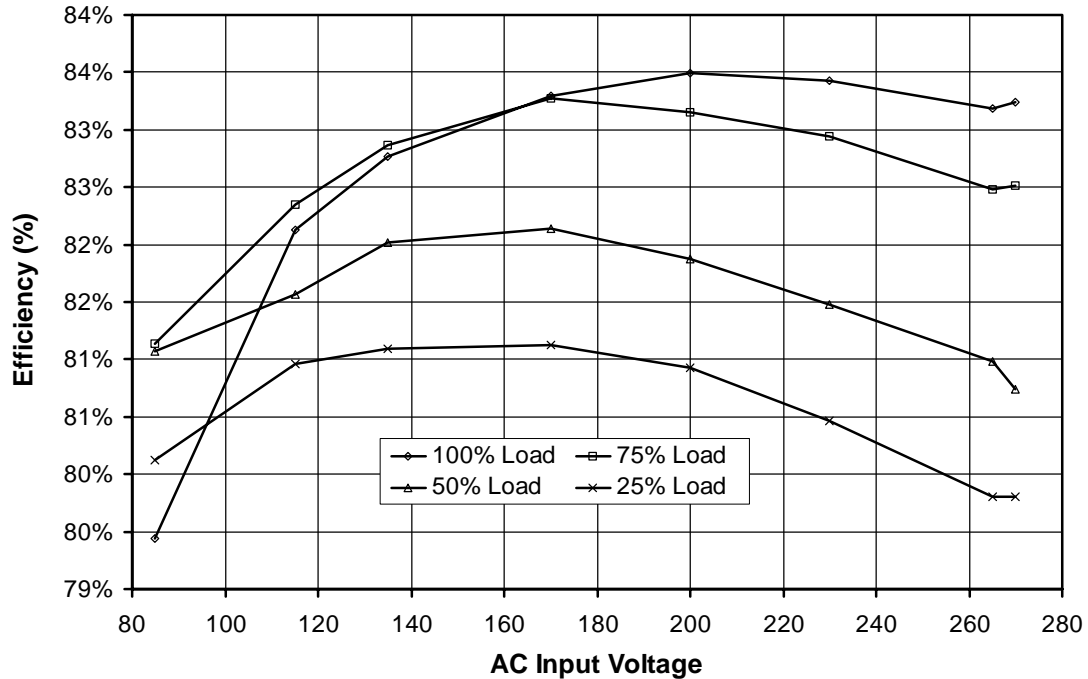

Figure 6 – Efficiency vs. Input Voltage, Room Temperature, 60 Hz.

9.1.1 Active Mode CEC Measurement Data

All single output adapters, including those provided with products for sale in California after July 1st, 2006 must meet the California Energy Commission (CEC) requirement for minimum active mode efficiency and no-load input power. Minimum active mode efficiency is defined as the average efficiency of 25, 50, 75 and 100% of rated output power, with the limit based on the nameplate output power:

Nameplate Output (P _O)	Minimum Efficiency in Active Mode of Operation
< 1 W	0.49 × P _O
≥ 1 W to ≤ 49 W	0.09 × ln (P _O) + 0.49 [ln = natural log]
> 49 W	0.84

For adapters that are single input voltage only, the measurement is made at the rated single nominal input voltage (115 VAC or 230 VAC). For universal input adapters the measurement is made at both nominal input voltages (115 VAC and 230 VAC).



To meet the standard, the measured average efficiency (or efficiencies for universal input supplies) must be greater than or equal to the efficiency specified by the CEC/Energy Star standard.

Percent of Full Load	Efficiency (%)	
	115 VAC	230 VAC
25	81.0%	80.5%
50	81.6%	81.5%
75	82.4%	82.8%
100	82.1%	83.4%
Average	81.8%	82%
CEC specified minimum average efficiency (%)	80.2%	

More states within the USA and other countries are adopting this standard. For the latest up to date information please visit the PI Green Room:

<http://www.powerint.com/greenroom/regulations.htm>



9.2 No-load Input Power

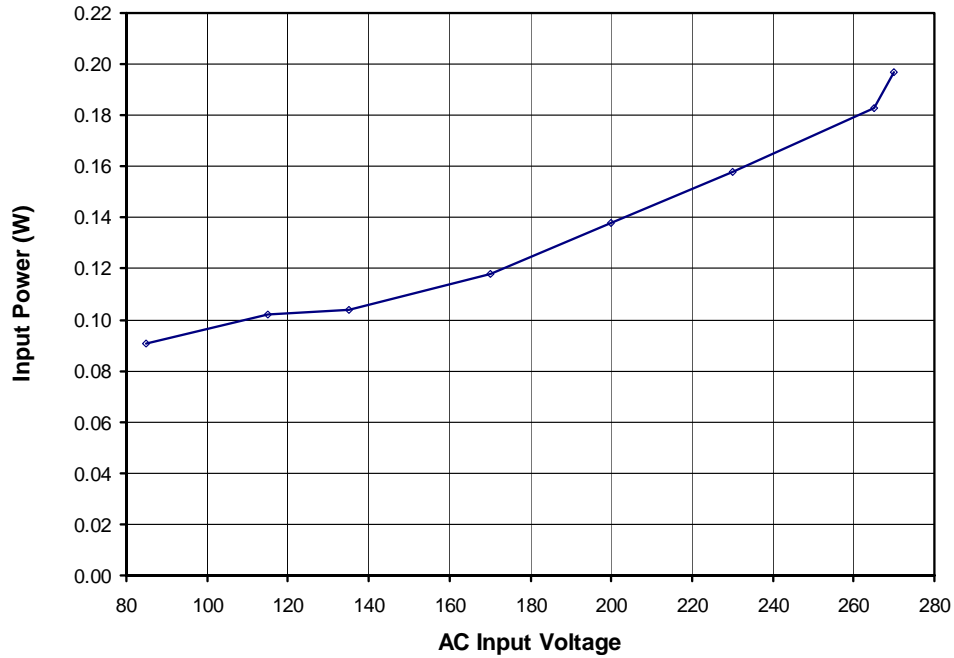

Figure 7 – Zero Load Input Power vs. Input Line Voltage, Room Temperature, 60 Hz.

9.3 Available Standby Output Power

The chart below shows the available output power vs. line voltage for input power levels of 1 W and 3 W.

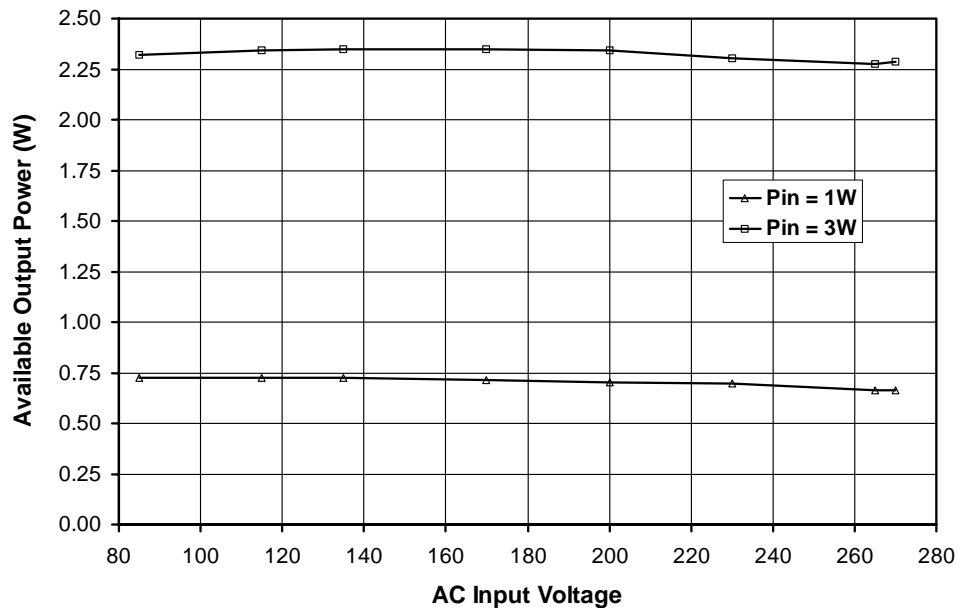

Figure 8 -- Available Output Power vs. Input Voltage for P_{IN} of 1 W and 3 W.



9.4 Regulation

9.4.1 Load Regulation

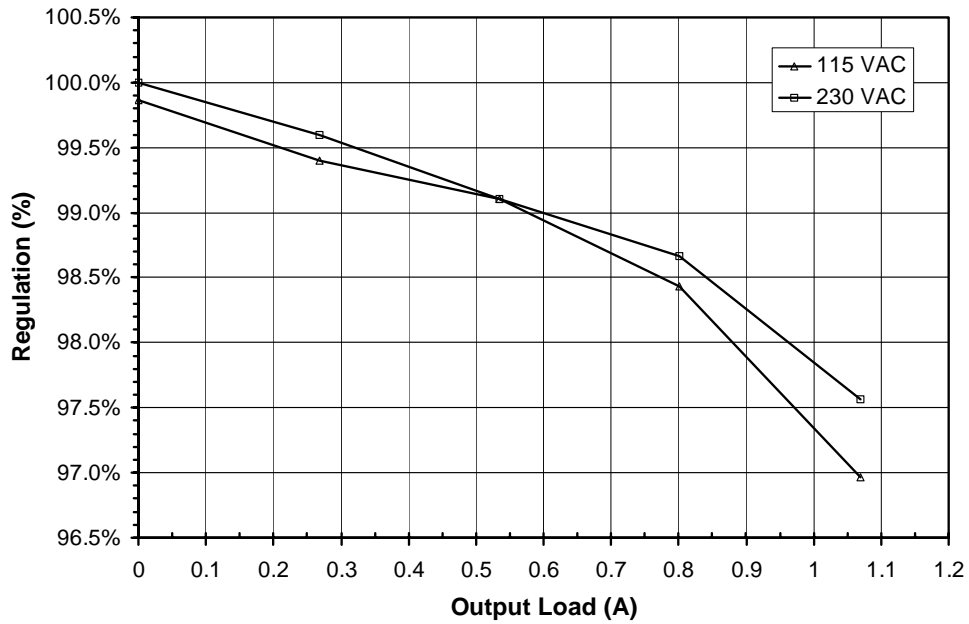

Figure 9 – Output Regulation vs. Load, Room Temperature.

9.4.2 Line Regulation

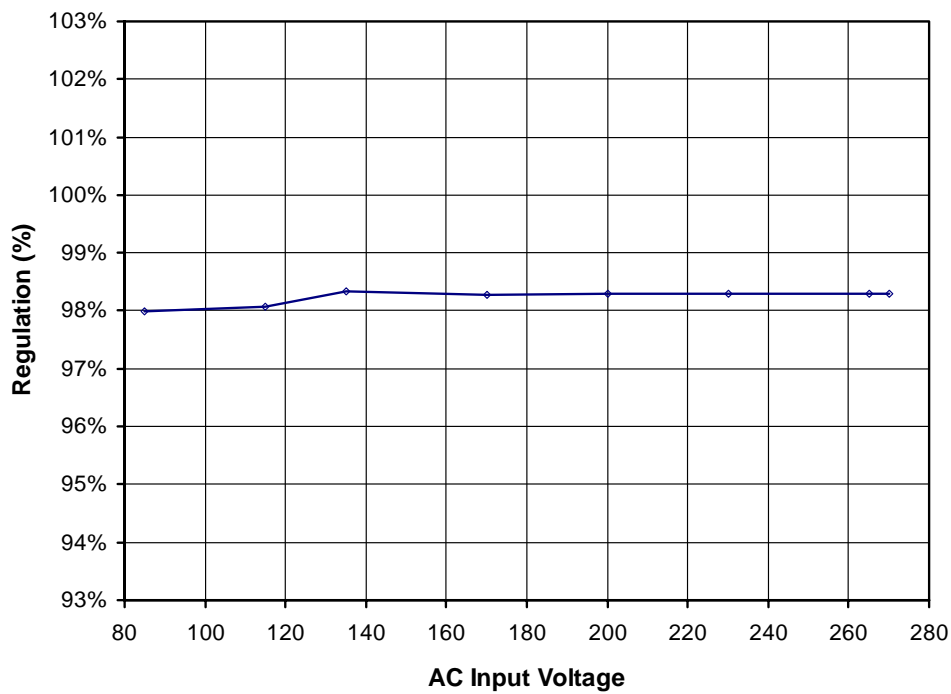

Figure 10 – Line Regulation, Room Temperature, Full Load. (32 W).



10 Thermal Performance

Temperature of key components, open frame room temperature and 85 VAC input.

Item	Temperature (°C)
	85 VAC
Ambient	25.2
D8 (Output Rectifier)	65.8
C12 (Output Capacitor)	47.0
U1 (<i>PeakSwitch</i>)	70.0
T1 (Transformer)	58.0
L1 (Common Mode Choke)	47.0
C4 (Bulk Capacitor)	34.7



11 Waveforms

11.1 Drain Voltage and Current, Normal Operation

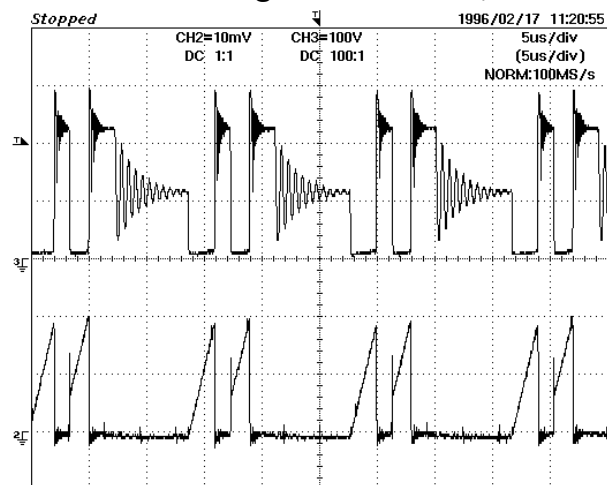

Figure 11 – 90 VAC, Full Load.
Upper: V_{DRAIN} , 100 V / div.
Lower: I_{DRAIN} , 0.5 A, 5 μ s / div.

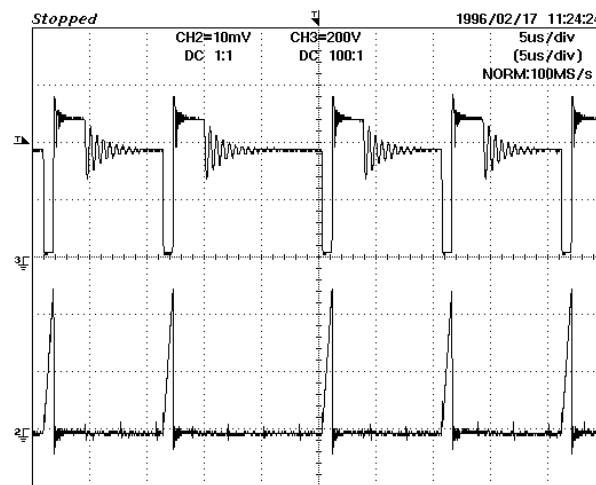

Figure 12 – 265 VAC, Full Load.
Upper: V_{DRAIN} , 200 V / div.
Lower: I_{DRAIN} , 0.5 A, 5 μ s / div.

11.2 Output Voltage Start-up Profile

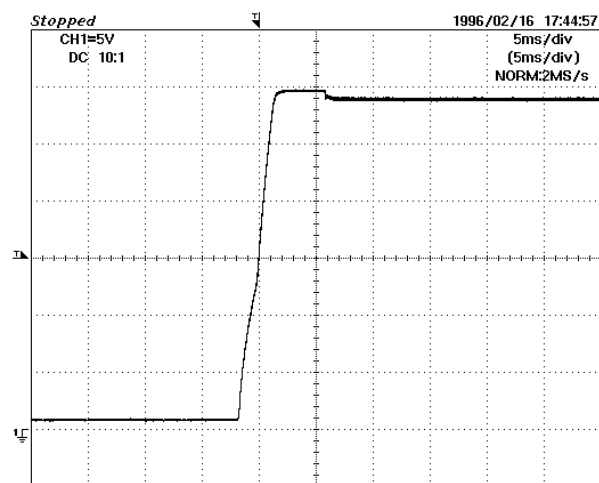

Figure 13 – Start-Up Profile, 90 VAC.
5 V, 5 ms / div.

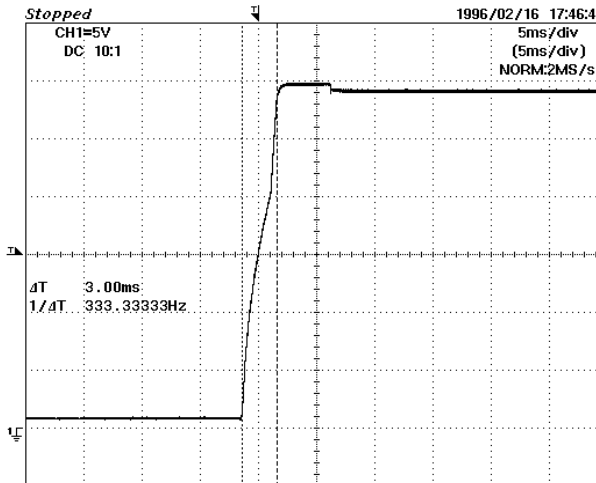

Figure 14 – Start-Up Profile, 265 VAC.
5 V, 5 ms / div.



11.3 Drain Voltage and Current Start-up Profile

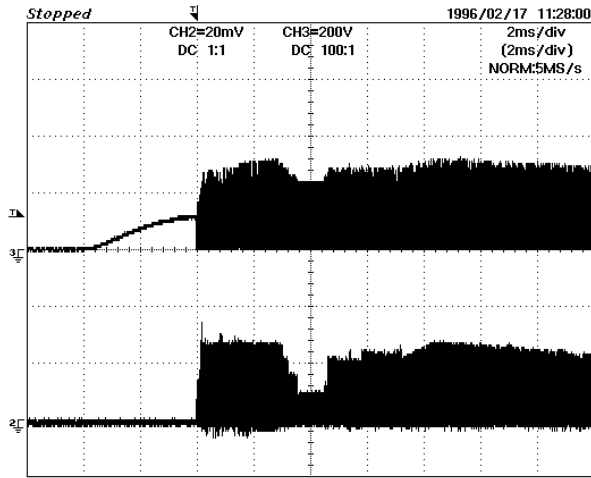

Figure 15 – 90 VAC Input, 32 W Load.
 Upper: V_{DRAIN} , 100 V, 2 ms / div.
 Lower: I_{DRAIN} , 2 A / div.

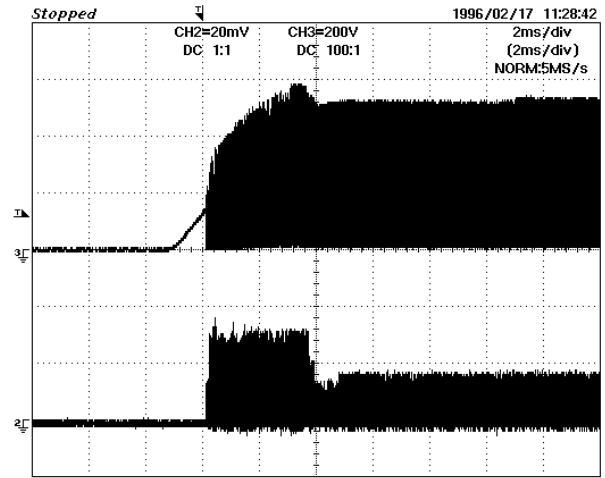

Figure 16 – 265 VAC Input, 32 W Load.
 Upper: V_{DRAIN} , 200 V, 2 ms / div.
 Lower: I_{DRAIN} , 2 A / div.

11.4 Load Transient Response (1 A to 2 A Load Step)

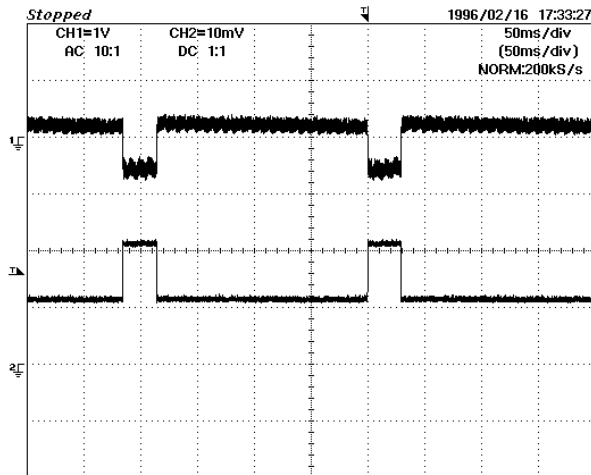

Figure 17 – Transient Response, 90 VAC,
 1 A to 2 A to 1 A Load Step.
 Upper: Output Voltage, 1 V/div.
 Lower: Load Current, 1 A, 50 ms/div.

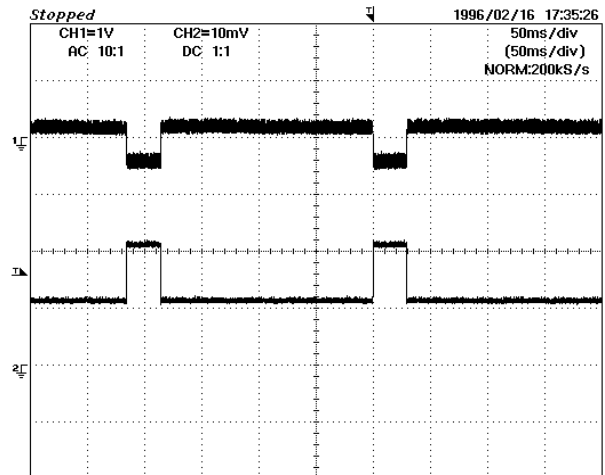

Figure 18 – Transient Response, 265 VAC,
 1 A to 2 A to 1 A Load Step.
 Upper: Output Voltage, 1 V/div.
 Lower: Load Current, 1 A, 50 ms/div.



11.5 Holdup Time

All measurements taken at 32 W output load.

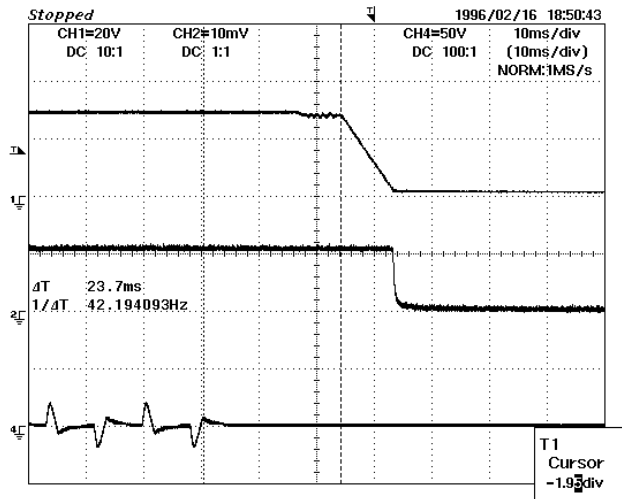

Figure 19 – Holdup Time, 90 VAC.
Top Trace: Output Voltage, 20 V/div.
Middle Trace: Output Current, 1 A/div.
Bottom Trace: AC Input Current, 5 A, 10 ms/div.



11.6 AC Line Disturbance

All measurements taken at 32 W output load.

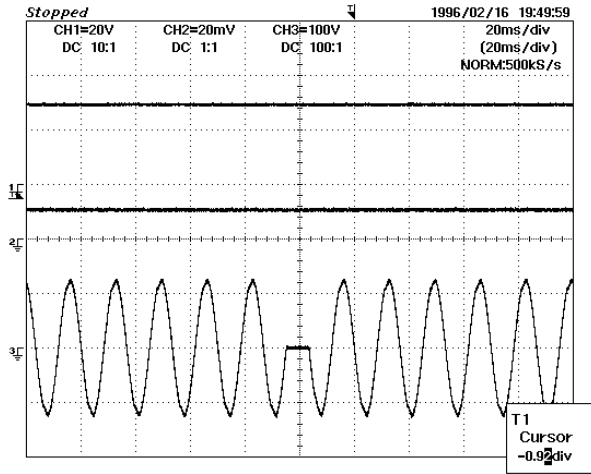

Figure 20 – Half-Cycle Dropout, 90 VAC, 60 Hz.
 Top Trace: Output Voltage, 20 V/div.
 Middle Trace: Output Current, 2 A/div.
 Bottom Trace: AC Input Voltage, 100 V, 20 ms/div.

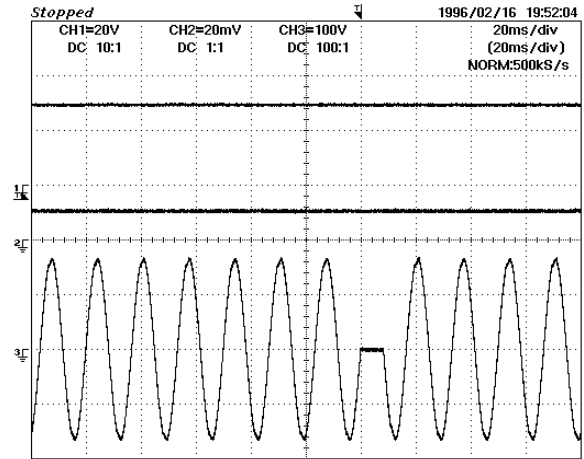

Figure 21 – Half-Cycle Dropout, 120 VAC, 60 Hz.
 Top Trace: Output Voltage, 20 V/div.
 Middle Trace: Output Current, 2 A/div.
 Bottom Trace: AC Input Voltage, 100 V, 20 ms/div.

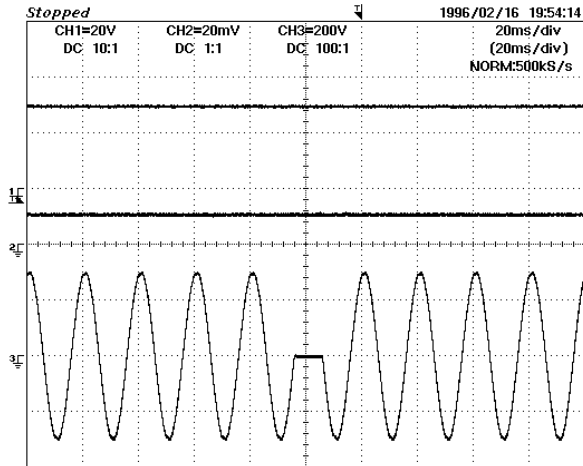

Figure 22 – Half-Cycle Dropout, 216 VAC, 50 Hz.
 Top Trace: Output Voltage, 20 V/div.
 Middle Trace: Output Current, 2 A/div.
 Bottom Trace: AC Input Voltage, 200 V, 20 ms/div.

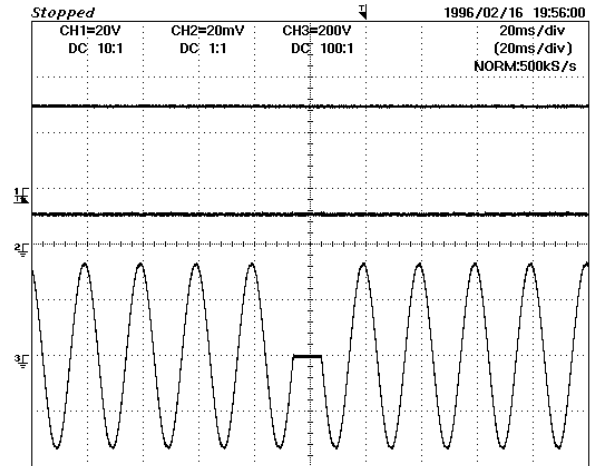

Figure 23 – Half-Cycle Dropout, 240 VAC, 50 Hz.
 Top Trace: Output Voltage, 20 V/div.
 Middle Trace: Output Current, 2 A/div.
 Bottom Trace: AC Input Voltage, 200 V, 20 ms/div.



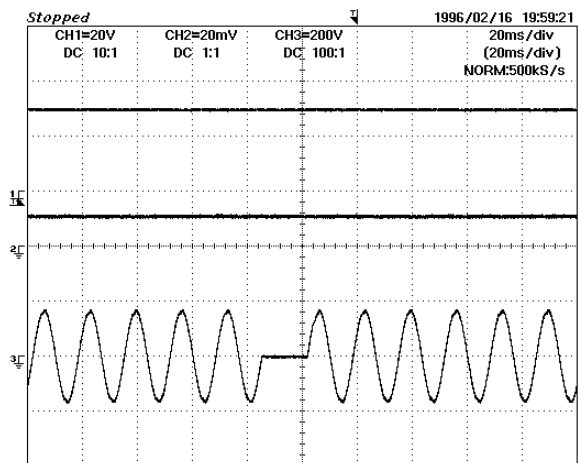

Figure 24 – Full Cycle Dropout, 120 VAC, 60Hz.
 Top Trace: Output Voltage, 20 V/div.
 Middle Trace: Output Current, 2 A/div.
 Bottom Trace: AC Input Voltage, 200 V, 20 ms/div.

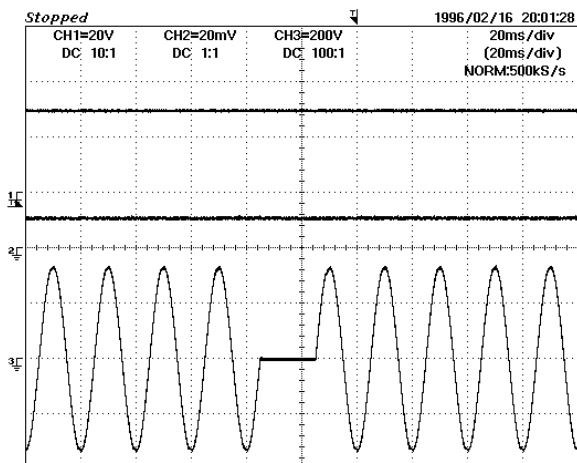

Figure 25 – Full Cycle Dropout, 240 VAC, 50 Hz.
 Top Trace: Output Voltage, 20 V/div.
 Middle Trace: Output Current, 2 A/div.
 Bottom Trace: AC Input Voltage, 200 V, 20 ms/div.

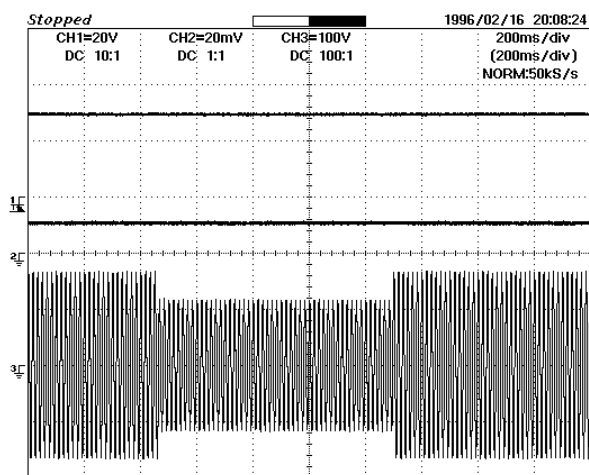

Figure 26 – Line Sag from 120 VAC to 84 VAC (50 cycles), 60 Hz.
 Top Trace: Output Voltage, 20 V/div.
 Middle Trace: Output Current, 2 A/div.
 Bottom Trace: AC Input Voltage, 100 V, 200 ms/div.

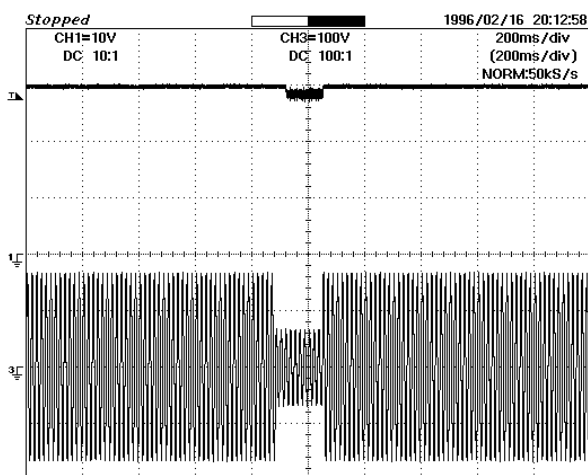

Figure 27 – Line Sag from 120 VAC to 48 VAC (16 cycles), 60 Hz.
 Top Trace: Output Voltage, 10 V/div.
 Bottom Trace: AC Input Voltage, 100 V, 200 ms/div.



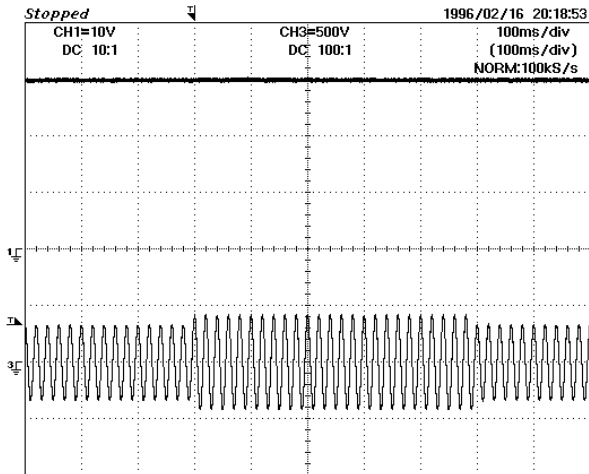

Figure 28 – Line Swell from 240 VAC to 300 VAC (500 msec), 50 Hz.
Top Trace: Output Voltage, 10 V/div.
Bottom Trace: AC Input Voltage, 500 V, 100 ms/div.

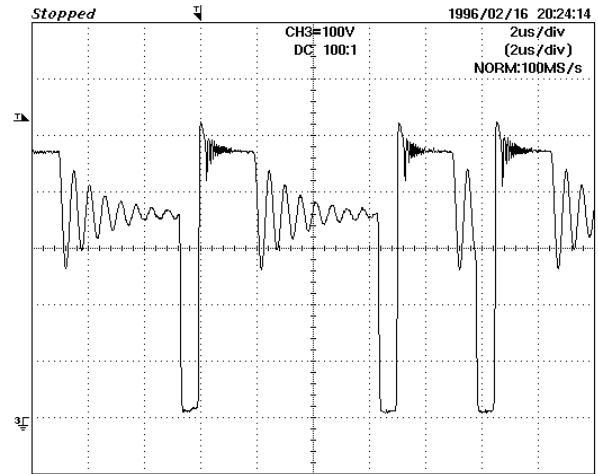

Figure 29 – Peak Drain Voltage During 300 VAC Line Swell, 100 V, 2 μ s/div.



12 Output Ripple Measurements

12.1.1 Ripple Measurement Technique

For DC output ripple measurements, a modified oscilloscope test probe must be used to reduce spurious signals due to pickup. Details of the probe modification are provided in Figure 30 and Figure 31.

The Probe Master 5125BA probe adapter is affixed with two capacitors tied in parallel across the probe tip. The capacitors include one (1) 0.1 $\mu\text{F}/50\text{ V}$ ceramic type and one (1) 1.0 $\mu\text{F}/50\text{ V}$ aluminum electrolytic. ***The aluminum electrolytic type capacitor is polarized, so proper polarity across DC outputs must be maintained (see below).***

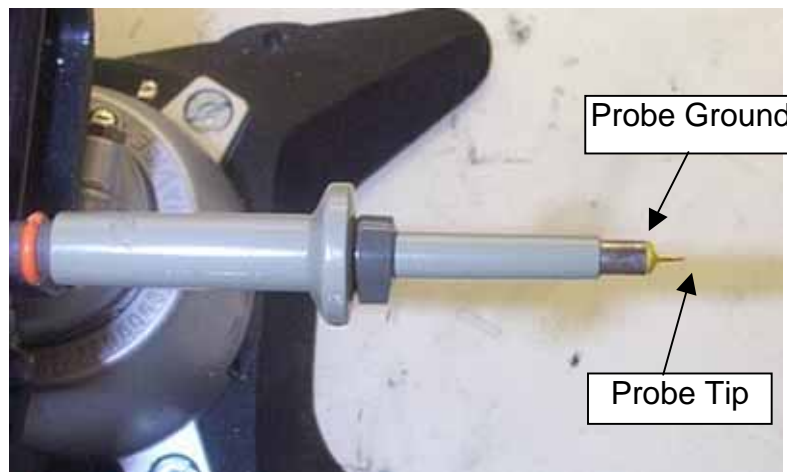
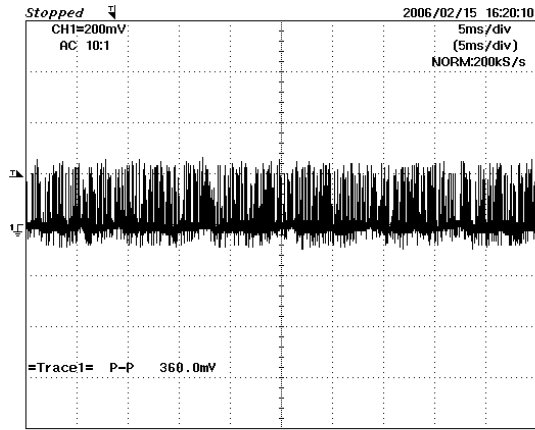

Figure 30 – Oscilloscope Probe Prepared for Ripple Measurement (End Cap and Ground Lead Removed).



Figure 31 – Oscilloscope Probe with Probe Master 5125BA BNC Adapter (Modified with Wires for Probe Ground for Ripple Measurement, and Two Parallel Decoupling Capacitors Added).

12.1.2 Measurement Results



=Filter= =Offset= =Record Length= =Trigger=
Smoothing : OFF CH1 : ----- Main : 10K Mode : AUTO
BW : 20MHz CH2 : 0.0000V Zoom : 10K Type : EDGE CH1 ⌘
Delay : 0.0ns
Hold Off : MINIMUM

Figure 32 – Output Ripple, 90 VAC, 60 Hz, Full Load.
200 mV, 5 ms / div.

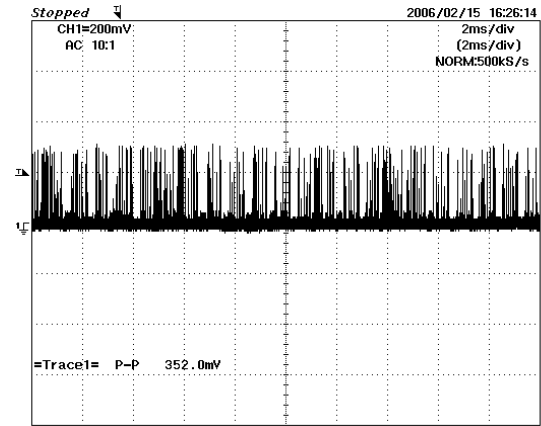

=Filter= =Offset= =Record Length= =Trigger=
Smoothing : OFF CH1 : ----- Main : 10K Mode : AUTO
BW : 20MHz CH2 : 0.0000V Zoom : 10K Type : EDGE CH1 ⌘
Delay : 0.0ns
Hold Off : MINIMUM

Figure 33 – Output Ripple, 265 VAC, 50 Hz, Full Load.
200 mV, 2 ms / div.



13 Output Over-current Shutdown/Restart

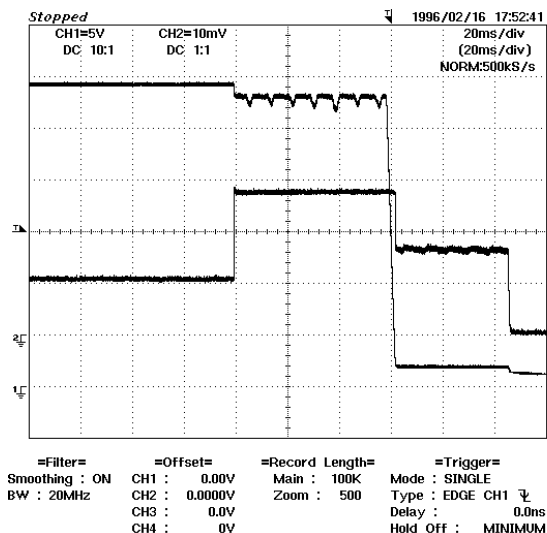

Figure 34 – Supply Shutdown After Output Load Step from 1.07 A to 2.8 A, 85 VAC.
 Top Trace: Output Voltage, 10 V/div.
 Bottom Trace: Output Current, 1 A, 20 ms/div.

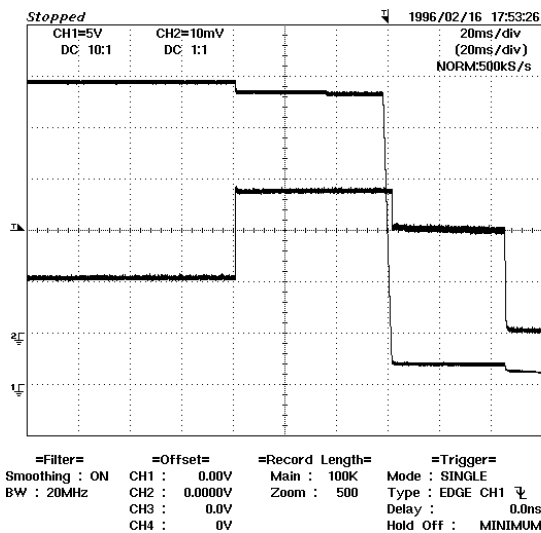

Figure 35 – Supply Shutdown After Output Load Step from 1.07 A to 2.8 A, 265 VAC.
 Top Trace: Output Voltage, 10 V/div.
 Bottom Trace: Output Current, 1 A, 20 ms/div.

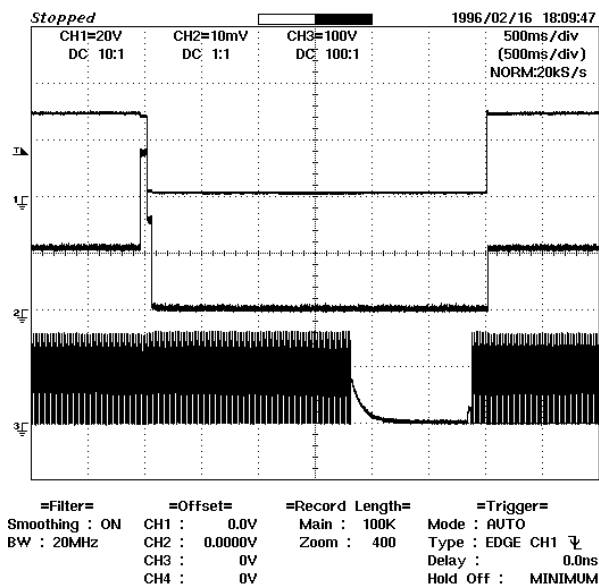

Figure 36 – Output Recovery Following Over-current Shutdown and AC Input Recycle, 115 VAC.
 Top Trace: Output Voltage, 20 V/div.
 Middle Trace: Output Current, 1 A/div.
 Bottom Trace: AC Input Voltage, 100 V, 500 ms/div.



14 Line Surge

Differential input line 1.2/50 μ s surge testing was completed on a single test unit to IEC61000-4-5, with 10 strikes per injection phase at 60 second intervals. Input voltage was set at 230 VAC / 60 Hz. Output was loaded at 32 W and operation was verified following each surge event.

Surge Level (V)	Input Voltage (VAC)	Injection Location	Injection Phase (°)	Test Result (Pass/Fail)
+1kV	230	L to N	0	Pass
-1kV	230	L to N	0	Pass
+1kV	230	L to N	90	Pass
-1kV	230	L to N	90	Pass
+1kV	230	L to N	270	Pass
-1kV	230	L to N	270	Pass
+2kV	230	L, N to GND	0	Pass
+2kV	230	L, N to GND	0	Pass
+2kV	230	L, N to GND	90	Pass
+2kV	230	L, N to GND	90	Pass
+2kV	230	L, N to GND	270	Pass
+2kV	230	L, N to GND	270	Pass

Unit passes under all test conditions.



15 Conducted EMI

For the measurements shown below, the power supply was resistively loaded to 32 W and attached to the LISN via a 2-meter IEC line cord arranged in a serpentine pattern. The power supply secondary return was hard-wired to the LISN ground using a 1-meter cable.

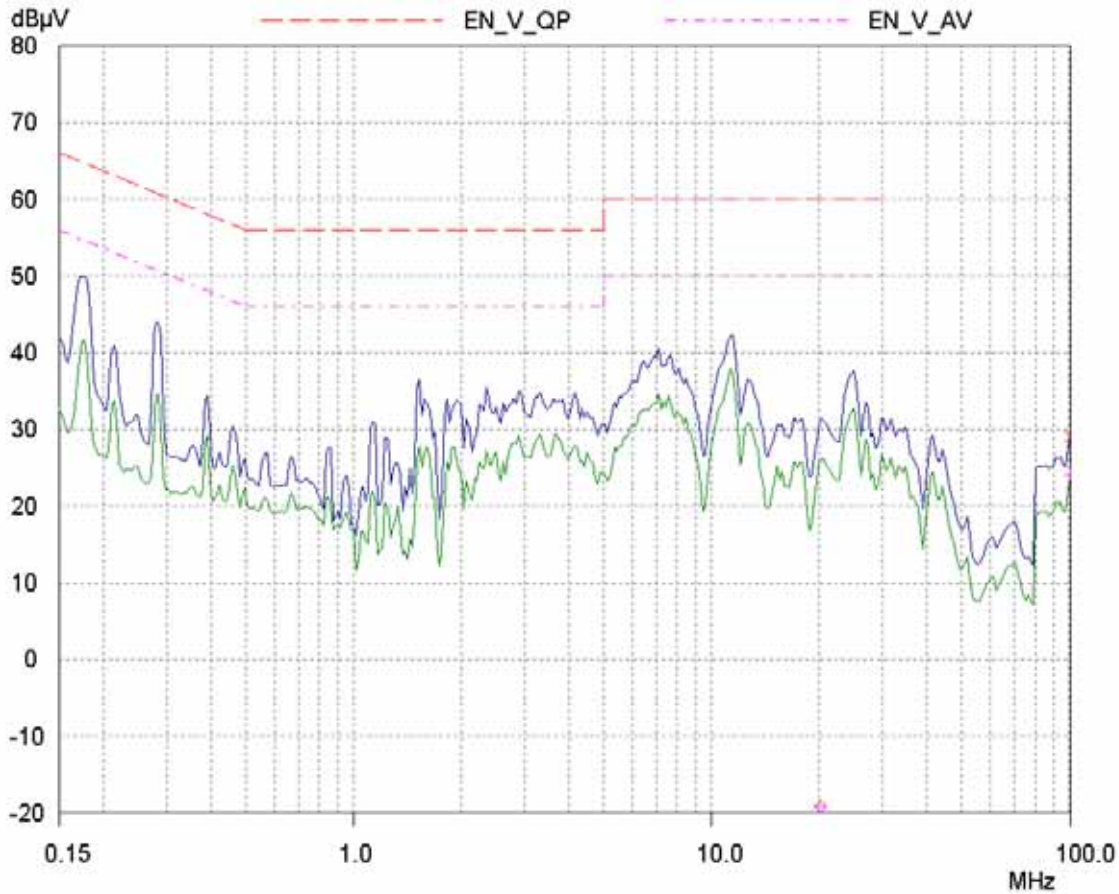

Figure 37 – Conducted EMI, Maximum Steady State Load, 115 VAC, 60 Hz, and EN55022 B Limits.



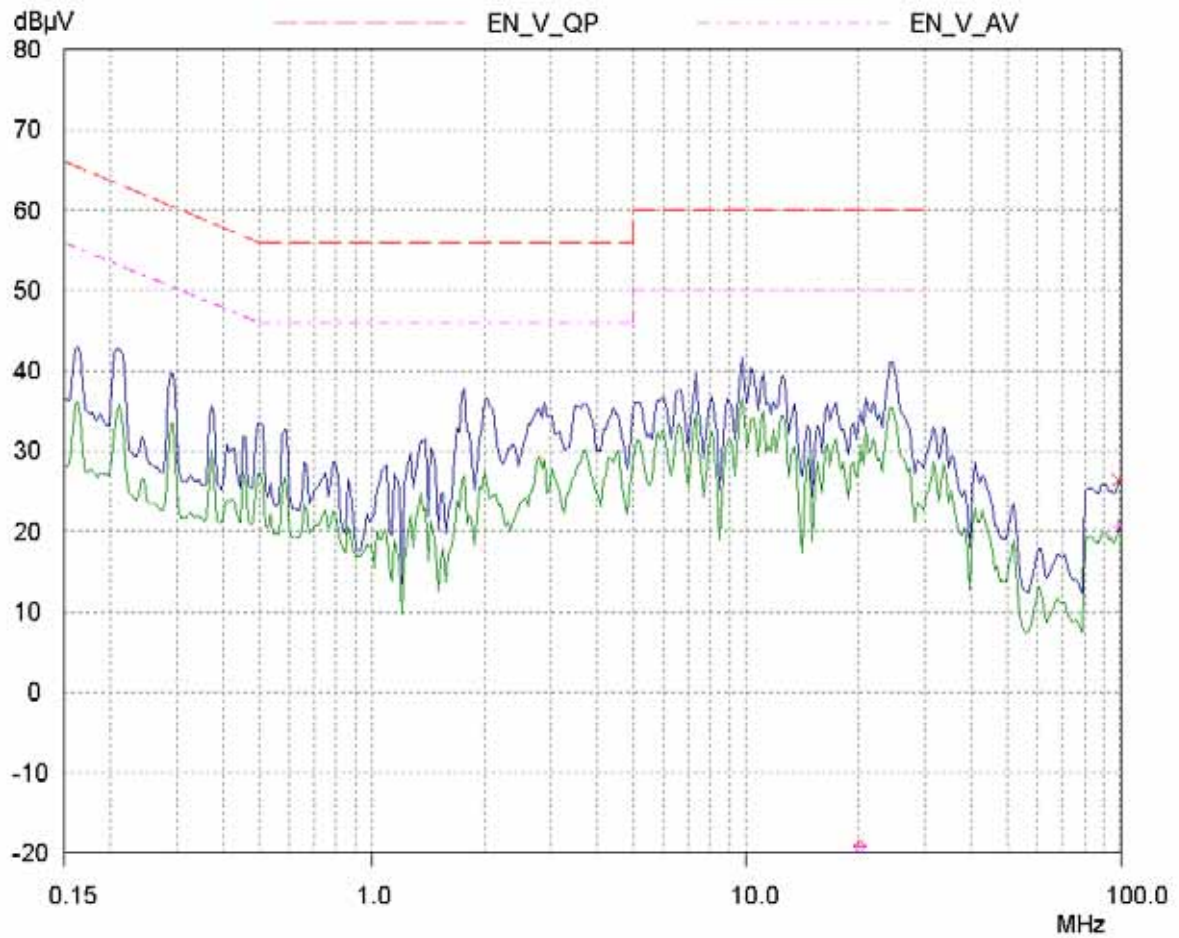
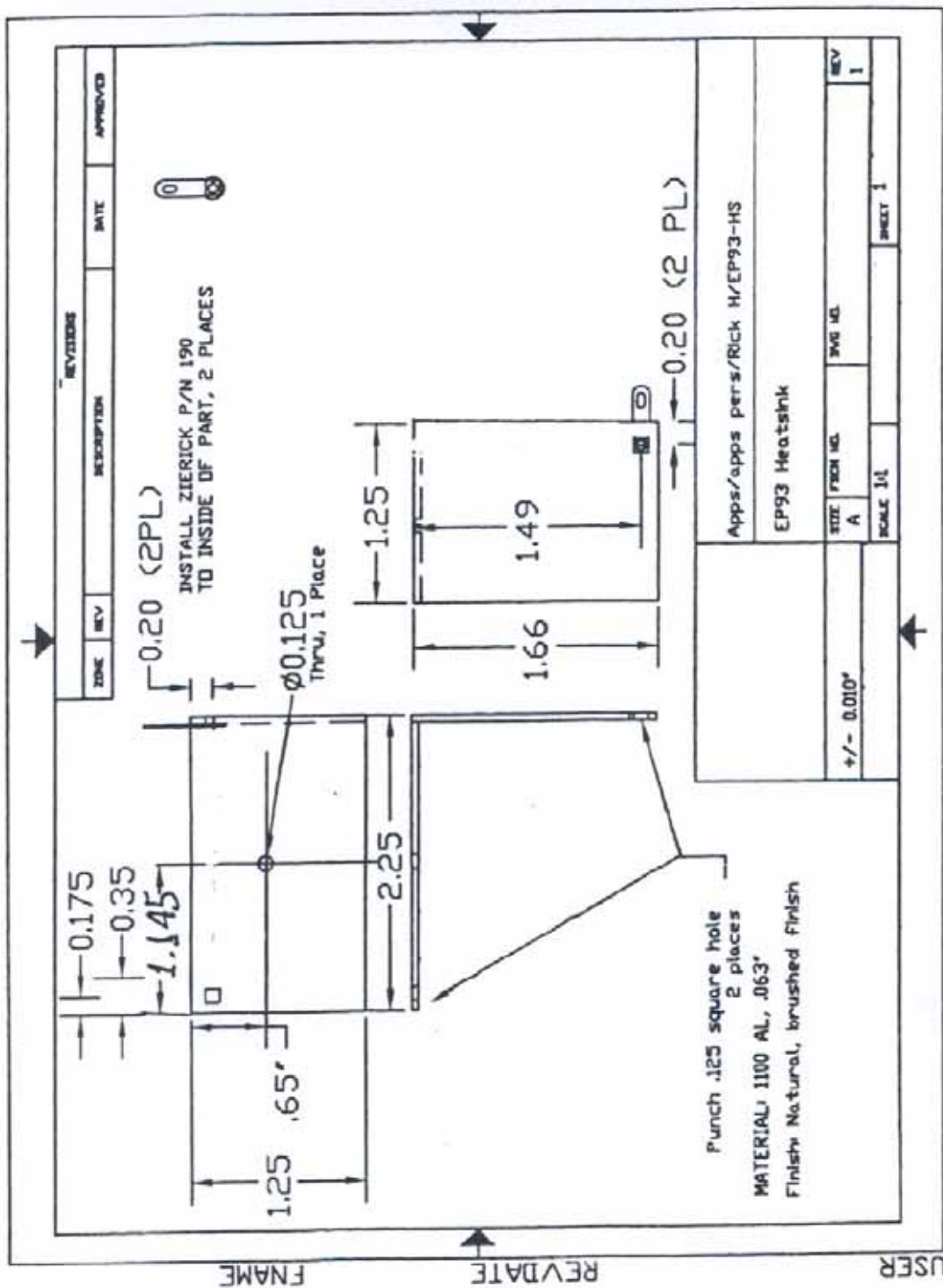

Figure 38 – Conducted EMI, Maximum Steady State Load, 230 VAC, 60 Hz, and EN55022 B Limits.



16 Appendix

16.1 Heat Sink Drawing



17 Revision History

Date	Author	Revision	Description & changes
17-Mar-06	PI SJ	1.0	First Release
24-Mar-06	PI SJ	1.1	Fix board picture and add transformer suppliers
30-Mar-06	PI SJ	1.2	Format for printing
04-May-06	PI SJ	1.3	Updated PeakSwitch symbol in Figure 2
22-Jun-06	PI SJ	1.4	Revised ground connection on the circuit diagram in Figure 2



Notes



Notes



For the latest updates, visit our website: www.powerint.com

Power Integrations reserves the right to make changes to its products at any time to improve reliability or manufacturability. Power Integrations does not assume any liability arising from the use of any device or circuit described herein. POWER INTEGRATIONS MAKES NO WARRANTY HEREIN AND SPECIFICALLY DISCLAIMS ALL WARRANTIES INCLUDING, WITHOUT LIMITATION, THE IMPLIED WARRANTIES OF MERCHANTABILITY, FITNESS FOR A PARTICULAR PURPOSE, AND NON-INFRINGEMENT OF THIRD PARTY RIGHTS.

PATENT INFORMATION

The products and applications illustrated herein (including transformer construction and circuits external to the products) may be covered by one or more U.S. and foreign patents, or potentially by pending U.S. and foreign patent applications assigned to Power Integrations. A complete list of Power Integrations' patents may be found at www.powerint.com. Power Integrations grants its customers a license under certain patent rights as set forth at <http://www.powerint.com/ip.htm>.

The PI Logo, *TOPSwitch*, *TinySwitch*, *LinkSwitch*, *DPA-Switch*, *PeakSwitch*, *EcoSmart*, *Clampless*, *E-Shield*, *Filterfuse*, *PI Expert* and *PI FACTS* are trademarks of Power Integrations, Inc. Other trademarks are property of their respective companies. ©Copyright 2006 Power Integrations, Inc.

Power Integrations Worldwide Sales Support Locations

WORLD HEADQUARTERS

5245 Hellyer Avenue
San Jose, CA 95138, USA.
Main: +1-408-414-9200
Customer Service:
Phone: +1-408-414-9665
Fax: +1-408-414-9765
e-mail: usasales@powerint.com

GERMANY

Rueckertstrasse 3
D-80336, Munich
Germany
Phone: +49-89-5527-3910
Fax: +49-89-5527-3920
e-mail: eurosales@powerint.com

JAPAN

Keihin Tatemono 1st Bldg
2-12-20
Shin-Yokohama, Kohoku-ku,
Yokohama-shi, Kanagawa ken,
Japan 222-0033
Phone: +81-45-471-1021
Fax: +81-45-471-3717
e-mail: japansales@powerint.com

TAIWAN

5F, No. 318, Nei Hu Rd., Sec. 1
Nei Hu Dist.
Taipei, Taiwan 114, R.O.C.
Phone: +886-2-2659-4570
Fax: +886-2-2659-4550
e-mail: taiwansales@powerint.com

CHINA (SHANGHAI)

Rm 807-808A,
Pacheer Commercial Centre,
555 Nanjing Rd. West
Shanghai, P.R.C. 200041
Phone: +86-21-6215-5548
Fax: +86-21-6215-2468
e-mail: chinasales@powerint.com

INDIA

261/A, Ground Floor
7th Main, 17th Cross,
Sadashivanagar
Bangalore, India 560080
Phone: +91-80-5113-8020
Fax: +91-80-5113-8023
e-mail: indiasales@powerint.com

KOREA

RM 602, 6FL
Korea City Air Terminal B/D,
159-6
Samsung-Dong, Kangnam-Gu,
Seoul, 135-728, Korea
Phone: +82-2-2016-6610
Fax: +82-2-2016-6630
e-mail: koreasales@powerint.com

EUROPE HQ

1st Floor, St. James's House
East Street, Farnham
Surrey, GU9 7TJ
United Kingdom
Phone: +44 (0) 1252-730-140
Fax: +44 (0) 1252-727-689
e-mail: eurosales@powerint.com

CHINA (SHENZHEN)

Room 2206-2207, Block A,
Elec. Sci. Tech. Bldg.
2070 Shennan Zhong Rd.
Shenzhen, Guangdong,
China, 518031
Phone: +86-755-8379-3243
Fax: +86-755-8379-5828
e-mail: chinasales@powerint.com

ITALY

Via Vittorio Veneto 12
20091 Bresso MI
Italy
Phone: +39-028-928-6000
Fax: +39-028-928-6009
e-mail: eurosales@powerint.com

SINGAPORE

51 Newton Road,
#15-08/10 Goldhill Plaza,
Singapore, 308900
Phone: +65-6358-2160
Fax: +65-6358-2015
e-mail: singaporesales@powerint.com

APPLICATIONS HOTLINE

World Wide +1-408-414-9660

APPLICATIONS FAX

World Wide +1-408-414-9760



Power Integrations

Tel: +1 408 414 9200 Fax: +1 408 414 9201
www.powerint.com