

**OBSOLETE PRODUCT
NO RECOMMENDED REPLACEMENT**
contact our Technical Support Center at
1-888-INTERSIL or www.intersil.com/tsc

Triple 130MHz Current Feedback Amplifier



The EL2360 is a triple current-feedback operational amplifier which achieves a -3dB bandwidth of 130MHz

at a gain of +2. Built using the Elantec proprietary monolithic complementary bipolar process, these amplifiers use current mode feedback to achieve more bandwidth at a given gain than a conventional voltage feedback amplifier.

The EL2360 is designed to drive a double terminated 75Ω coax cable to video levels. It's fast slew rate of 1500V/μs, combined with the triple amplifier topology, makes its ideal for RGB video applications.

This amplifier can operate on any supply voltage from 4V (±2V) to 33V (±16.5V), yet consume only 8mA per amplifier at any supply voltage. The EL2360 is available in 16-pin PDIP and SOIC packages.

For Single, Dual, or Quad applications, consider the EL2160, EL2260, or EL2460 all in industry standard pin outs. For Single applications with a power down feature, consider the EL2166.

Pinout

**EL2360
(16-PIN SO, PDIP)
TOP VIEW**

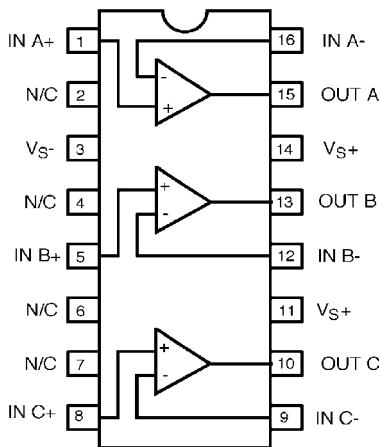

Features

- Triple amplifier topology
- 130MHz -3dB bandwidth ($A_V=+2$)
- 180MHz -3dB bandwidth ($A_V=+1$)
- Wide supply range, ±2V to ±15V
- 80mA output current (peak)
- Low cost
- 1500V/μs slew rate
- Input common mode range to within 1.5V of supplies
- 35ns settling time to 0.1%
- Available in single (EL2160), dual (EL2260), and quad (EL2460) form

Applications

- RGB amplifiers
- Video amplifiers
- Cable driver
- Test equipment amplifiers
- Current to voltage converters
- Video broadcast equipment

Ordering Information

PART NUMBER	TEMP. RANGE	PACKAGE	PKG. NO.
EL2360CN	-40°C to +85°C	16-Pin PDIP	MDP0031
EL2360CS	-40°C to +85°C	16-Pin SOIC	MDP0027

Absolute Maximum Ratings ($T_A = 25^\circ\text{C}$)

Voltage between V_{S+} and V_{S-}	+33V	Output Current (continuous)	$\pm 50\text{mA}$
Common-Mode Input Voltage	V_{S-} to V_{S+}	Operating Ambient Temperature Range	-40°C to $+85^\circ\text{C}$
Differential Input Voltage	$\pm 6\text{V}$	Operating Junction Temperature	150°C
Current into +IN or -IN	$\pm 10\text{mA}$	Storage Temperature Range	-65°C to $+150^\circ\text{C}$
Internal Power Dissipation	See Curves		

CAUTION: Stresses above those listed in "Absolute Maximum Ratings" may cause permanent damage to the device. This is a stress only rating and operation of the device at these or any other conditions above those indicated in the operational sections of this specification is not implied.

IMPORTANT NOTE: All parameters having Min/Max specifications are guaranteed. Typical values are for information purposes only. Unless otherwise noted, all tests are at the specified temperature and are pulsed tests, therefore: $T_J = T_C = T_A$

DC Electrical Specifications $V_S = \pm 15\text{V}$, $R_L = 150\Omega$, $T_A = 25^\circ\text{C}$ unless otherwise specified.

PARAMETER	DESCRIPTION	CONDITIONS	MIN	TYP	MAX	UNITS
V_{OS}	Input Offset Voltage	$V_S = \pm 5\text{V}$, $\pm 15\text{V}$		2	10	mV
TCV_{OS}	Average Input Offset Voltage Drift (Note 1)			10		$\mu\text{V}/^\circ\text{C}$
$+I_{IN}$	+Input Current	$V_S = \pm 5\text{V}$, $\pm 15\text{V}$		0.5	3	μA
$-I_{IN}$	-Input Current	$V_S = \pm 5\text{V}$, $\pm 15\text{V}$		5	25	μA
CMRR	Common Mode Rejection Ratio (Note 2)	$V_S = \pm 5\text{V}$, $\pm 15\text{V}$	50	55		dB
-ICMR	-Input Current Common Mode Rejection (Note 2)	$V_S = \pm 5\text{V}$, $\pm 15\text{V}$		0.2	5	$\mu\text{A}/\text{V}$
PSRR	Power Supply Rejection Ratio (Note 3)		75	95		dB
-IPSR	-Input Current Power Supply Rejection (Note 3)			0.2	5	$\mu\text{A}/\text{V}$
R_{OL}	Transimpedance (Note 4)	$V_S = \pm 15\text{V}$, $R_L = 400\Omega$	500	2000		$\text{k}\Omega$
		$V_S = \pm 15\text{V}$, $R_L = 150\Omega$	500	1800		$\text{k}\Omega$
$+R_{IN}$	+ Input Resistance		1.5	3		$\text{M}\Omega$
$+C_{IN}$	+ Input Capacitance	PDIP package		1.5		pF
		SOIC package		1		pF
CMIR	Common Mode Input Range	$V_S = \pm 15\text{V}$		± 13.5		V
		$V_S = \pm 5\text{V}$		± 3.5		V
V_O	Output Voltage Swing	$V_S = \pm 15\text{V}$, $R_L = 400\Omega$	± 12	± 13.5		V
		$V_S = \pm 15\text{V}$, $R_L = 150\Omega$		± 12		V
		$V_S = \pm 5\text{V}$, $R_L = 150\Omega$	± 3.0	± 3.7		V
I_{SC}	Output Short Circuit Current (Note 5)	$V_S = \pm 5\text{V}$, $\pm 15\text{V}$	60	100	150	mA
I_S	Supply Current (per amplifier)	$V_S = \pm 15\text{V}$		8.0	11.3	mA
		$V_S = \pm 5\text{V}$		5.7	8.8	mA

NOTES:

1. Measured from T_{MIN} to T_{MAX} .
2. $V_{CM} = \pm 10\text{V}$ for $V_S = \pm 15\text{V}$, $V_{CM} = \pm 3\text{V}$ for $V_S = \pm 5\text{V}$.
3. The supplies are moved from $\pm 2.5\text{V}$ to $\pm 15\text{V}$.
4. $V_{OUT} = \pm 7\text{V}$ for $V_S = \pm 15\text{V}$, $V_{OUT} = \pm 2\text{V}$ for $V_S = \pm 5\text{V}$.
5. A heat sink is required to keep junction temperature below absolute maximum when an output is shorted.

EL2360

AC Electrical Specifications $V_S = \pm 15V$, $A_V = +2$, $R_F=R_G=560\Omega$, $R_L=150\Omega$, $T_A=25^\circ C$ unless otherwise specified. (Note 1)

PARAMETER	DESCRIPTION	CONDITIONS	MIN	TYP	MAX	UNITS
BW	-3dB Bandwidth	$V_S = \pm 15V$, $A_V = +2$		130		MHz
		$V_S = \pm 15V$, $A_V = +1$		180		MHz
		$V_S = \pm 5V$, $A_V = +2$		100		MHz
		$V_S = \pm 5V$, $A_V = +1$		110		MHz
SR	Slew Rate (Note 2)	$R_L = 400\Omega$	1000	1500		V/ μ s
		$R_F = 1\text{ k}\Omega$, $R_G = 110\Omega$, $R_L = 400\Omega$		1500		V/ μ s
t_R , t_F	Rise Time, Fall Time	$V_{OUT} = \pm 500mV$		2.7		ns
t_{PD}	Propagation Delay	$V_{OUT} = \pm 500mV$		3.2		ns
OS	Overshoot	$V_{OUT} = \pm 500mV$		0		%
t_S	0.1% Settling Time	$V_{OUT} = \pm 2.5V$, $A_V = -1$		35		ns
dG	Differential Gain (Note 3)	$R_L = 150\Omega$		0.025		%
		$R_L = 500\Omega$		0.006		%
dP	Differential Phase (Note 3)	$R_L = 150\Omega$		0.1		$^\circ$
		$R_L = 500\Omega$		0.005		$^\circ$

NOTES:

1. All AC tests are performed on a "warmed up" part, except Slew Rate, which is pulse tested.
2. Slew Rate is with V_{OUT} from +10V to -10V and measured at +5V and -5V.
3. DC offset from -0.714V to +0.714V, AC amplitude 286mV_{P-P}, f = 3.58MHz.

Typical Performance Curves

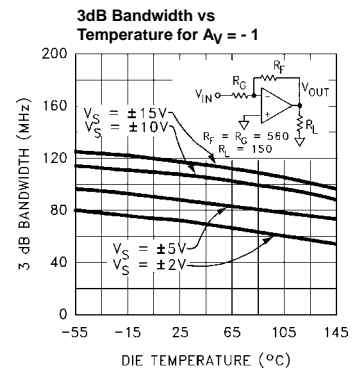
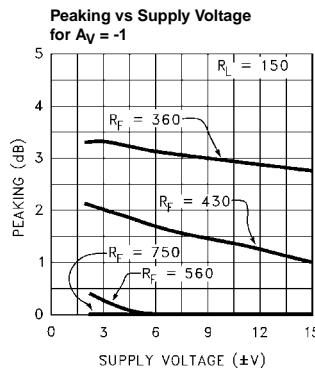
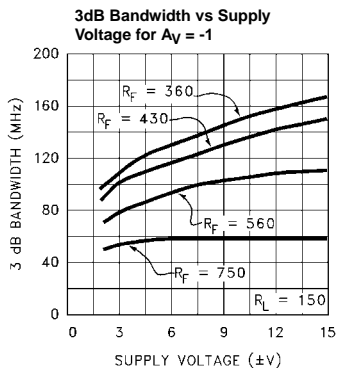
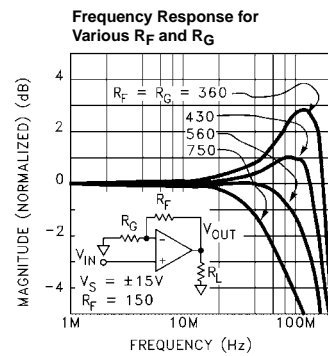
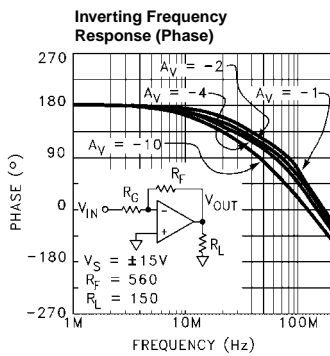
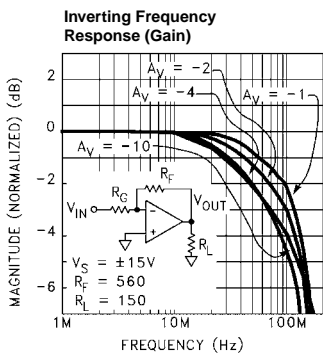
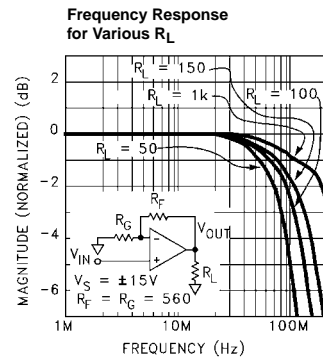
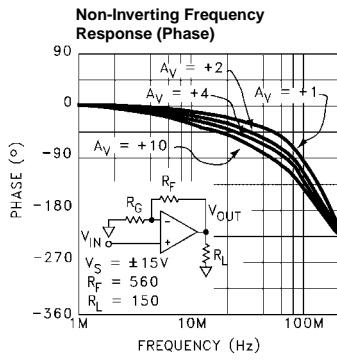
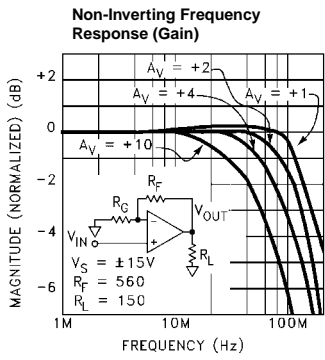

Typical Performance Curves (Continued)

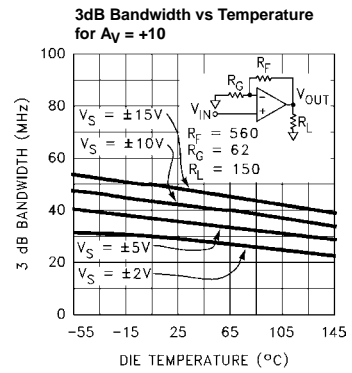
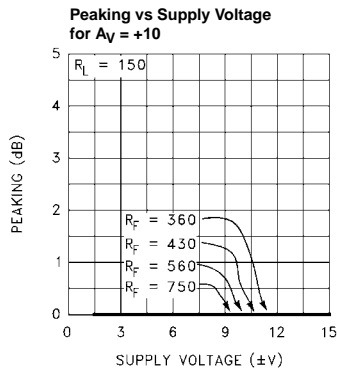
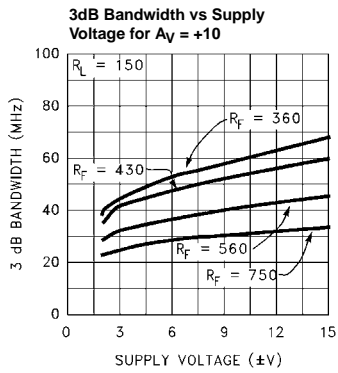
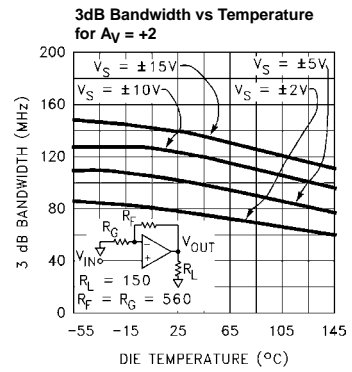
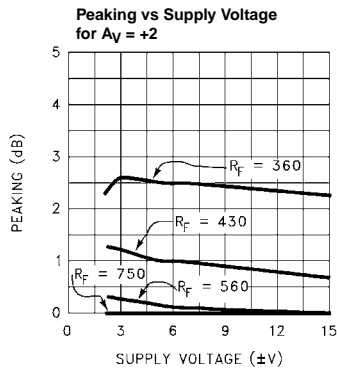
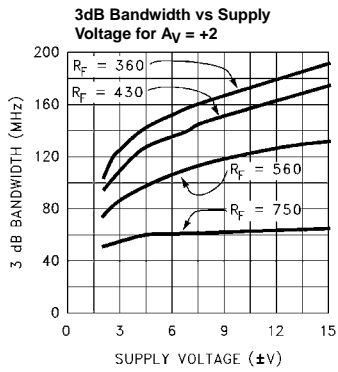
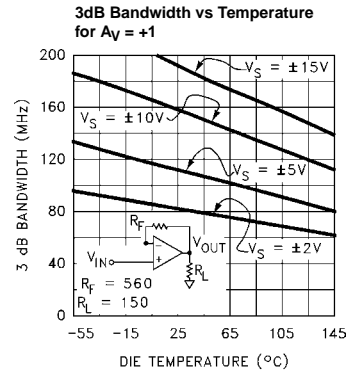
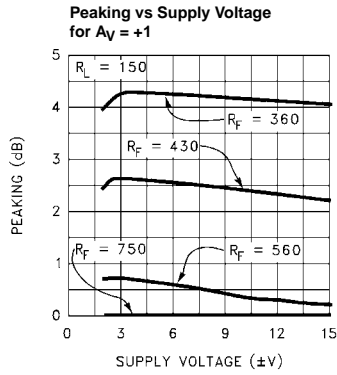
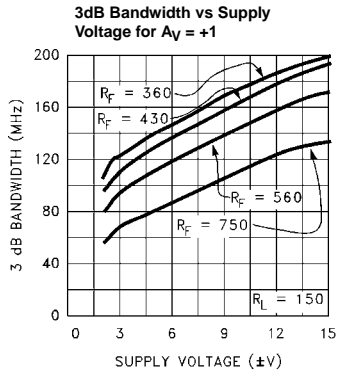

Typical Performance Curves (Continued)

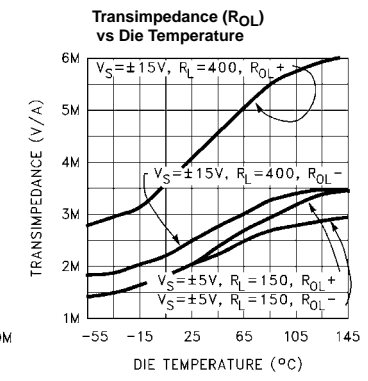
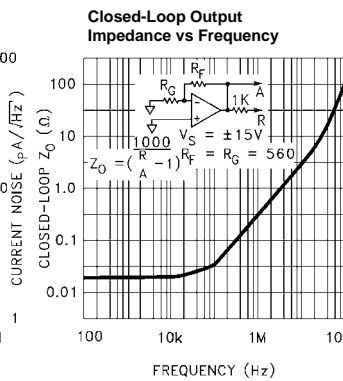
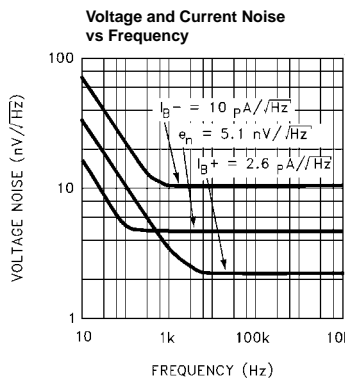
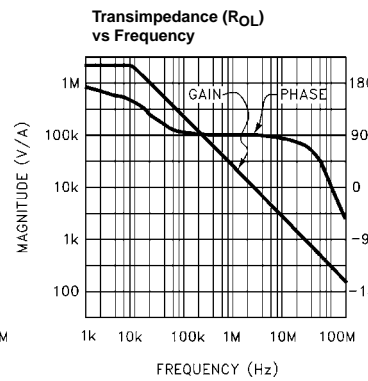
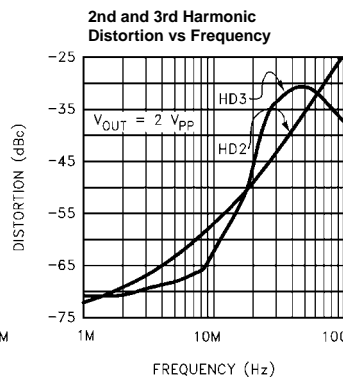
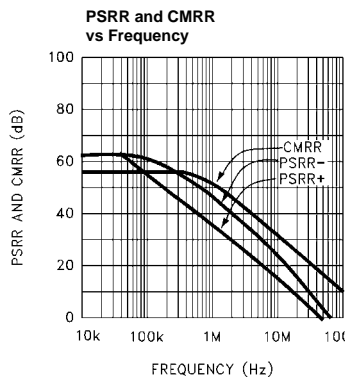
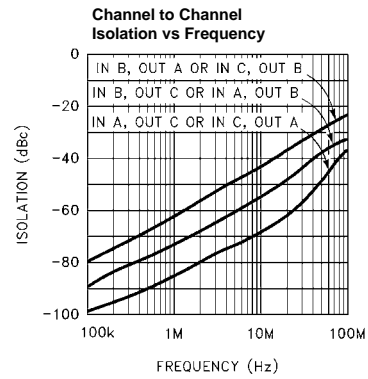
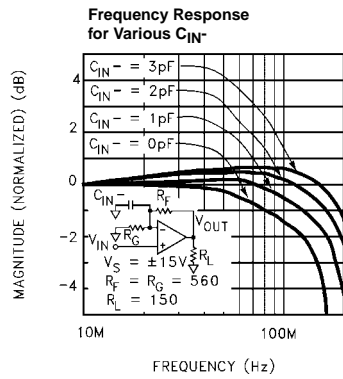
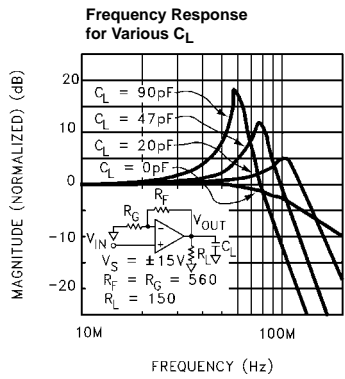

Typical Performance Curves (Continued)

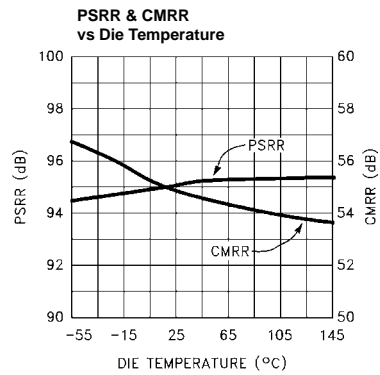
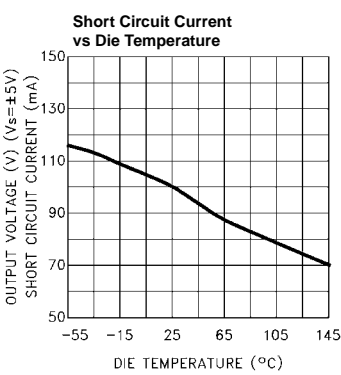
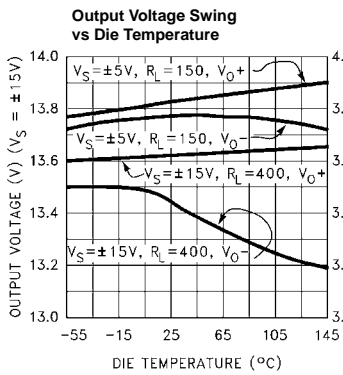
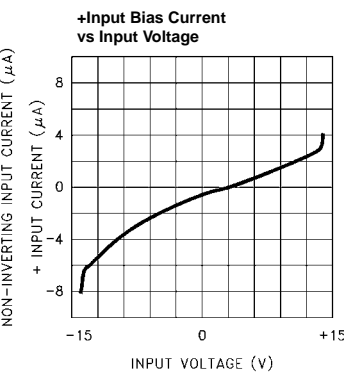
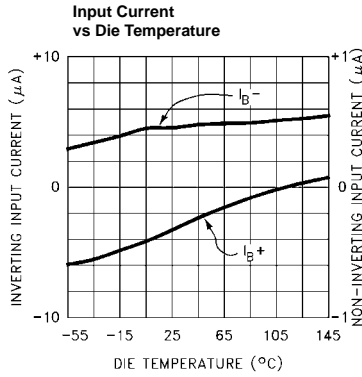
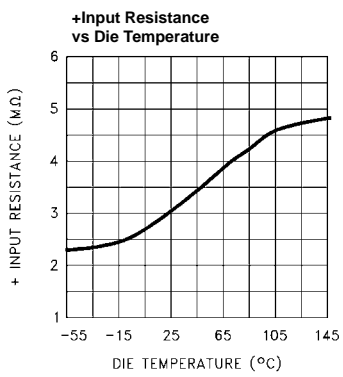
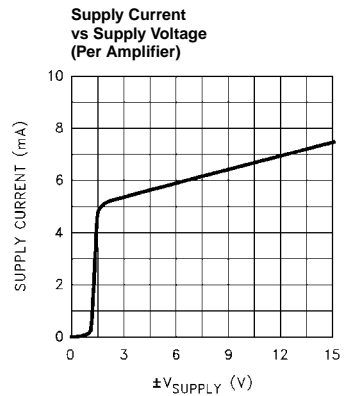
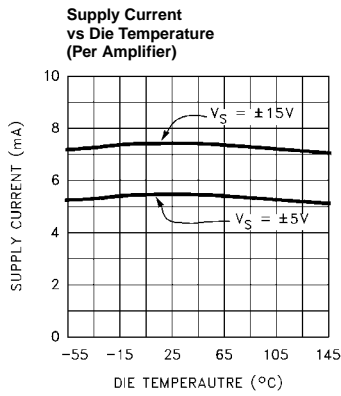
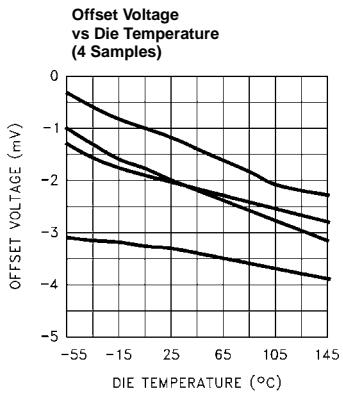

Typical Performance Curves (Continued)

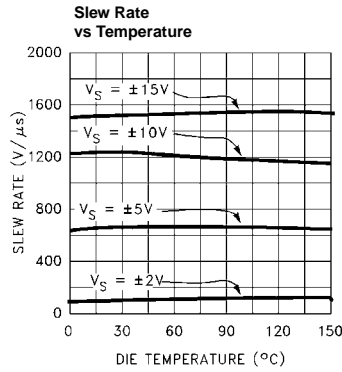
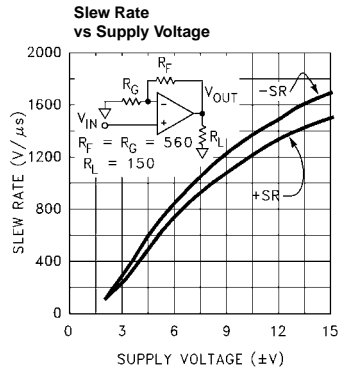
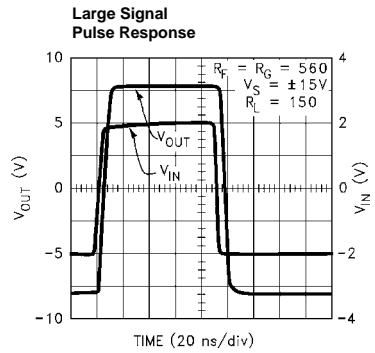
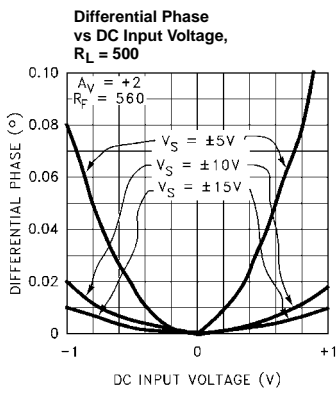
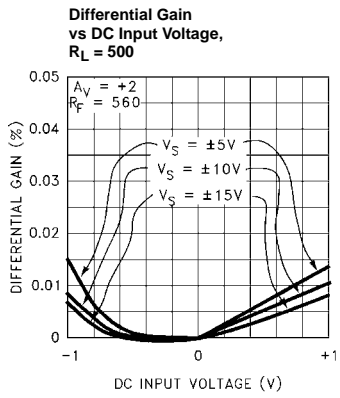
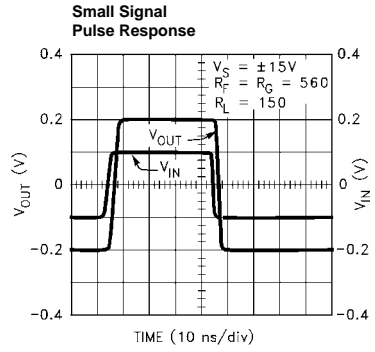
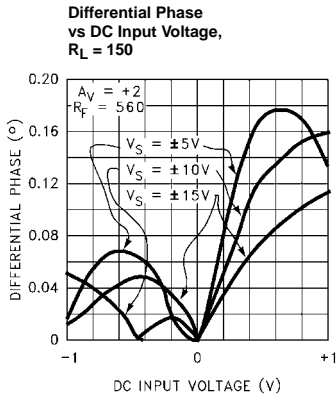
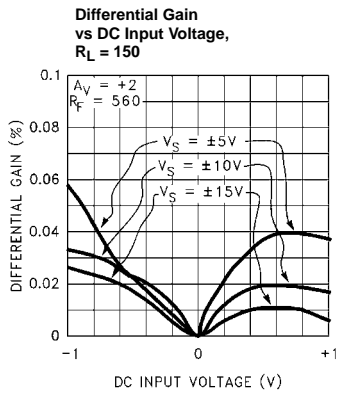

Typical Performance Curves (Continued)

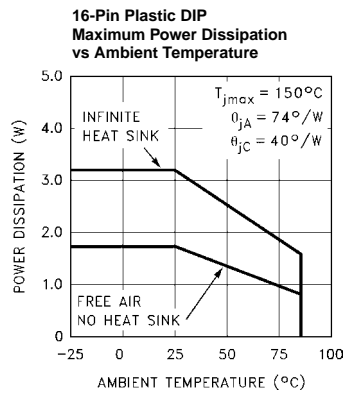
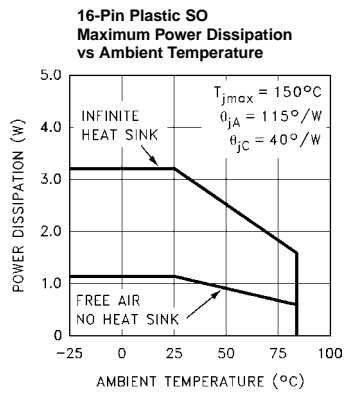
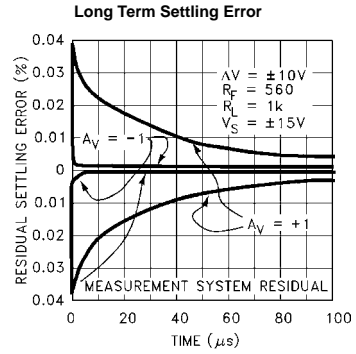
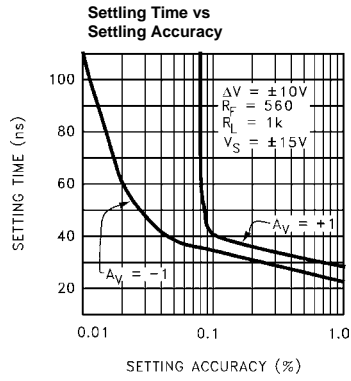

Differential Gain And Phase Test Circuit

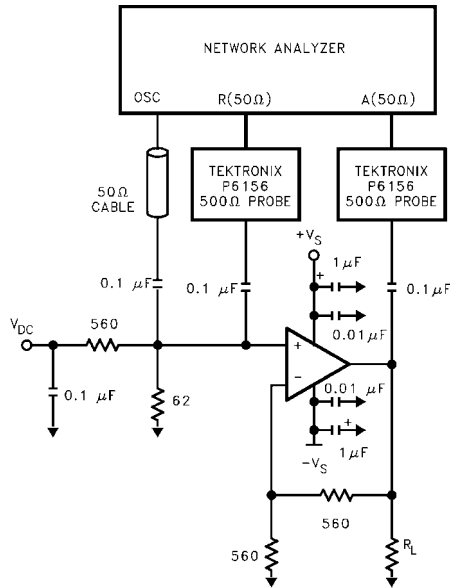

Simplified Schematic (One Amplifier)

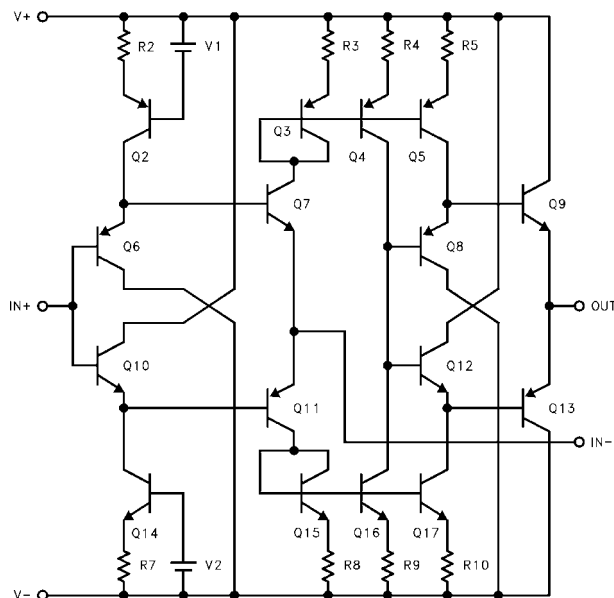

Applications Information

Product Description

The EL2360 is a triple current feedback amplifier that offers wide bandwidth and good video specifications at moderately low supply currents. It is built using Elantec's proprietary complimentary bipolar process and is offered in both a 16-pin PDIP and SOIC packages. Due to the current feedback architecture, the EL2360 closed-loop -3dB bandwidth is dependent on the value of the feedback resistor. First the desired bandwidth is selected by choosing the feedback resistor, R_F , and then the gain is set by picking a gain resistor, R_G . The curves at the beginning of the Typical Performance Curves section show the effect of varying both R_F and R_G . The -3dB bandwidth is somewhat dependent on the power supply voltage. As the supply voltage is decreased, internal junction capacitances increase, causing a reduction in the closed loop bandwidth. To compensate for this, smaller values of feedback resistor can be used at lower supply voltages.

Power Supply Bypassing and Printed Circuit Board Layout

As with any high-frequency device, good printed circuit board layout is necessary for optimum performance. Ground plane construction is highly recommended. Lead lengths should be as short as possible, preferably below 1/4". The power supply pins must be well bypassed to reduce the risk of oscillation. The combination of a 1.0 μ F tantalum capacitor in parallel with a 0.01 μ F ceramic capacitor has been shown to work well when placed at each supply pin.

For good AC performance, parasitic capacitance should be kept to a minimum especially at the inverting input (see the Capacitance at the Inverting Input section). This implies

keeping the ground plane away from this pin. Carbon or Metal-Film resistors are acceptable with the Metal-Film resistors giving slightly less peaking and bandwidth because of their additional series inductance. Use of sockets, particularly for the SO package should be avoided if possible. Sockets add parasitic inductance and capacitance which will result in some additional peaking and overshoot.

Capacitance at the Inverting Input

Any manufacturer's high-speed voltage- or current-feedback amplifier can be affected by stray capacitance at the inverting input. The characteristic curve of gain vs. frequency with variations in C_{IN-} emphasizes this effect. The curve illustrates how the bandwidth can be extended to beyond 200MHz with some additional peaking with an additional 2pF of capacitance at the V_{IN-} pin. For inverting gains, this parasitic capacitance has little effect because the inverting input is a virtual ground, but for non-inverting gains, this capacitance (in conjunction with the feedback and gain resistors) creates a pole in the feedback path of the amplifier. This pole, if low enough in frequency, has the same destabilizing effect as a zero in the forward open-loop response. The use of large value feedback and gain resistors further exacerbates the problem by further lowering the pole frequency.

Feedback Resistor Values

The EL2360 has been designed and specified at a gain of +2 with $R_F = 560\Omega$. This value of feedback resistor yields relatively flat frequency response with little to no peaking out to 130MHz. Since the EL2360 is a current-feedback amplifier, it is also possible to change the value of R_F to get more bandwidth. As seen in the curve of Frequency Response For Various R_F and R_G , bandwidth and peaking

can be easily modified by varying the value of the feedback resistor. For example, by reducing R_F to 430Ω , bandwidth can be extended to 170MHz with under 1dB of peaking. Further reduction of R_F to 360Ω increases the bandwidth to 195MHz with about 2.5dB of peaking.

Bandwidth vs Temperature

Whereas many amplifier's supply current and consequently -3dB bandwidth drop off at high temperature, the EL2360 was designed to have little supply current variation with temperature. An immediate benefit from this is that the -3dB bandwidth does not drop off drastically with temperature. With $V_S = \pm 15V$ and $A_V = +2$, the bandwidth varies only from 150MHz to 110MHz over the entire die junction temperature range of $-50^\circ C < T < 150^\circ C$.

Supply Voltage Range and Single Supply Operation

The EL2360 has been designed to operate with supply voltages from $\pm 2V$ to $\pm 15V$. Optimum bandwidth, slew rate, and video characteristics are obtained at higher supply voltages. However, at $\pm 2V$ supplies, the -3dB bandwidth at $A_V = +2$ is a respectable 70MHz. The following figure is an oscilloscope plot of the EL2360 at $\pm 2V$ supplies, $A_V = +2$, $R_F = R_G = 560\Omega$, driving a load of 150Ω , showing a clean $\pm 600mV$ signal at the output.

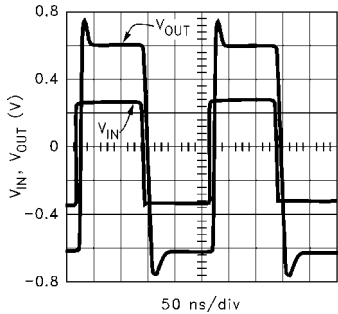

If a single supply is desired, values from +4V to +30V can be used as long as the input common mode range is not exceeded. When using a single supply, be sure to either 1) DC bias the inputs at an appropriate common mode voltage and AC couple the signal, or 2) ensure the driving signal is within the common mode range of the EL2360, which is typically 1.5V from each supply rail.

Settling Characteristics

The EL2360 offers superb settling characteristics to 0.1%, typically in the 35ns to 40ns range. There are no aberrations created from the input stage which often cause longer settling times in other current feedback amplifiers. The EL2360 is not slew rate limited, therefore any size step up to $\pm 10V$ gives approximately the same settling time.

As can be seen from the Long Term Settling Error curve, for $A_V = +1$, there is approximately a 0.035% residual which tails away to 0.01% in about 40 μs . This is a thermal settling error

caused by a power dissipation differential (before and after the voltage step). For $A_V = -1$, due to the inverting mode configuration, this tail does not appear since the input stage does not experience the large voltage change as in the non-inverting mode. With $A_V = -1$, 0.01% settling time is slightly greater than 100ns.

Power Dissipation

The EL2360 amplifier combines both high speed and large output current capability at a moderate supply current in very small packages. It is possible to exceed the maximum junction temperature allowed under certain supply voltage, temperature, and loading conditions. To ensure that the EL2360 remains within it's absolute maximum ratings, the following discussion will help to avoid exceeding the maximum junction temperature.

The maximum power dissipation allowed in a package is determined according to [1]:

$$PD_{MAX} = \frac{T_{JMAX} - T_{AMAX}}{\theta_{JA}}$$

where:

- T_{JMAX} = Maximum Junction Temperature
- T_{AMAX} = Maximum Ambient Temperature
- θ_{JA} = Thermal Resistance of the Package
- PD_{MAX} = Maximum Power Dissipation in the Package

The maximum power dissipation actually produced by an IC is the total quiescent supply current times the total power supply voltage, plus the power in the IC due to the load, or [2]:

$$PD_{MAX} = N \times \left(V_S \times I_{SMAX} + (V_S - V_{OUT}) \times \frac{V_{OUT}}{R_L} \right)$$

where:

- N = Number of amplifiers
- V_S = Total Supply Voltage
- I_{SMAX} = Maximum Supply Current per amplifier
- V_{OUT} = Maximum Output Voltage of the Application
- R_L = Load Resistance tied to Ground

If we set the two PD_{MAX} equations, [1] and [2], equal to each other, and solve for V_S , we can get a family of curves for various loads and output voltages according to [3]:

$$V_S = \frac{\frac{R_L \times (T_{JMAX} - T_{AMAX})}{N \times \theta_{JA}} + (V_{OUT})^2}{(I_S \times R_L) + V_{OUT}}$$

The figures below show total supply voltage V_S vs R_L for various output voltage swings for the PDIP and SOIC packages. The curves assume WORST CASE conditions of $T_A = +85^\circ C$ and $I_S = 11.3mA$ per amplifier. The curves do

not include heat removal or forcing air, or the simple fact that the package will be attached to a circuit board, which can also provide some form of heat removal. Larger temperature and voltage ranges are possible with heat removal and forcing air past the part.

possible to simply increase the value of the feedback resistor (R_F) to reduce the peaking.

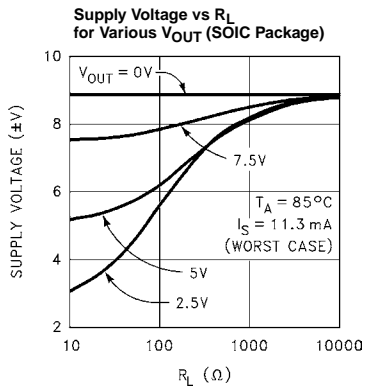
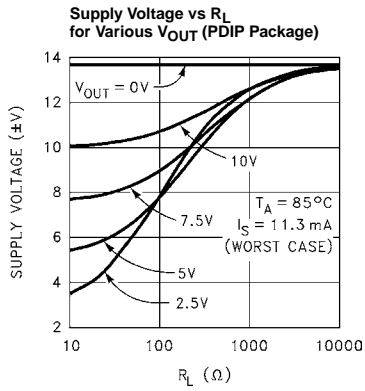

Current Limit

The EL2360 has internal current limits that protect the circuit in the event of an output being shorted to ground. This limit is set at 100mA nominally and reduces with the junction temperature. At $T_J = 150^\circ C$, the current limits at about 65mA. If any one output is shorted to ground, the power dissipation could be well over 1W, and much greater if all outputs are shorted. Heat removal is required in order for the EL2360 to survive an indefinite short.

Driving Cables and Capacitive Loads

When used as a cable driver, double termination is always recommended for reflection-free performance. For those applications, the back-termination series resistor will decouple the EL2360 from the cable and allow extensive capacitive drive. However, other applications may have high capacitive loads without a back-termination resistor. In these applications, a small series resistor (usually between 5Ω and 50Ω) can be placed in series with the output to eliminate most peaking. The gain resistor (R_G) can then be chosen to make up for any gain loss which may be created by this additional resistor at the output. In many cases it is also

```

*
ivos 0 23 2mA
vxx 23 0 0V
e4 24 0 3 0 1.0
e5 25 0 7 0 1.0
e6 26 0 4 0 -1.0
r9 24 23 562
r10 25 23 1K
r11 26 23 1K
*
*Models
*
.model qn npn(is=5e-15 bf=100 tf=0.1ns)
.model qp pnp(is=5e-15 bf=100 tf=0.1ns)
.model dclamp d(is=1e-30 ibv=0.266
+ bv=2.24v n=4)
.ends
    
```

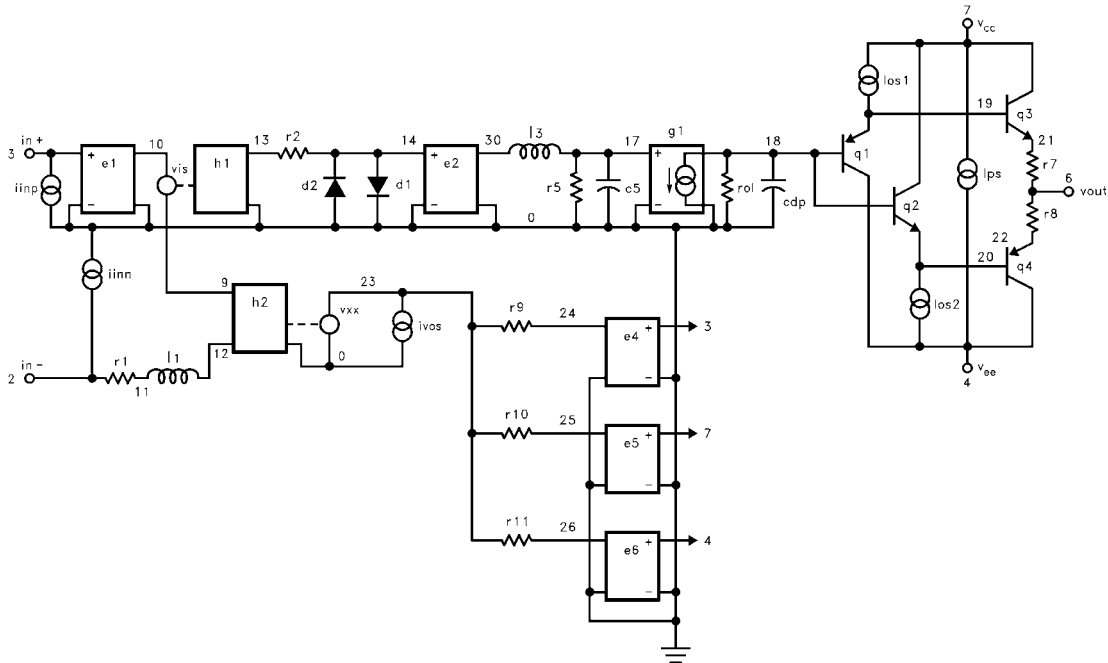

All Intersil U.S. products are manufactured, assembled and tested utilizing ISO9000 quality systems.
 Intersil Corporation's quality certifications can be viewed at www.intersil.com/design/quality

Intersil products are sold by description only. Intersil Corporation reserves the right to make changes in circuit design, software and/or specifications at any time without notice. Accordingly, the reader is cautioned to verify that data sheets are current before placing orders. Information furnished by Intersil is believed to be accurate and reliable. However, no responsibility is assumed by Intersil or its subsidiaries for its use; nor for any infringements of patents or other rights of third parties which may result from its use. No license is granted by implication or otherwise under any patent or patent rights of Intersil or its subsidiaries.

For information regarding Intersil Corporation and its products, see www.intersil.com