

HRS E.FL SERIES

E.FL Coaxial Connectors with World's Smallest Footprint

■ GENERAL

The E.FL Series of surface mount, low-profile, subminiature, coaxial connectors has the world's smallest board occupation area.

In comparison with our S.FL2 Series and H.FL Series, these connectors offer a reduction of approximately 49% to 56% of the board occupation area which permits higher density mounting.

■ FEATURES

- (1) The footprint is 9.4 mm² on the receptacle side which is the world's smallest.
- (2) One type of suitable cable, flexible 0.8-mm outside diameter, ultra-fine teflon cable, has been used with the aim of improving the construction qualities.
External diameter 0.8-mm (single-layer shielded) cable : RF-MF5010 manufactured by Nissei Electric Co., Ltd. CO-6F-SB-CX manufactured by Hitachi Cable Ltd. F12B0074-B manufactured by Junkousha Co., Ltd. 0.4DS-PBA manufactured by Sumitomo Electric Industry Co., Ltd. CXN-3011 manufactured by W.L. Gore, Inc.
- (3) The mated height from the printed board is 3

■ APPLICATIONS

Portable telephones, mobile phones, wireless communication devices, electronic measuring instruments, and GPS, etc.

■ MATERIALS AND PROCESSING

Part Name	Material	Processing
Shell	Phosphor bronze	Gold plating
Insulation	PBT resin (Plug side) Liquid crystal polymer (Receptacle side)	Black Black
Male center connector	Brass	Gold plating
Female center connector	Phosphor bronze	Gold plating

■ PERFORMANCE

Item	Standard Value
Characteristic impedance	50Ω
Insulation resistance	500 MΩ or greater at 100 V DC
Contact resistance	Center 20 mΩ, outside 10 mΩ or less at 10 mA DC
Withstand voltage	200 V AC (rms) for 1 minute
Contact life	50 times
V.S.W.R.	1.3 or less from DC to 2,000 MHz

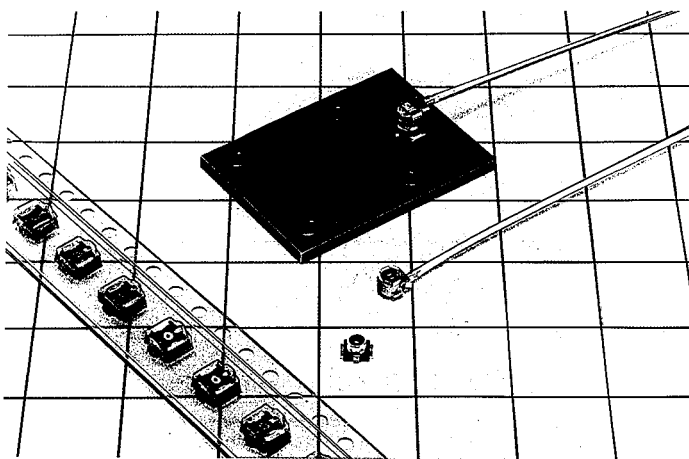

- mm. (3.2 mm, maximum)
- (4) High frequency performance is V.S.W.R. 1.3 or less from D.C., A.C.1 to 2,000 MHz.
- (5) Use of an extraction jig permits easy extraction of the connector.
- (6) Receptacles come with embossed tape packaging to permit automatic mounting.
- (7) Coupling checks are easy. Subminiature size notwithstanding, the tactile lock sensation ensures coupling.

◆ Comparison of Board Spaces Area

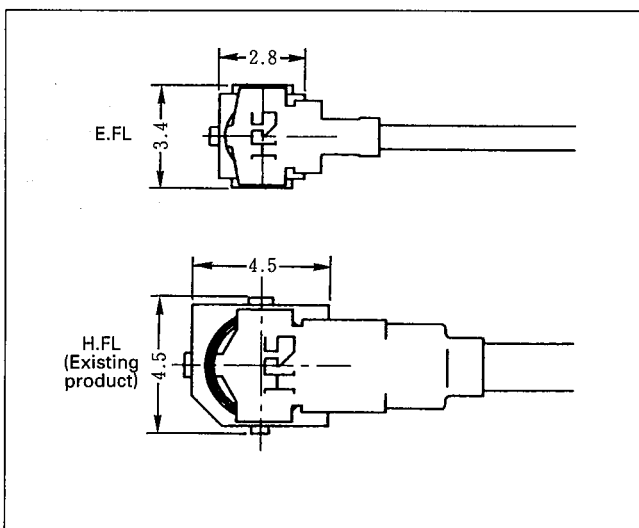

■ PRODUCT INFORMATION

▲ Right-angle plugs

Item	HRS No.	Product No.	Suitable Cable
Right-angle plug shell For Dia. 0.8 cable	CL331-0401-4	E.FL-LP-040	RF-MF5010 manufactured by Nissei Electric Co., Ltd. CO-6F-SB-CX50 manufactured by Hitachi Cable Ltd. F12B0074-B manufactured by Junkousha Co., Ltd.
Right-angle plug shell For Dia. 1.32 cable	CL331-0402-7	E.FL-LP-066	0.4DS-PBA manufactured by Sumitomo Electric Industry Co., Ltd. CXN-3011 manufactured by W.L. Gore, Inc.

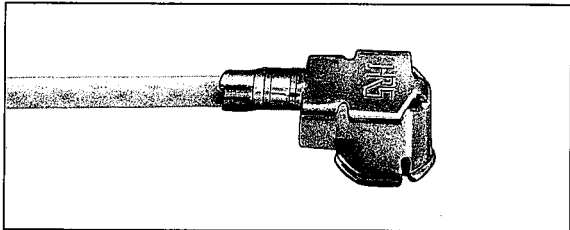
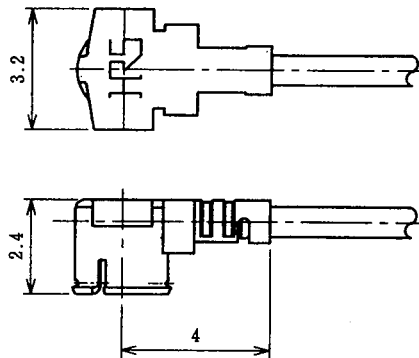

Diagram of the Condition Following Cable Wiring



■ Receptacle

▲ Straight Receptacle

HRS No.	Product No.	Unit of Sale
CL331-0421-1-01	E.FL-R-SMT(01)	Package sales (100 pcs./pkg.)
CL331-0421-1-10	E.FL-R-SMT(10)	Reel sales (2,500 pcs./reel)

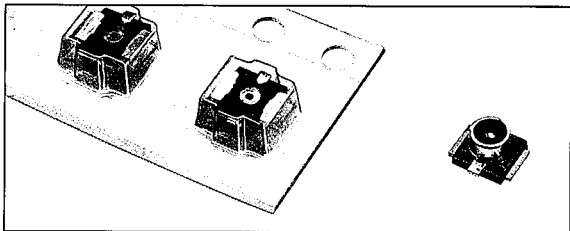
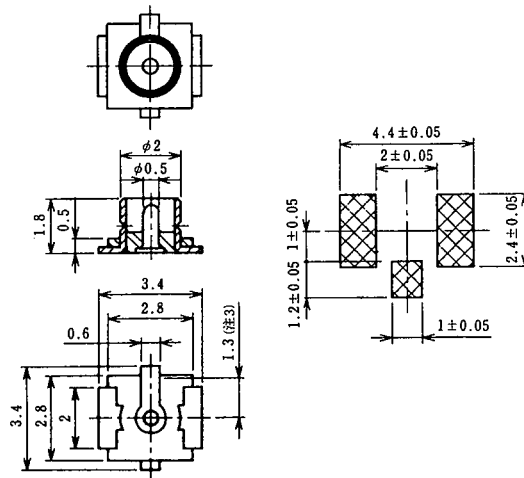

Diagram of Recommended Board Pattern Dimensions



NOTE1 : Unit of sale of E.FL-R-SMT (01) is by the package (100 pieces).

The unit of sale of E.FL-R-SMT (10) is by the reel (2,500 pieces)

NOTE2 : Tolerance values associated with the molded resin at the center contact.

▲ Right-angle Receptacle

HRS No.	Product No.	Unit of Sale
331-0422-4-01	E.FL-LR-SMT(01)	Package sales (100 pcs./pkg.)
331-0422-4-10	E.FL-LR-SMT(10)	Reel sales (2,500 pcs./reel)

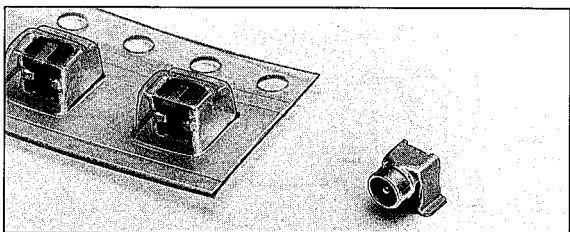
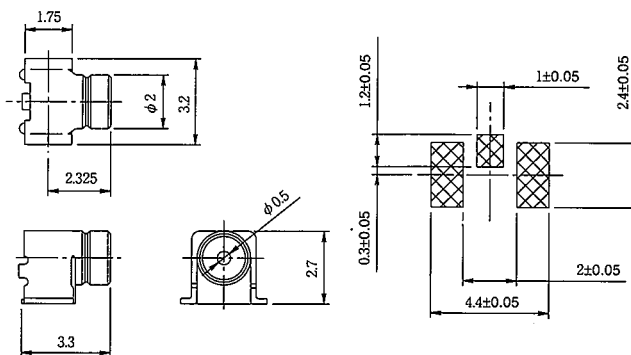

Diagram of Recommended Board Pattern Dimensions



NOTE1 : Unit of sale of E.FL-LR-SMT (01) is by the package (100 pieces).

The unit of sale of E.FL-LR-SMT (10) is by the reel (2,500 pieces).

▲ Conversion Adapters
SMA-Type Plugs — E.FL Jack Conversion Type

HRS No.	Product No.
CL311-0279-8	HRMP-E.FLJ

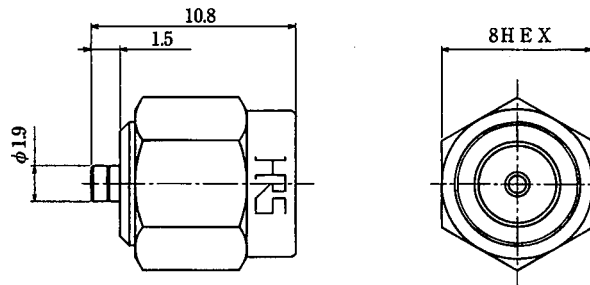
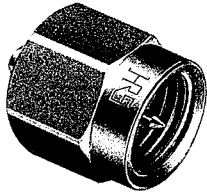

NOTE : The lock mechanism of the engagement portion of the E.FL side is weaker than in the regular product and so this item cannot be used other than for performance measurement uses.

SMA-Type Jacks — E.FL Plug Conversion Type

HRS No.	Product No.
CL311-0278-5	HRMJ-E.FLP

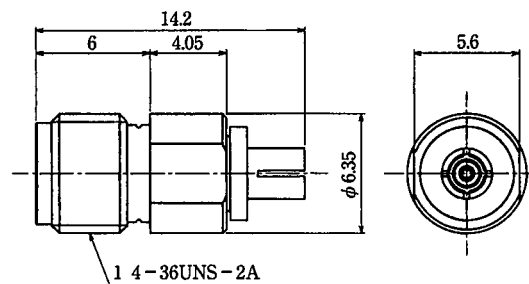
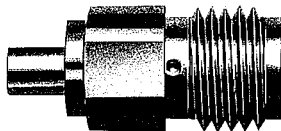

NOTE : The engagement portion of the E.FL side does not have a lock mechanism and so this item cannot be used other than for performance measurement uses.

▲ Accessories

HRS No.	Product No.
CL331-0416-1	E.FL-R-1

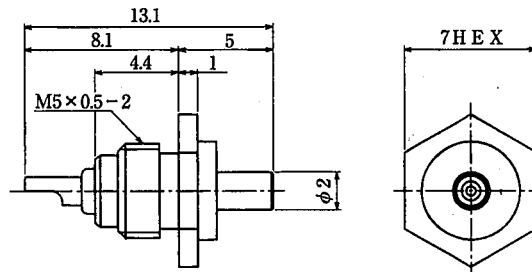
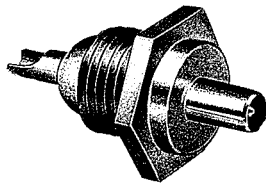

NOTE : This receptacle is used for testing the plug assembly.

HRS No.	Product No.
CL331-0441-9	E.FL-LP-N

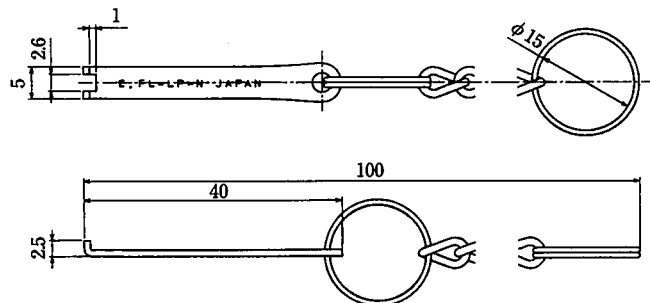
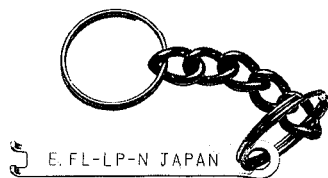

NOTE : The jig is used to unmate the connectors.

■ Embossed Carrier Tape Dimensions

▲ E.FL-R-SMT

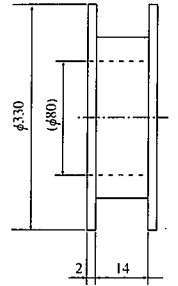
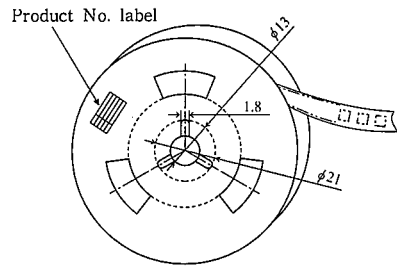
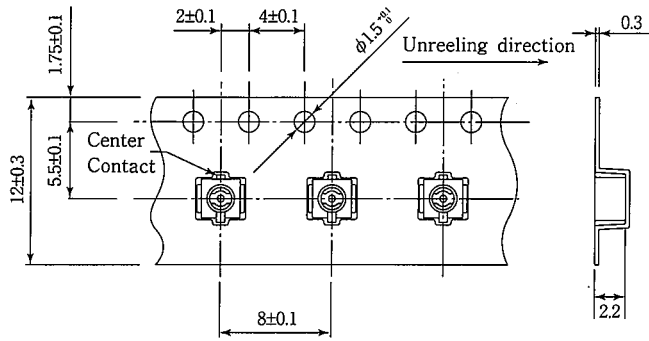

▲ E.FL-LR-SMT

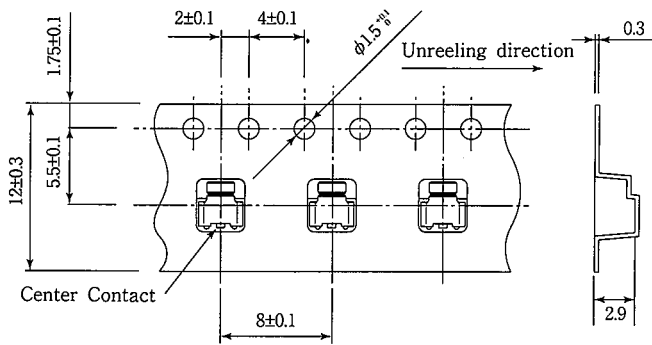

■ Cable Harness Specifications

Dimension specifications of E.FL Series harness products should be made as indicated below.

Connector Single-Ended Harness

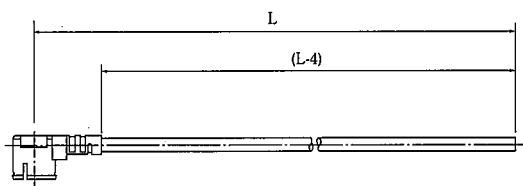

Connector Double-Ended Harness

