



## Design Example Report

<b>Title</b>	<b><i>41W (53Wpk) Power Supply using TOP246Y</i></b>
<b>Specification</b>	Input: 85 – 265 VAC Output: 30V/80mA, 23V/0.5A, 12V/2A, 5V/2A, 3.3V/1.5A
<b>Application</b>	Digital Video Recorder
<b>Author</b>	Power Integrations Applications Department
<b>Document Number</b>	DER-44
<b>Date</b>	March 7, 2005
<b>Revision</b>	1.0

### Summary and Features

- No linear regulators used
- One transformer solution
- Good cross regulation
- No heatsinks used in secondary
- Low cost OVP using TO-92 SCR crowbar
- Low EMI with low-cost EMI filter

The products and applications illustrated herein (including circuits external to the products and transformer construction) may be covered by one or more U.S. and foreign patents or potentially by pending U.S. and foreign patent applications assigned to Power Integrations. A complete list of Power Integrations' patents may be found at [www.powerint.com](http://www.powerint.com).

---

**Table Of Contents**

1	Introduction .....	4
2	Photograph.....	4
3	Power Supply Specification .....	5
4	Schematic .....	6
5	Circuit Description .....	7
5.1	Input EMI Filtering .....	7
5.2	TOPSwitch Primary .....	7
5.3	Outputs.....	7
5.4	Output Feedback.....	7
5.5	Output OV Protection .....	7
6	PCB Layout .....	8
7	Bill Of Materials .....	9
8	Transformer Specification .....	11
8.1	Electrical Diagram .....	11
8.2	Electrical Specifications .....	11
8.3	Materials.....	12
8.4	Transformer Build Diagram .....	12
8.4.1	WD#3 Copper Foil build diagram: .....	13
8.4.2	WDG#4 & #5 Copper Foil build diagram: .....	13
8.5	Transformer Construction.....	14
8.6	Transformer Spreadsheets.....	15
9	Performance Data .....	18
9.1	Line and Load Regulation .....	18
9.2	Efficiency.....	19
9.3	Overvoltage Protection.....	19
10	Thermal Performance .....	20
11	Control Loop Measurements.....	21
11.1	110 VAC Maximum Continuous Load .....	21
11.2	230 VAC Maximum Continuous Load .....	21
12	Waveforms.....	22
12.1	Drain Voltage and Current, Normal Operation .....	22
12.2	Output Voltage Start-up Profile .....	22
12.3	Drain Voltage Start-up Profile.....	23
13	Output Ripple Measurements .....	24
13.1.1	Ripple Measurement Technique .....	24
13.1.2	Measurement Results .....	25
14	Conducted EMI .....	28
14.1	230V High Line EMI .....	28
15	Revision History .....	29



**Important Note:**

Although this board is designed to satisfy safety isolation requirements, the engineering prototype has not been agency approved. Therefore, all testing should be performed using an isolation transformer to provide the AC input to the prototype board.

Design Reports contain a power supply design specification, schematic, bill of materials, and transformer documentation. Performance data and typical operation characteristics are included. Typically only a single prototype has been built.



## 1 Introduction

This document is an engineering report describing a PSU design using TOP246Y. The design adopts a one transformer solution, meets EMI and peak power with good margin. The use of a smaller transformer is made possible by TOPSwitch-GX's high switching frequency with good switching performance, and the low EMI with a low-cost filter is made possible because of TOPSwitch-GX's frequency jitter and E-Shield™ transformer winding techniques.

This document contains the power supply specifications, schematic, Bill of materials, transformer documentation, printed circuit layout, and performance data.

## 2 Photograph

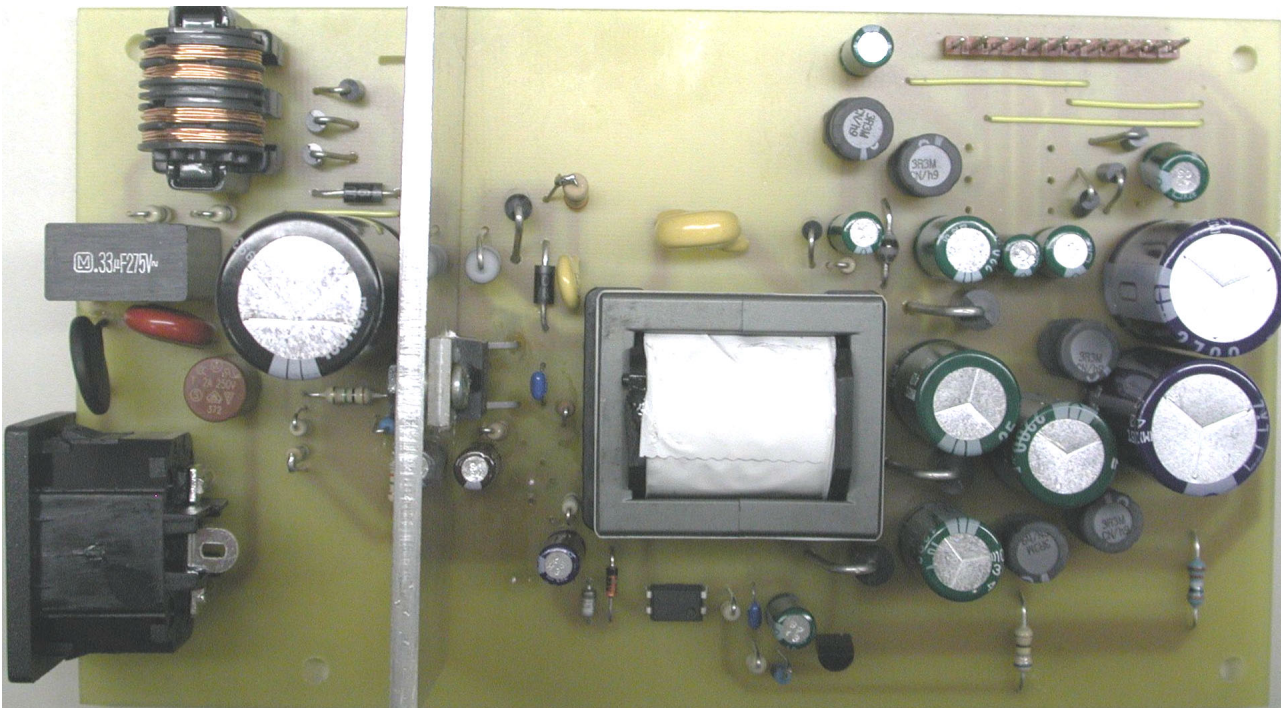


Figure 1 – Circuit Board Photograph.

### 3 Power Supply Specification

Description	Symbol	Min	Typ	Max	Units	Comment
<b>Input</b> Voltage	$V_{IN}$	90		265	VAC	2 Wires System
Frequency	$f_{LINE}$	47	50/60	64	Hz	
Output Voltage 1	$V_{OUT1}$	3.135	3.3	3.465	V	+/- 5% 20 MHz Bandwidth for all the outputs
Output Ripple Voltage 1	$V_{RIPPLE1}$				mV	
Output Current 1	$I_{OUT1}$		1.5		A	
Output Voltage 2	$V_{OUT2}$	4.75	5.0	5.25	V	+/- 5% 20 MHz Bandwidth for all the outputs
Output Ripple Voltage 2	$V_{RIPPLE2}$				mV	
Output Current 2	$I_{OUT2}$		2		A	
Output Voltage 3	$V_{OUT3}$	11.4	12	12.6	V	+/- 5% 20 MHz Bandwidth for all the outputs
Output Ripple Voltage 3	$V_{RIPPLE3}$				mV	
Output Current 3	$I_{OUT3}$		2		A	
Output Voltage 4 (FL)	$V_{OUT4}$	21.85	23	24.15	V	+/- 5% 20 MHz Bandwidth for all the outputs
Output Ripple Voltage 4	$V_{RIPPLE4}$				mV	
Output Current 4	$I_{OUT4}$		0.5		A	
Output Voltage 5	$V_{OUT5}$	28.5	30	31.5	V	+/- 5% 20 MHz Bandwidth for all the outputs
Output Ripple Voltage 5	$V_{RIPPLE5}$				mV	
Output Current 5	$I_{OUT5}$		0.08		A	
<b>Total Output Power</b> Continuous Output Power	$P_{OUT}$		41		W	Actual load measurement
Peak Output Power	$P_{OUT\_PEAK}$		53		W	
<b>Efficiency</b>	$\eta$	72.8			%	Measured at 230VAC, $P_{OUT}$ (41W), 25 °C
<b>Environmental</b> Conducted EMI Safety			Meets CISPR22B / EN55022B Designed to meet IEC950, UL1950 Class II			
Ambient Temperature	$T_{AMB}$		25		°C	Free convection, sea level

The power supply is designed to meet 53W output power for a short period – a few minutes. The output power is only thermally limited by the heatsink attached to the TOP246Y. In the currently sized heatsink (80 x 35 x 3 mm), the continuous output power is 41W.





## 5 Circuit Description

The schematic in Figure 2 shows an off-line flyback converter using the TOP246Y. The circuit is designed for 85 VAC to 265 VAC.

### 5.1 Input EMI Filtering

X-capacitor C32, and common-mode choke L1 act as an input filter to reduce common mode and differential mode EMI. The AC line voltage is rectified and filtered to generate a high voltage DC bus via D1-4 and C1.

### 5.2 TOPSwitch Primary

Diode D5, C6, and R4, R45 and VR5 clamp leakage spikes generated when the MOSFET when U1 switches off. D5 is a glass-passivated normal recovery rectifier. The slow, controlled recovery time of D5 allows energy stored in C6 to be recycled back to the high voltage bus, significantly increasing efficiency. A normal (non-glass-passivated) 1N4007 should not be substituted for the glass-passivated device. C5 bypasses the U1 control pin. C4 has three functions. It provides the energy required by U1 during startup, sets the auto-restart frequency during fault conditions, and also acts to roll off the gain of U1 as a function of frequency. R8 adds a zero to the control loop to help stabilize the power supply control loop. Diode D6 and capacitor C3 provide rectified and filtered bias power for U1 and U2. Components R39, R48 and R9 provide a signal to the U1 X pin to reduce current limit at high line to keep the maximum output power consistent with low line. R47 and R38 provide OV/UV protection.

### 5.3 Outputs

The T1 output is rectified and filtered by Diodes D8-D12 and filtered by inductor/capacitor networks on most outputs. NOTE: Large capacitors were used for the 12V output in order to prevent possible voltage overshoots from the reverse current coming from the Hard Disk Drive motor. Testing with the actual unit may show that these capacitors can be reduced for cost reduction.

### 5.4 Output Feedback

Output feedback is used from a combination of the 5 V and the 3.3 V rails. Resistors R31, R32 and R30 develop a feedback voltage, which is fed to the reference regulator U3. U3 drives optocoupler U2 through resistor R27 to provide feedback information to the U1 control pin. The optocoupler output also provides power to U1 during normal operating conditions. Capacitor C7 applies drive to the optocoupler during supply startup to reduce output voltage overshoot. Capacitor C21 and R29 provide frequency compensation for error amplifier U3.

### 5.5 Output OV Protection

Q2 is positioned across the 30V output winding; upon OV on the 5V, detected by VR10, Q2 will be triggered ON to short the 30V winding. The PS will go into auto-restart mode until the OV fault is removed.



## 6 PCB Layout

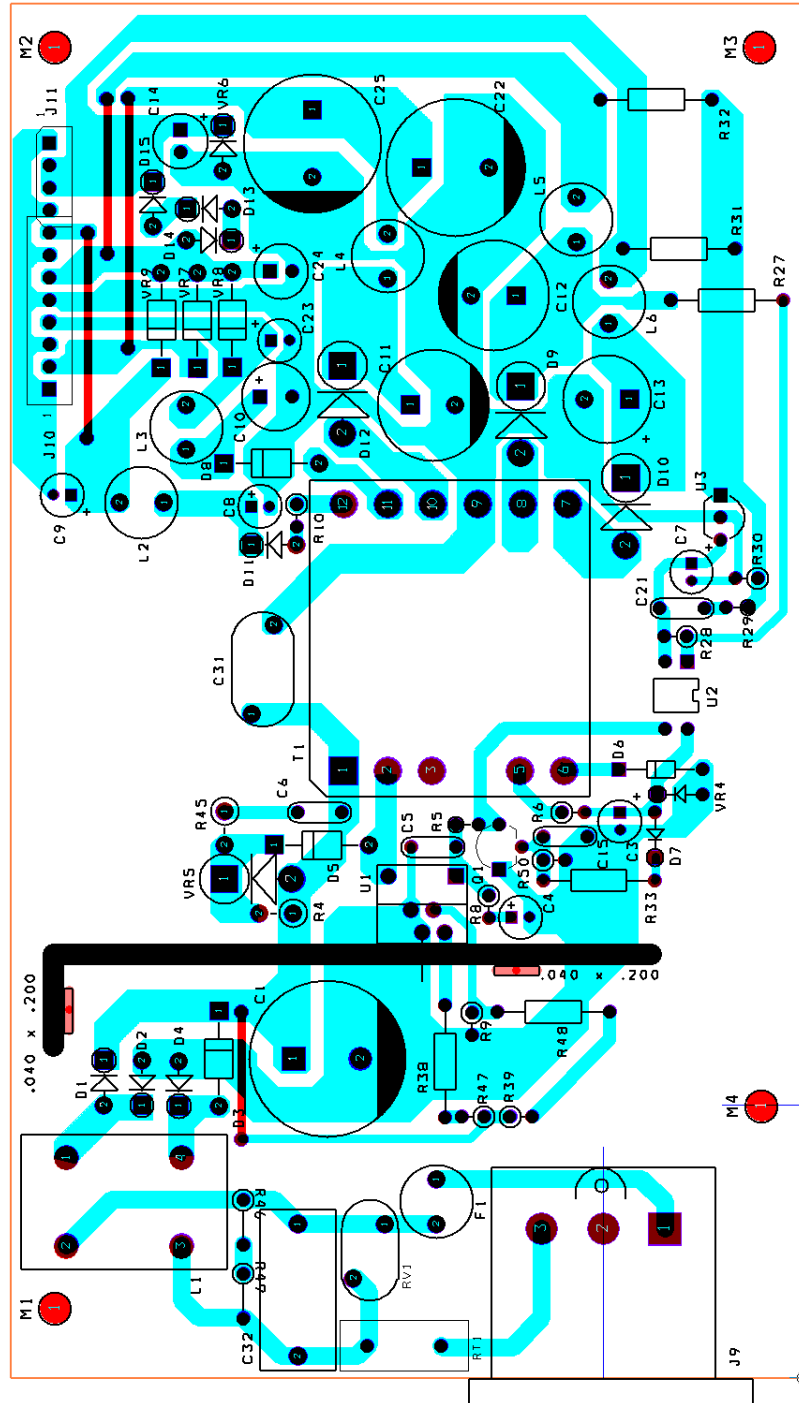


Figure 3 – Printed Circuit Layout

**Note:** Q1, D7, R31, R33, R50, C15, VR6, VR7, VR8 and VR9 are not stuffed on the PCB. C33, C34, C16, R51, R52, R53, Q2 and VR10 are added to the PCB and mounted on the bottom side of the PCB





## 7 Bill Of Materials

Item	Qua.	Value	Part Ref.	Description	Mfg Part Number	Mfg
1	1	150 uF	C1	150 uF, 400 V, Electrolytic, Low ESR, 410 mOhm, (16 x 60)	KMX400VB151M16X60L	United Chemi-Con
2	3	22 uF	C3 C8 C9	22 uF, 50 V, Electrolytic, Very Low ESR, 340 mOhm, (5 x 11)	KZE50VB22RME11LL	United Chemi-Con
3	2	100 uF	C4 C7	100 uF, 10 V, Electrolytic, Gen. Purpose, (5 x 11)	KME10VB101M5X11LL	United Chemi-Con
4	2	100 nF	C5 C21	100 nF, 50 V, Ceramic, X7R	ECU-S1H104KBB	Panasonic
5	2	1 nF	C6 C34	1 nF, 1 kV, Disc Ceramic	NCD102K1KVY5F	NIC Components Corp
6	1	220 uF	C10	220 uF, 35 V, Electrolytic, Very Low ESR, 56 mOhm, (8 x 15)	KZE35VB221MH15LL	United Chemi-Con
7	1	1000 uF	C11	1000 uF, 25 V, Electrolytic, Very Low ESR, 21 mOhm, (12.5 x 20)	KZE25VB102MK20LL	United Chemi-Con
8	1	2200 uF	C12	2200 uF, 10 V, Electrolytic, Very Low ESR, 21 mOhm, (12.5 x 20)	KZE10VB222MK20LL	United Chemi-Con
9	1	1200 uF	C13	1200 uF, 10 V, Electrolytic, Very Low ESR, 23 mOhm, (10 x 20)	KZE10VB122MJ20LL	United Chemi-Con
10	2	220 uF	C14 C24	220 uF, 10 V, Electrolytic, Low ESR, 250 mOhm, (6.3 x 11.5)	LXZ10VB221MF11LL	United Chemi-Con
11	1	10 nF	C16	10 nF, 50 V, Film	ECQ-V1H103JL3	Panasonic
12	2	2700 uF	C22 C25	2700 uF, 25 V, Electrolytic, Very Low ESR, 16 mOhm, (16 x 25)	KZE25VB272ML25LL	United Chemi-Con
13	1	33 uF	C23	33 uF, 35 V, Electrolytic, Very Low ESR, 300 mOhm, (5 x 11)	KZE35VB33RME11LL	United Chemi-Con
14	1	2.2 nF	C31	2.2 nF, Ceramic, Y1	440LD22	Vishay
15	1	330 nF	C32	Safety X capacitor, 270V	Any	
16	1	100 pF	C33	100 pF, 1 kV, Disc Ceramic	NCD101K1KVY5F	NIC Components Corp
17	4	1N4007	D1 D2 D3 D4	1000 V, 1 A, Rectifier, DO-41	1N4007	Vishay
18	1	1N4007GP	D5	1000 V, 1 A, Rectifier, Glass Passivated, 2 us, DO-41	1N4007GP	Vishay
19	1	BAV20	D6	200 V, 200 mA, Fast Switching, 50 ns, DO-35	BAV20	Vishay
20	1	BYV26B	D8	400 V, 1 A, Ultrafast Recovery, 30 ns, SOD57	BYV26B	Philips
21	1	SB560	D9	60 V, 5 A, Schottky, DO-201AD	SB560	Vishay
22	1	SB540	D10	40 V, 5 A, Schottky, DO-201AD	SB540	Vishay
23	1	UF4004	D11	400 V, 1 A, Ultrafast Recovery, 50 ns, DO-41	UF4004	Vishay
24	1	SB5100	D12	100 V, 5 A, Schottky, DO-201AD1	SB5100	Fairchild
25	2	1N4001	D13 D15	50 V, 1 A, Rectifier, DO-41	1N4001	Vishay
26	1	1N5817	D14	20 V, 1 A, Schottky, DO-41	1N5817	Vishay
27	1	2 A	F1	2 A, 250V, Slow, TR5	3,721,200,041	Wickman
28	1	1.560H x 0.080W x 2.675L	HS1	Heatsink, Custom, Vestel, L Shaped		
29	1	CON3	J9	AC Input Receptacle and Accessory Plug, PCBM	161-R301SN13	Kobiconn
30	1	CON8	J10	8 Position (1 x 8) header, 0.1 pitch, Vertical	22-28-4080	Molex
31	1	CON4	J11	4 Position (1 x 4) header, 0.1 pitch, Vertical	22-28-4049	Molex
32	1	6.2 mH	L1	6.2 mH, 1 A, Common Mode Choke	Any	Any
33	5	3.3 uH	L2 L3 L4 L5 L6	3.3 uH, 2.66 A	822LY-3R3M	Toko
34	4	Mounting Holes	M1 M2 M3 M4	PCB Terminal Hole	N/A	N/A
35	1	MCR2206	Q2	400V, 1.5A SCR	N/A	N/A



36	1	47 k	R4	47 k, 5%, 1 W, Metal Oxide	RSF100JB-47K	Yageo
37	1	240	R5	240 R, 5%, 1/8 W, Carbon Film	CFR-12JB-240R	Yageo
38	1	10	R6	10 R, 5%, 1/4 W, Carbon Film	CFR-25JB-10R	Yageo
39	2	6.8	R8 R10	6.8 R, 5%, 1/4 W, Carbon Film	CFR-25JB-6R8	Yageo
40	1	6.81 k	R9	6.81 k, 1%, 1/4 W, Metal Film	MFR-25FBF-6K81	Yageo
41	2	68	R27 R52	68 R, 5%, 1/4 W, Carbon Film	CFR-25JB-68R	Yageo
42	1	1 k	R28	1 k, 5%, 1/4 W, Carbon Film	CFR-25JB-1K0	Yageo
43	1	20 k	R29	20 k, 5%, 1/8 W, Carbon Film	CFR-12JB-20K	Yageo
44	1	10 k	R30	10 k, 1%, 1/4 W, Metal Film	MFR-25FBF-10K0	Yageo
45	1	DNP	R31			
46	1	30.9 k	R32	30.9 k, 1%, 1/4 W, Metal Film	MFR-25FBF-30K9	Yageo
47	2	1 M	R38 R47	1 M, 5%, 1/4 W, Carbon Film	CFR-25JB-1M0	Yageo
48	2	8.2 M	R39 R48	8.2 M, 5%, 1/4 W, Carbon Film	CFR-25JB-8M2	Yageo
49	1	30	R45	30 R, 5%, 1/2 W, Carbon Film	CFR-50JB-30R	Yageo
50	2	560 k	R46 R49	560 k, 5%, 1/4 W, Carbon Film	CFR-25JB-560K	Yageo
51	1	2 k	R51	2 k, 1%, 1/4 W, Metal Film	MFR-25FBF-2K00	Yageo
52	1	100	R53	100 R, 5%, 1/4 W, Carbon Film	CFR-25JB-100R	Yageo
53	1	5	RT1	NTC Thermistor, 5 Ohms, 4.7 A	CL150	Thermometrics
54	1	320 Vac	RV1	320 V, 26 J, 7 mm, RADIAL	V320LA7	Littlefuse
55	1	EER28L	T1	Bobbin, EER28L, Horizontal, 12 pins	YW-195-00B	Yih-Hwa Enterprises
56	1	TOP246Y	U1	TOPSwitch-GX, TOP246Y, TO220-7C	TOP246Y	Power Integrations
57	1	PC817A	U2	Opto coupler, 35 V, CTR 80-160%, 4-DIP	ISP817A, PC817X1	Isocom, Sharp
58	1	LMV431_A	U3	1.24V Shunt Reg IC	LMV431ACZ	National Semiconductor
59	1	1N5250B	VR4	20 V, 5%, 500 mW, DO-35	1N5250B	Microsemi
60	1	P6KE200A	VR5	200 V, 5 W, 5%, DO204AC (DO-15)	P6KE200A	Vishay
61	1	1N5234B	VR10	6.2 V, 5%, 500 mW, DO-35	1N5234B	Microsemi

**NOTE:** Large capacitors were used for the 12V output in order to prevent possible voltage overshoots from the reverse current coming from the Hard Disk Drive motor. Testing with the actual unit may show that these capacitors can be reduced for cost reduction.



## 8 Transformer Specification

### 8.1 Electrical Diagram

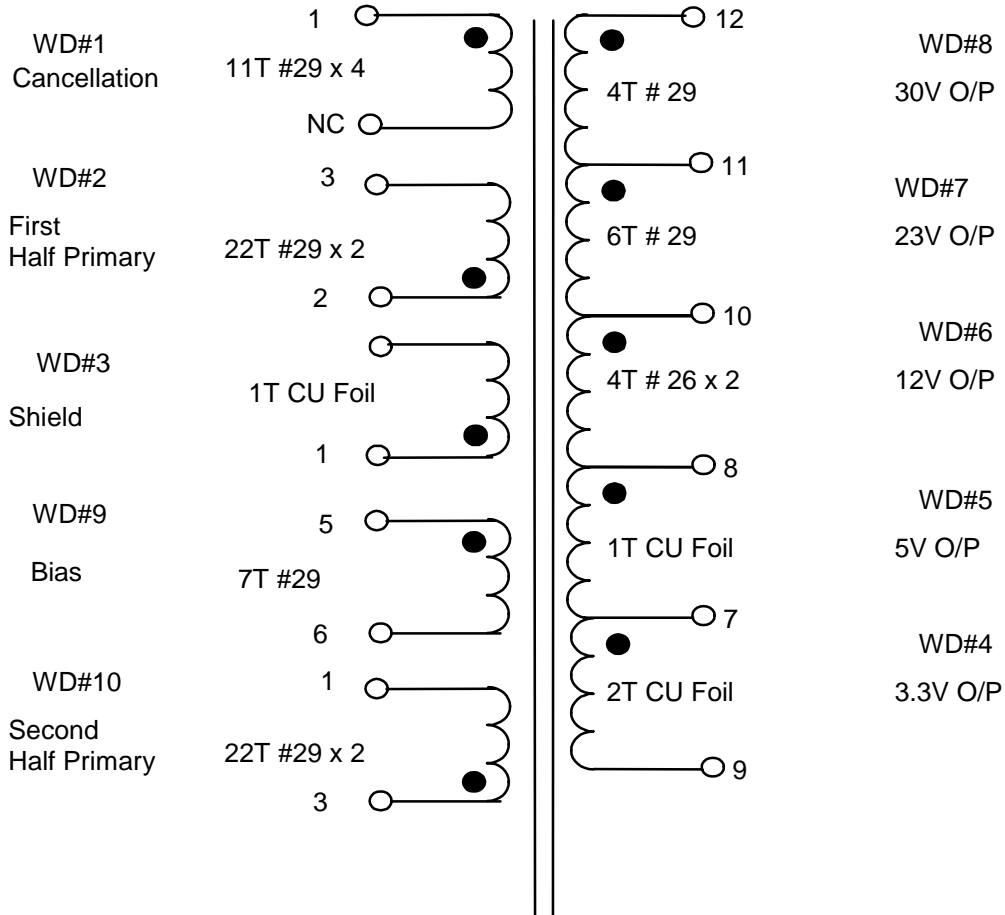


Figure 4 –Transformer Electrical Diagram

### 8.2 Electrical Specifications

<b>Electrical Strength</b>	1 second, 60 Hz, from Pins 1 - 6 to Pins 7 -12	3000 VAC
<b>Primary Inductance</b>	Pins 1-2, all other windings open, measured at 132 kHz, 0.4 VRMS	298 uH, -10/+10%
<b>Resonant Frequency</b>	Pins 1-2, all other windings open	500 kHz (Min.)
<b>Primary Leakage Inductance</b>	Pins 1-2, with Pins 7-12 shorted, measured at 132 kHz, 0.4 VRMS	6 μH (Max.)



**8.3 Materials**

Item	Description
[1]	Core: PC40 EER28L
[2]	Bobbin: BEER28L Horizontal
[3]	Magnet Wire: #29 AWG
[4]	Magnet Wire: #26 AWG
[5]	WD#3, CU Foil: see paragraph 8.4.1 for specification
[6]	WD#4&5 CU Foil: see paragraph 8.4.2 for specification
[7]	Tape: Margin 3 mm
[8]	Tape: 3M 1298 Polyester Film, 15.8mm wide
[9]	Tape: 3M 1298 Polyester Film, 22mm wide
[10]	Teflon Tube

**8.4 Transformer Build Diagram**

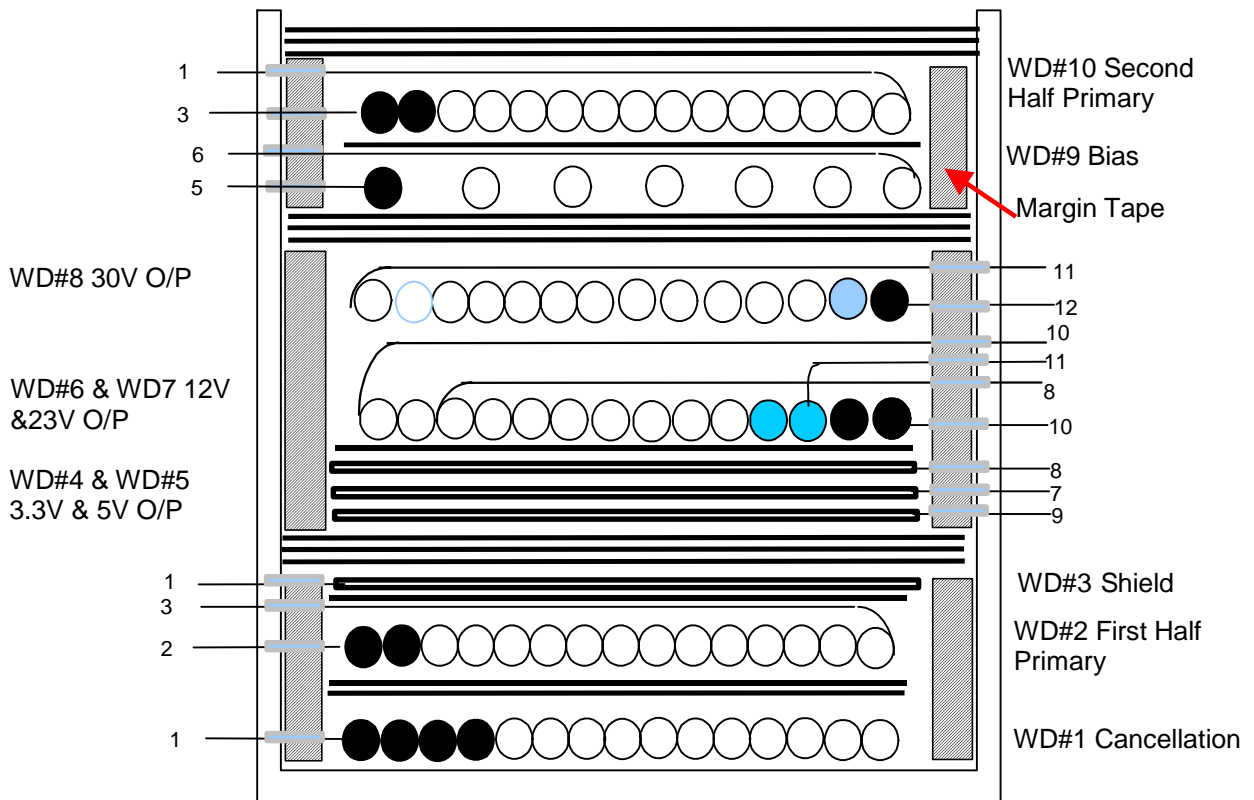


Figure 5 – Transformer Build Diagram.



8.4.1 WD#3 Copper Foil build diagram:

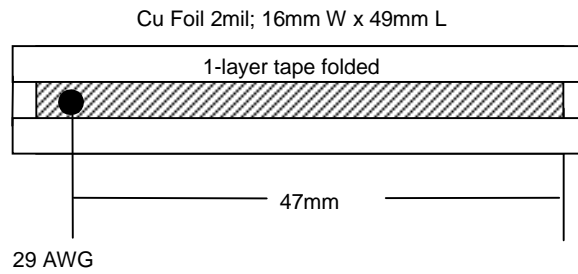


Figure 6 – Copper Foil Build Diagram.

8.4.2 WDG#4 & #5 Copper Foil build diagram:

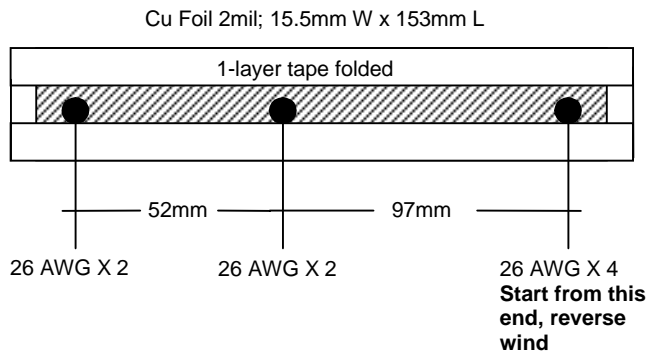


Figure 7 – Copper Foil Build Diagram



## 8.5 Transformer Construction

<b>Bobbin Preparation</b>	Pin1 side of the bobbin orients to the left hand side. The machine spins clock-wise looking from right to left.
<b>Teflon Tube</b>	All winding terminations shall be applied with item [10]
<b>Margin Tape</b>	Wind item [7] at the each pin side of the bobbin to match the height of the first half primary windings.
<b>WD#1 Cancellation</b>	Start on Pin 1, wind 11 turns quad-filar of item [3] from left to right. Wind with tight tension. Cut the wires after finishing 11 <sup>th</sup> turns. Overall, total 11 turns winding should be well fit the entire length of the bobbin.
<b>Insulation</b>	2 Layers of tape [8] for insulation
<b>WD#2 Fist Half Primary</b>	Start on pin 2, wind 22 turns of item [3] from left to right. After finishing the 22 <sup>th</sup> turns, All the wires should be well fit the entire length of the bobbin. Bring the lead back to the left side and finish it on Pin 3.
<b>Insulation</b>	1 Layer of tape [8] for insulation.
<b>WD #3 Shield</b>	Start at Pin 1, wind 1 turns of item [5]. Clock-wise wind with tension. Apply a small piece tape to secure the end of the foil.
<b>Insulation</b>	3 Layers of tape [9] for insulation.
<b>Margin Tape</b>	Wind item [7] at the each pin side of the bobbin to match the height of the secondary windings.
<b>WD #4 &amp; WD #5</b>	Start at pin 9, <b>anti-clock-wise</b> wind 2 turns of item [6]. Wind with tight. Finish the middle termination to pin 7, then continue to wind the last turn and finish it on pin 8. Apply a piece of tape to secure the end of the foil
<b>Insulation</b>	1 Layer of tape [8] for insulation.
<b>WD #6</b>	Start at pin 10, wind 4 turns bifilar of item [4] from right to left. Wind uniformly, in a single layer across entire bobbin evenly. Bring the wire back and finish on pin 8.
<b>WD #7</b>	In the same layer, start at pin 11, wind 6 turns of item [3] from right to left. Wind between the wire gaps of the previous winding, in a single layer across entire bobbin evenly. Bring the wire back and finish on pin 10.
<b>WD #8</b>	In the same layer, start at pin 12, wind 4 turns of item [3] from right to left. Wind uniformly, in a single layer across entire bobbin evenly. Bring the wire back and finish on pin 11.
<b>Insulation</b>	3 Layers of tape [9] for insulation.
<b>WD #9</b>	Start on Pin 5, wind 7 turns item [3] from left to right. Wind with tight tension and scattered across the entire bobbin evenly. After finishing 7 <sup>th</sup> turn, bring the wire back and finish it on Pin 6.
<b>Insulation</b>	2 Layer of tape [8] for insulation.
<b>WD #10</b>	Start on pin 3, wind 22 turns of item [3] from left to right. After finishing the 22 <sup>th</sup> turns, All the wires should be well fit the entire length of the bobbin. Bring the lead back to the left side and finish it on Pin 1.
<b>Insulation</b>	3 Layers of tape [9] for insulation.
<b>Finish</b>	Grind the core to get 298uH. Secure the core with tape.



**8.6 Transformer Spreadsheets**

ACDC_TOPSwitchGX_032204 ; Rev.1.9; Copyright Power Integrations Inc. 2004	INPUT	INFO	INFO	OUTPU T	OUTPU T	UNIT	TOP_GX_FX_032204.xls: TOPSwitch-GX/FX Continuous/Discontinuous Flyback Transformer Design Spreadsheet
<b>ENTER APPLICATION VARIABLES</b>							<b>Customer</b>
VACMIN	85					Volts	Minimum AC Input Voltage
VACMAX	265					Volts	Maximum AC Input Voltage
fL	50					Hertz	AC Mains Frequency
VO	5					Volts	Output Voltage
PO	53					Watts	Output Power
$\eta$	0.7						Efficiency Estimate
Z	0.5						Loss Allocation Factor
VB	15					Volts	Bias Voltage
tC	3					mSeconds	Bridge Rectifier Conduction Time Estimate
CIN	150					uFarads	Input Filter Capacitor
<b>ENTER TOPSWITCH-GX VARIABLES</b>							
TOP-GX	<b>TOP246</b>					Universal	115 Doubled/230V
Chosen Device		TOP246	TOP246	Power Out	Power Out	90W	125W
KI	1						External Ilimit reduction factor (KI=1.0 for default ILIMIT, KI <1.0 for lower ILIMIT)
ILIMITMIN				2.511	2.511	Amps	Use 1% resistor in setting external ILIMIT
ILIMITMAX				2.889	2.889	Amps	Use 1% resistor in setting external ILIMIT
Frequency (F)=132kHz, (H)=66kHz	<b>F</b>						Full (F) frequency option - 132kHz
fS				132000	132000	Hertz	TOPSwitch-GX Switching Frequency: Choose between 132 kHz and 66 kHz
fSmin				124000	124000	Hertz	TOPSwitch-GX Minimum Switching Frequency
fSmax				140000	140000	Hertz	TOPSwitch-GX Maximum Switching Frequency
VOR	80					Volts	Reflected Output Voltage
VDS	13					Volts	TOPSwitch on-state Drain to Source Voltage
VD	0.5					Volts	Output Winding Diode Forward Voltage Drop
VDB	0.7					Volts	Bias Winding Diode Forward Voltage Drop
KP	0.47						Ripple to Peak Current Ratio (0.4 < KRP < 1.0 : 1.0 < KDP < 6.0)
<b>ENTER TRANSFORMER CORE/CONSTRUCTION VARIABLES</b>							
Core Type	<b>eer28</b>						
Core		EER28	EER28			P/N:	PC40EER28-Z
Bobbin		EER28 BOBBIN	EER28_BOBBIN			P/N:	BEER-28-1112CPH
AE				0.821	0.821	cm^2	Core Effective Cross Sectional Area
LE				6.4	6.4	cm	Core Effective Path Length
AL				2870	2870	nH/T^2	Ungapped Core Effective Inductance
BW				16.7	16.7	mm	Bobbin Physical Winding Width
M	3					mm	Safety Margin Width (Half the Primary to Secondary Creepage Distance)
L	2						Number of Primary Layers
NS	3						Number of Secondary Turns



<b>DC INPUT VOLTAGE PARAMETERS</b>						
VMIN				86	86	Volts Minimum DC Input Voltage
VMAX				375	375	Volts Maximum DC Input Voltage
<b>CURRENT WAVEFORM SHAPE PARAMETERS</b>						
DMAX				0.52	0.52	 Maximum Duty Cycle
I AVG				0.88	0.88	Amps Average Primary Current
IP				2.20	2.20	Amps Peak Primary Current
IR				1.03	1.03	Amps Primary Ripple Current
IRMS				1.24	1.24	Amps Primary RMS Current
<b>TRANSFORMER PRIMARY DESIGN PARAMETERS</b>						
LP				298	298	uHenries Primary Inductance
NP				44	44	 Primary Winding Number of Turns
NB				9	9	 Bias Winding Number of Turns
ALG				156	156	nH/T <sup>2</sup> Gapped Core Effective Inductance
BM				1830	1830	Gauss Maximum Flux Density at PO. VMIN (BM<3000)
BP				2401	2401	Gauss Peak Flux Density (BP<4200)
BAC				430	430	Gauss AC Flux Density for Core Loss Curves (0.5 X Peak to Peak)
ur				1780	1780	 Relative Permeability of Ungapped Core
LG				0.62	0.62	mm Gap Length (Lg > 0.1 mm)
BWE				21.4	21.4	mm Effective Bobbin Width
OD				0.49	0.49	mm Maximum Primary Wire Diameter including insulation
INS				0.07	0.07	mm Estimated Total Insulation Thickness (= 2 * film thickness)
DIA				0.43	0.43	mm Bare conductor diameter
AWG				26	26	AWG Primary Wire Gauge (Rounded to next smaller standard AWG value)
CM				256	256	Cmils Bare conductor effective area in circular mils
CMA				207	207	Cmils/Amp Primary Winding Current Capacity (200 < CMA < 500)
<b>TRANSFORMER SECONDARY DESIGN PARAMETERS (SINGLE OUTPUT / SINGLE OUTPUT EQUIVALENT)</b>						
<b>Lumped parameters</b>						
ISP				32.03	32.03	Amps Peak Secondary Current
ISRMS				17.18	17.18	Amps Secondary RMS Current
IO				10.60	10.60	Amps Power Supply Output Current
IRIPPLE				13.52	13.52	Amps Output Capacitor RMS Ripple Current
CMS				3437	3437	Cmils Secondary Bare Conductor minimum circular mils
AWGS				14	14	AWG Secondary Wire Gauge (Rounded up to next larger standard AWG value)
DIAS				1.63	1.63	mm Secondary Minimum Bare Conductor Diameter
ODS				3.57	3.57	mm Secondary Maximum Outside Diameter for Triple Insulated Wire
INSS				0.97	0.97	mm Maximum Secondary Insulation Wall Thickness
<b>VOLTAGE STRESS PARAMETERS</b>						
VDRAIN				563	563	Volts Maximum Drain Voltage Estimate (Includes Effect of Leakage Inductance)
PIVS				31	31	Volts Output Rectifier Maximum Peak Inverse Voltage
PIVB				89	89	Volts Bias Rectifier Maximum Peak Inverse Voltage





<b>TRANSFORMER SECONDARY DESIGN PARAMETERS (MULTIPLE OUTPUTS)</b>							
<b>1st output</b>							
VO1	3.3					Volts	Output Voltage
IO1	1.500					Amps	Output DC Current
PO1			4.95	4.95		Watts	Output Power
VD1	0.5					Volts	Output Diode Forward Voltage Drop
NS1			2.07	2.07			Output Winding Number of Turns
ISRMS1			2.432	2.432		Amps	Output Winding RMS Current
IRIPPLE1			1.91	1.91		Amps	Output Capacitor RMS Ripple Current
PIVS1			21	21		Volts	Output Rectifier Maximum Peak Inverse Voltage
CMS1			486	486		Cmils	Output Winding Bare Conductor minimum circular mils
AWGS1			23	23		AWG	Wire Gauge (Rounded up to next larger standard AWG value)
DIAS1			0.58	0.58		mm	Minimum Bare Conductor Diameter
ODS1			5.16	5.16		mm	Maximum Outside Diameter for Triple Insulated Wire
<b>2nd output</b>							
VO2	12.0					Volts	Output Voltage
IO2	0.700					Amps	Output DC Current
PO2			8.40	8.40		Watts	Output Power
VD2	0.5					Volts	Output Diode Forward Voltage Drop
NS2			6.82	6.82			Output Winding Number of Turns
ISRMS2			1.135	1.135		Amps	Output Winding RMS Current
IRIPPLE2			0.89	0.89		Amps	Output Capacitor RMS Ripple Current
PIVS2			71	71		Volts	Output Rectifier Maximum Peak Inverse Voltage
CMS2			227	227		Cmils	Output Winding Bare Conductor minimum circular mils
AWGS2			26	26		AWG	Wire Gauge (Rounded up to next larger standard AWG value)
DIAS2			0.41	0.41		mm	Minimum Bare Conductor Diameter
ODS2			1.57	1.57		mm	Maximum Outside Diameter for Triple Insulated Wire
<b>3rd output</b>							
VO3	22.0					Volts	Output Voltage
IO3	0.100					Amps	Output DC Current
PO3			2.20	2.20		Watts	Output Power
VD3	0.7					Volts	Output Diode Forward Voltage Drop
NS3			12.38	12.38			Output Winding Number of Turns
ISRMS3			0.162	0.162		Amps	Output Winding RMS Current
IRIPPLE3			0.13	0.13		Amps	Output Capacitor RMS Ripple Current
PIVS3			128	128		Volts	Output Rectifier Maximum Peak Inverse Voltage
CMS3			32	32		Cmils	Output Winding Bare Conductor minimum circular mils
AWGS3			34	34		AWG	Wire Gauge (Rounded up to next larger standard AWG value)
DIAS3			0.16	0.16		mm	Minimum Bare Conductor Diameter
ODS3			0.86	0.86		mm	Maximum Outside Diameter for Triple Insulated Wire



## 9 Performance Data

All measurements performed at room temperature, 60 Hz input frequency.

### 9.1 Line and Load Regulation

The test was done at 85 Vac and 265 Vac input, E-loads were used for the test.

Vac Input	3.3V		5V		12V		23V		30V	
	V <sub>O/P</sub> (V)	I <sub>O/P</sub> (A)	V <sub>O/P</sub> (V)	I <sub>O/P</sub> (A)	V <sub>O/P</sub> (V)	I <sub>O/P</sub> (A)	V <sub>O/P</sub> (V)	I <sub>O/P</sub> (A)	V <sub>O/P</sub> (V)	I <sub>O/P</sub> (A)
85V	3.325	1.5	5.01	2	12.62	2	23.5	0.5	31.0	0.08
	3.31	1	5.01	2	12.64	2	23.57	0.5	31	0.08
	3.39	0.5	5.01	2	12.62	2	23.54	0.5	30.9	0.08
	3.18	1.5	5.02	1	12.3	2	22.97	0.5	30.2	0.08
	3.15	1.5	5.03	0.5	12.12	2	22.63	0.5	29.7	0.08
	3.26	1.5	5.01	2	12.87	1	23.69	0.5	31.16	0.08
	3.26	1.5	5.01	2	13.02	0.5	23.65	0.5	31.1	0.08
	3.25	1.5	5.01	2	12.7	2	23.94	0.25	31.29	0.08
	3.26	1.5	5.01	2	12.7	2	23.68	0.5	33.8	20
	3.29	0.375	5.06	0.5	12.35	0.5	22.8	0.125	30.5	20
265V	3.238	1.5	5.01	2	12.35	2	22.80	0.5	30.5	0.08
	3.3	1	5.01	2	12.47	2	23.26	0.5	30.6	0.08
	3.36	0.5	5.01	2	12.46	2	23.22	0.5	30.6	0.08
	3.19	1.5	5.02	1	12.22	2	22.76	0.5	30	0.08
	3.17	1.5	5.03	0.5	12.09	2	22.49	0.5	29.7	0.08
	3.26	1.5	5.01	2	12.67	1	23.24	0.5	30.7	0.08
	3.26	1.5	5.01	2	12.89	0.5	23.29	0.5	31.8	0.08
	3.25	1.5	5.01	2	12.48	2	23.94	0.25	31.29	0.08
	3.24	1.5	5.01	2	12.47	2	23.23	0.5	31.5	20
	3.29	0.375	5.06	0.5	12.35	0.5	22.78	0.125	30.4	20



### 9.2 Efficiency

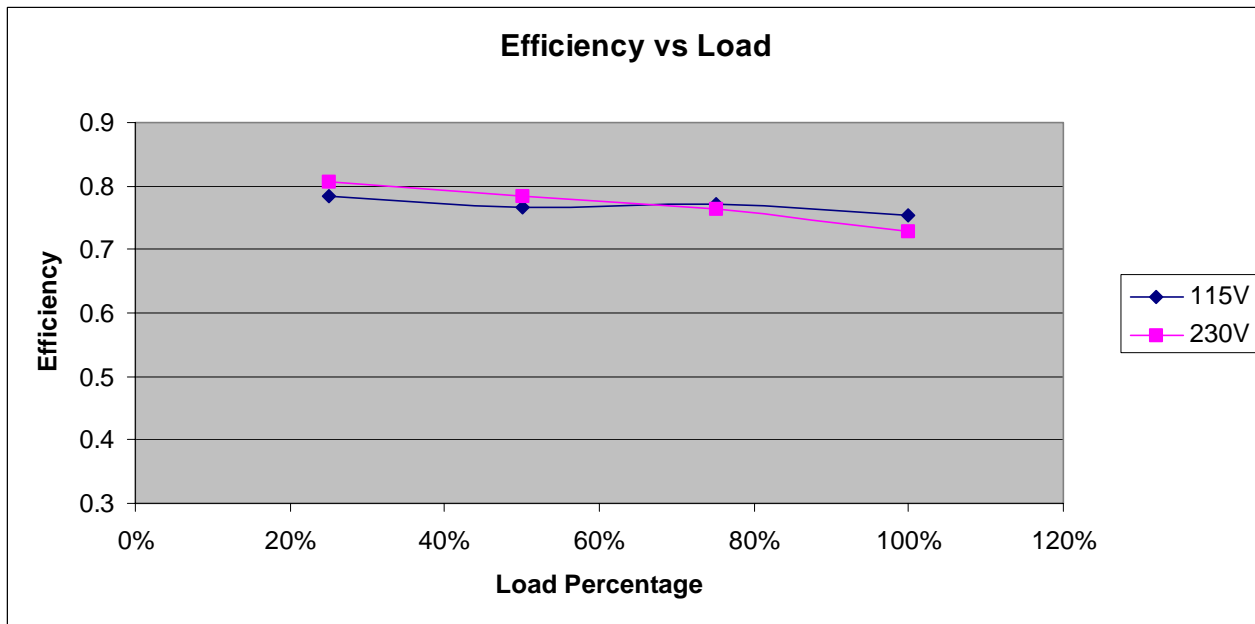


Figure 8 – Efficiency

### 9.3 Overvoltage Protection

Test Result: Under the all line and load conditions, short out the regulation optocoupler LED to simulate a loop failure. The power supply goes into auto restart mode, until the fault is removed.

Comment: **PASS**



## 10 Thermal Performance

Test Condition: The power supply was set on the bench and the all the loads were at full load except 12V loading at 1A. The total output power was 41W.

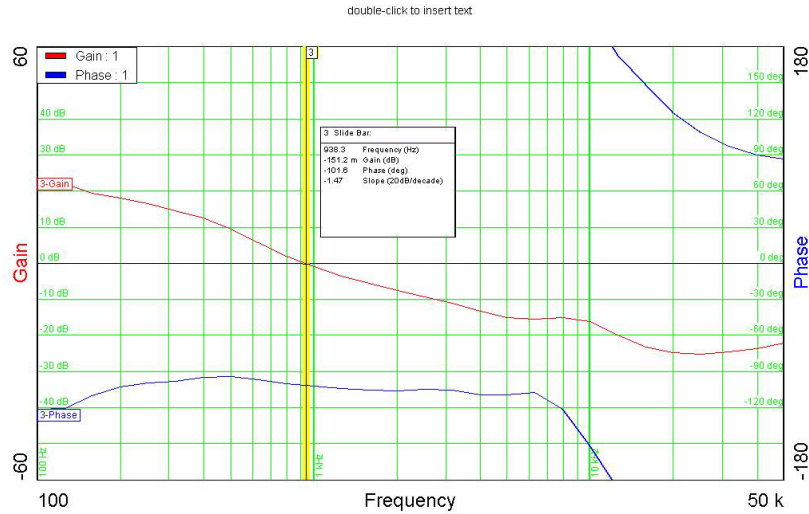
Temperature (°C)		
Item	85Vac	265Vac
	(°C)	
Ambient (°C)	25	
TOP246Y (U1)	80	78



## 11 Control Loop Measurements

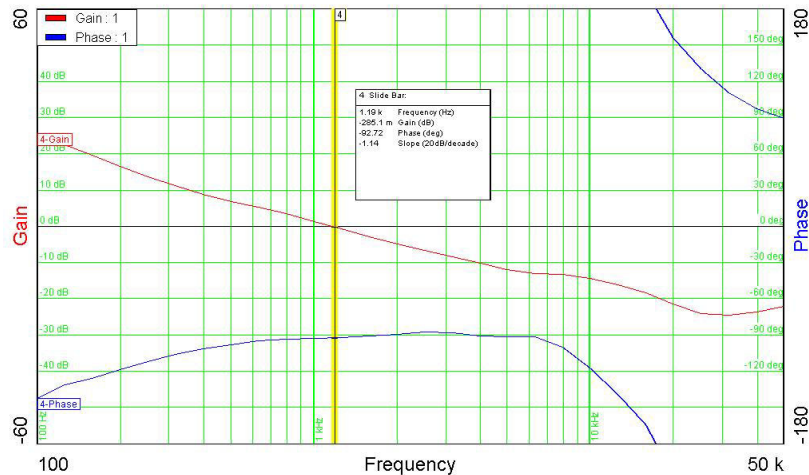
The power supply is loaded at full load 53W to show worst case.

### 11.1 110 VAC Maximum Continuous Load



**Figure 9** - Gain-Phase Plot, 110 VAC, 53W Steady State Load.  
 Vertical Scale: Gain = 10 dB/div, Phase = 30°/div.  
 Crossover Frequency = 938 Hz Phase Margin = 78.4°

### 11.2 230 VAC Maximum Continuous Load



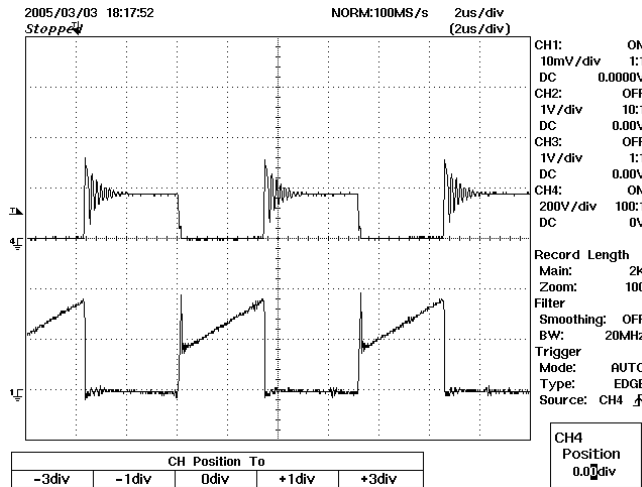
**Figure 10** - Gain-Phase Plot, 230 VAC, 53W Steady State Load.  
 Vertical Scale: Gain = 10 dB/div, Phase = 30°/div.  
 Crossover Frequency = 1.19 kHz, Phase Margin = 87.28°



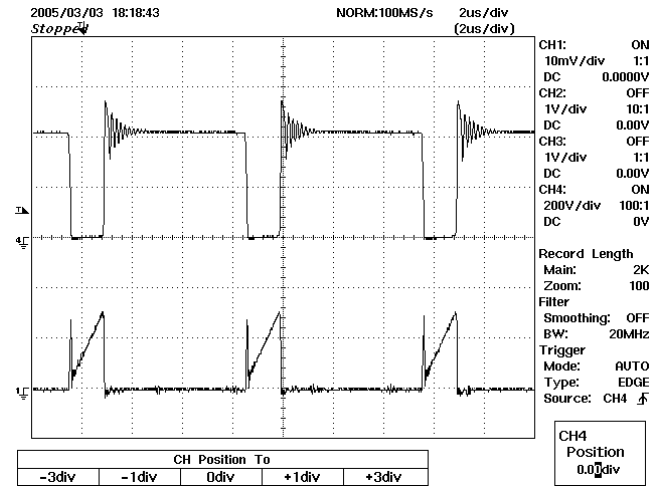
## 12 Waveforms

Waveforms were taken at 25°C. All outputs are loaded at full load, total 53W.

### 12.1 Drain Voltage and Current, Normal Operation

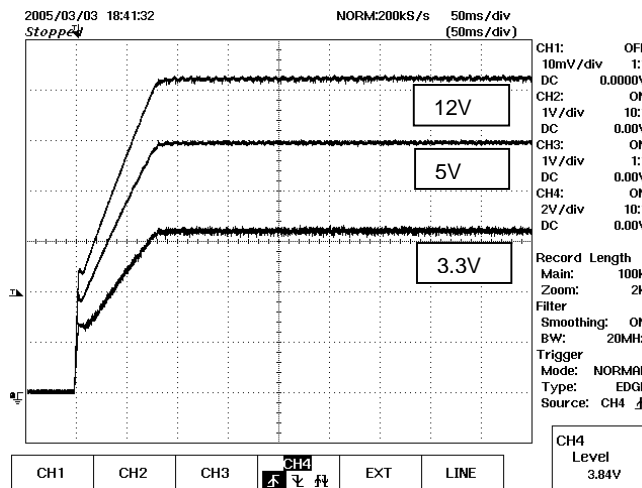


**Figure 11 - 85 VAC, Full Load.**  
Lower:  $I_{DRAIN}$ , 1 A / div  
Upper:  $V_{DRAIN}$ , 200 V, 2  $\mu$ s / div

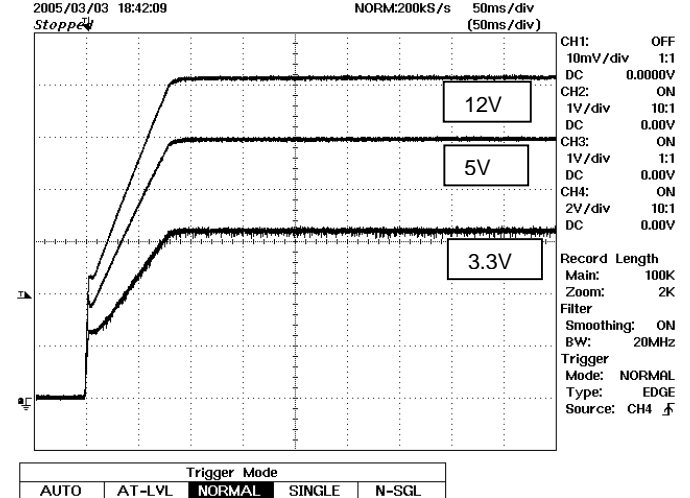


**Figure 12 - 265 VAC, Full Load**  
Lower:  $I_{DRAIN}$ , 1 A / div  
Upper:  $V_{DRAIN}$ , 200 V, 2  $\mu$ s / div

### 12.2 Output Voltage Start-up Profile



**Figure 13 – Start-up Profile, 85 VAC**  
1V/div for 3.3V & 5V, 2V/div for 12V, 50 ms / div.



**Figure 14 – Start-up Profile, 265 VAC**  
1V/div for 3.3V & 5V, 2V/div for 12V, 50 ms / div.



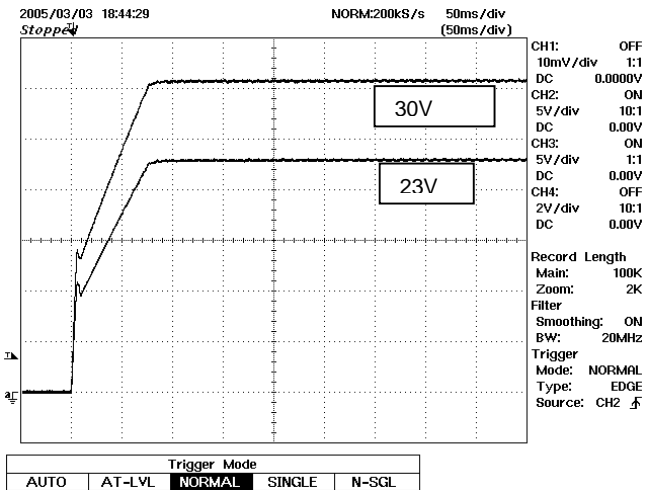


Figure 15 – Start-up Profile, 85 VAC  
5V/div for 23V & 30V, 50 ms / div.

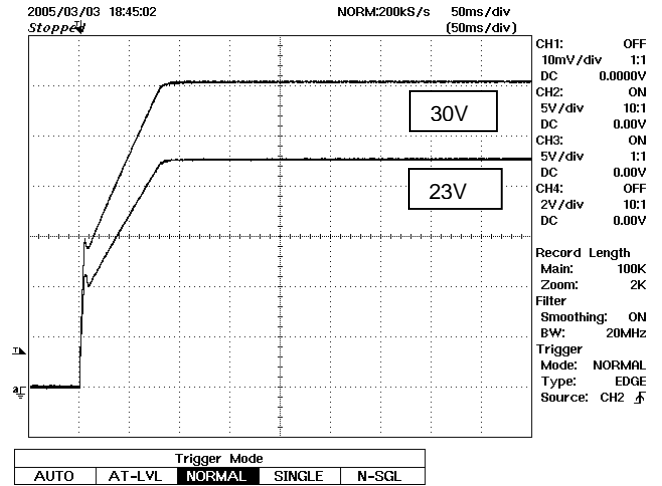


Figure 16 – Start-up Profile, 265 VAC  
5V/div for 23V & 30V, 50 ms / div.

### 12.3 Drain Voltage Start-up Profile

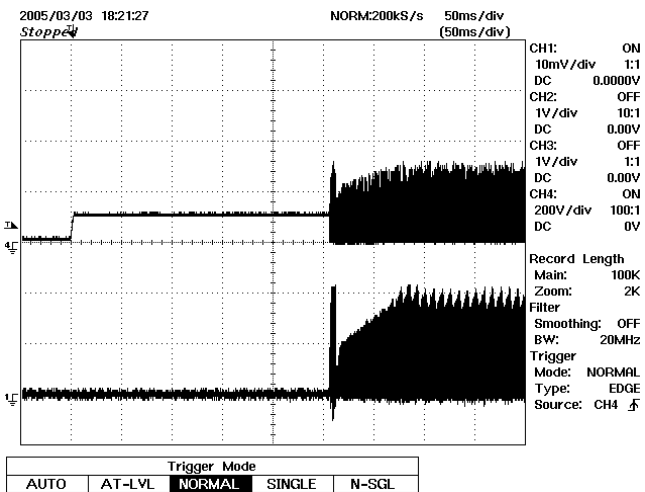


Figure 17 - 90 VAC Input. Lower:  $I_{DRAIN}$ , 1 A / div  
Upper:  $V_{DRAIN}$ , 200 V, 50ms / div.

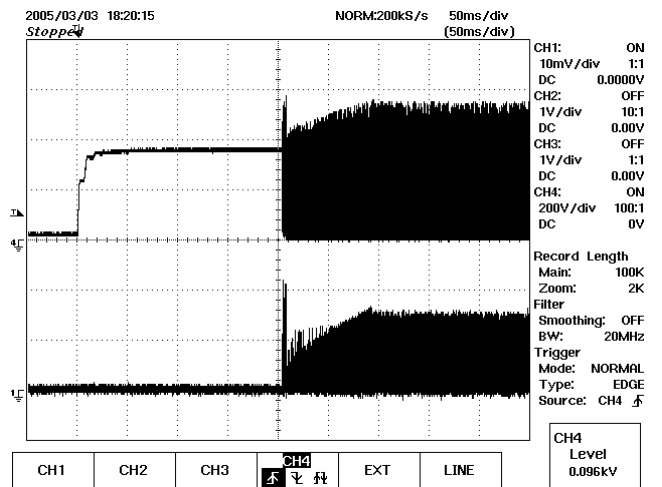


Figure 18 - 265 VAC Input. Lower:  $I_{DRAIN}$ , 1 A / div  
Upper:  $V_{DRAIN}$ , 200 V, 50ms / div.

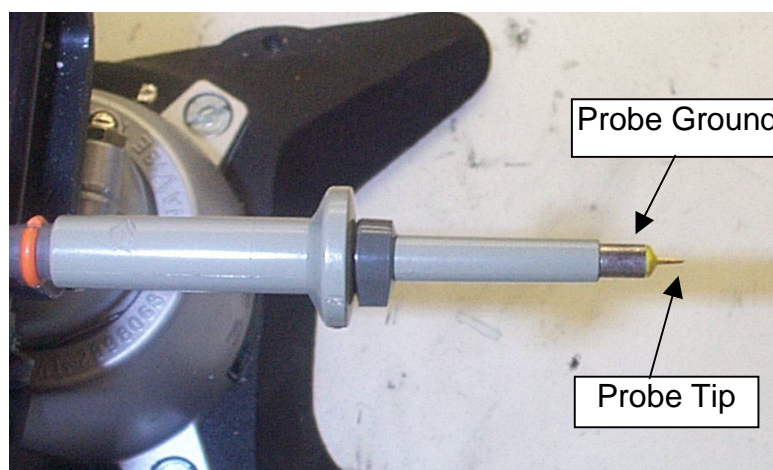


## 13 Output Ripple Measurements

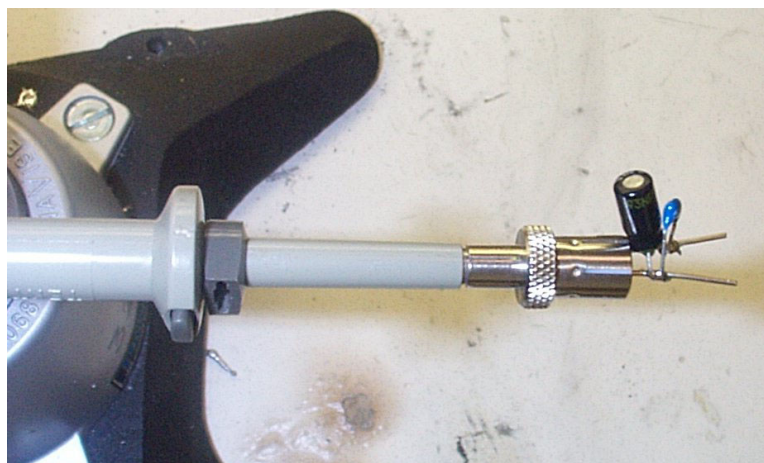
### 13.1.1 Ripple Measurement Technique

For DC output ripple measurements, a modified oscilloscope test probe must be utilized in order to reduce spurious signals due to pickup. Details of the probe modification are provided in Figure 19 and Figure 20.

The 5125BA probe adapter is affixed with two capacitors tied in parallel across the probe tip. The capacitors include one (1) 0.1  $\mu\text{F}/50\text{ V}$  ceramic type and one (1) 1.0  $\mu\text{F}/50\text{ V}$  aluminum electrolytic. ***The aluminum electrolytic type capacitor is polarized, so proper polarity across DC outputs must be maintained (see below).***



**Figure 19** - Oscilloscope Probe Prepared for Ripple Measurement. (End Cap and Ground Lead Removed)



**Figure 20** - Oscilloscope Probe with Probe Master 5125BA BNC Adapter. (Modified with wires for probe ground for ripple measurement, and two parallel decoupling capacitors added)



### 13.1.2 Measurement Results

The power supply was at 41W resistor load. 25Deg.C ambient.

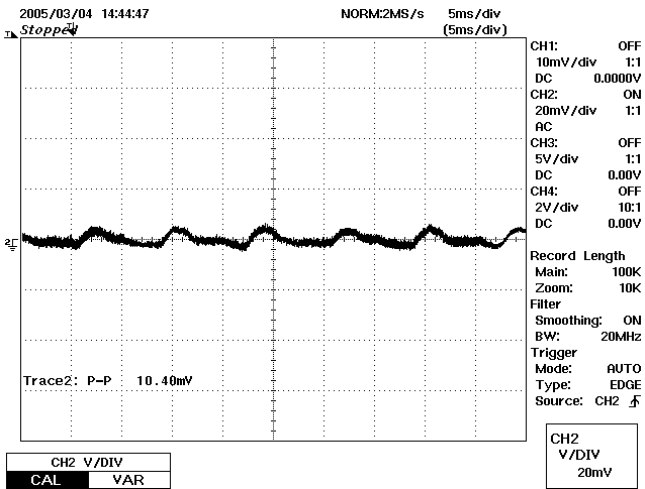


Figure 21 85 VAC, 3.3V. 5 ms, 20 mV / div

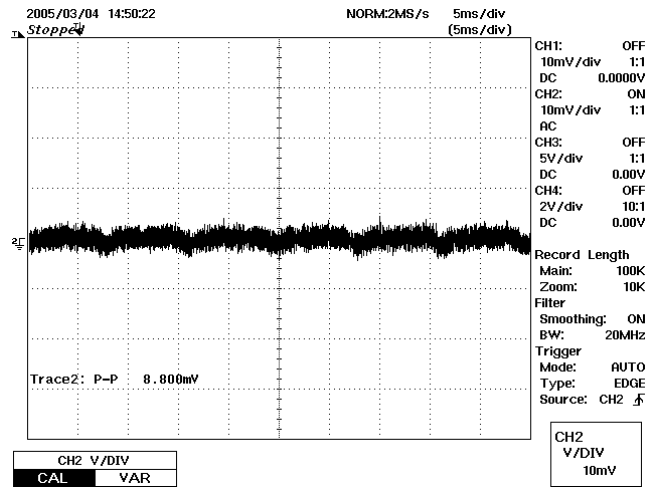


Figure 22 265 VAC, 3.3V. 5 ms, 10 mV / div

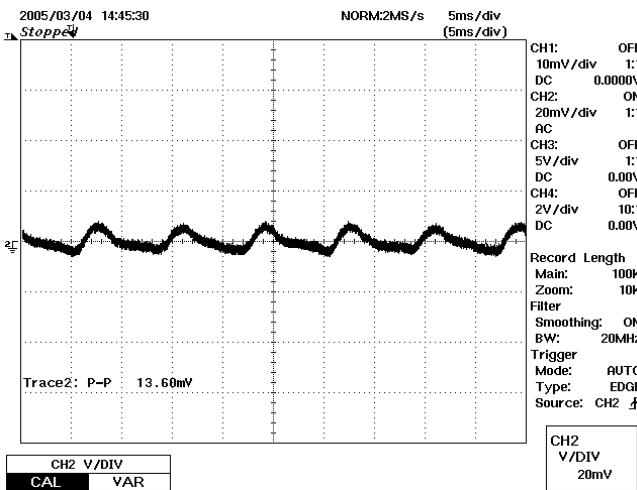


Figure 23 85 VAC, 5V. 5 ms, 20 mV / div

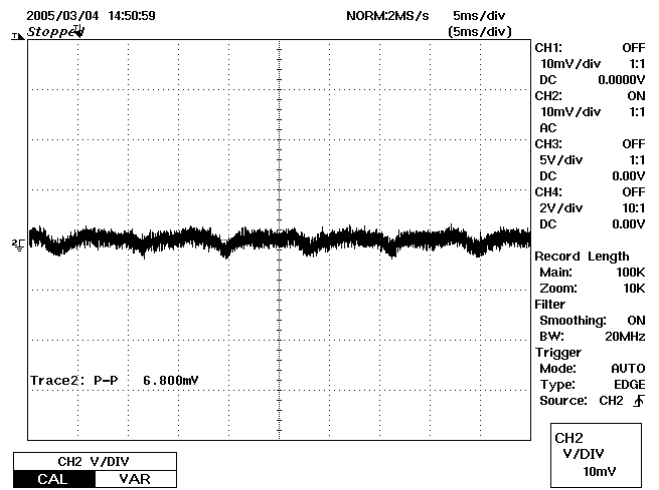


Figure 24 265 VAC, 5V. 5 ms, 10 mV / div



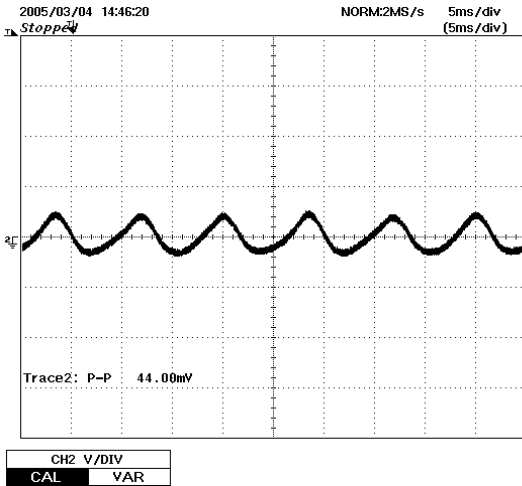


Figure 25 85 VAC, 12V. 5 ms, 50 mV / div

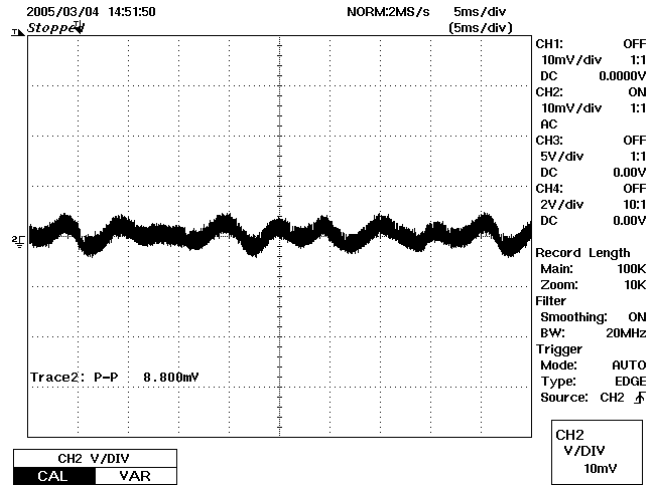


Figure 26 265 VAC, 12V. 5 ms, 10 mV / div

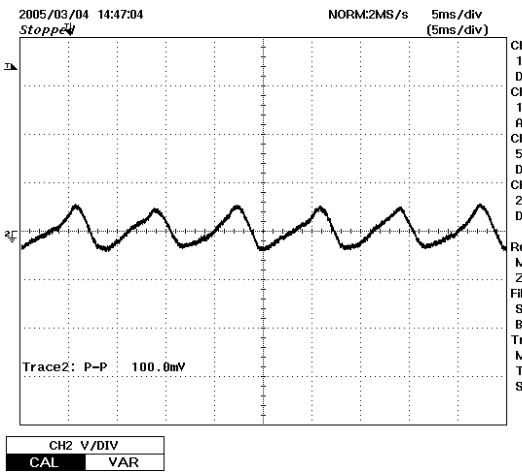


Figure 27 85 VAC, 23V. 5 ms, 100 mV / div

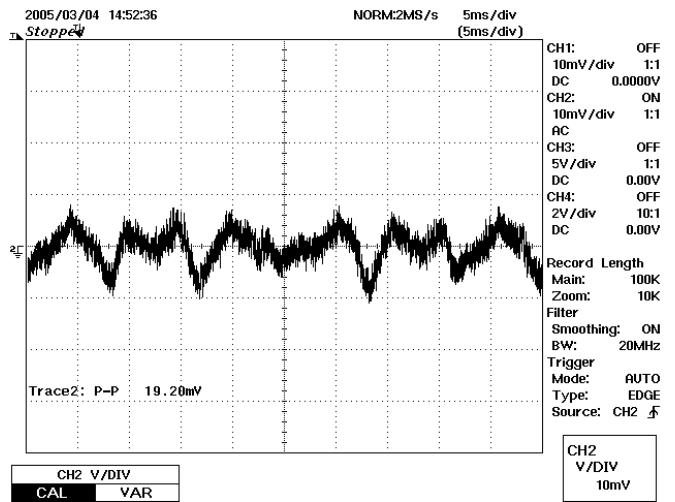


Figure 28 265 VAC, 23V. 5 ms, 10 mV / div



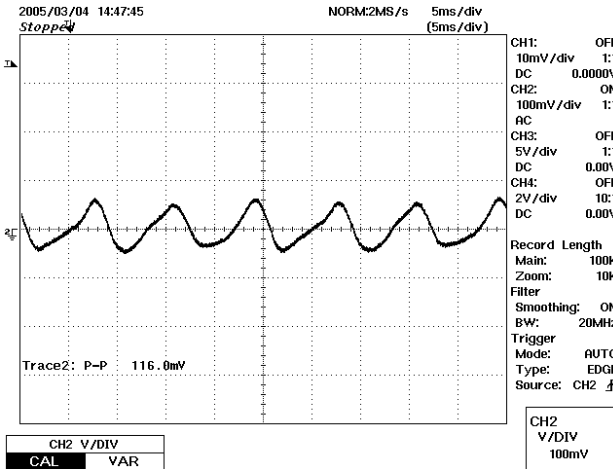


Figure 29 85 VAC, 30V. 5 ms, 100 mV / div

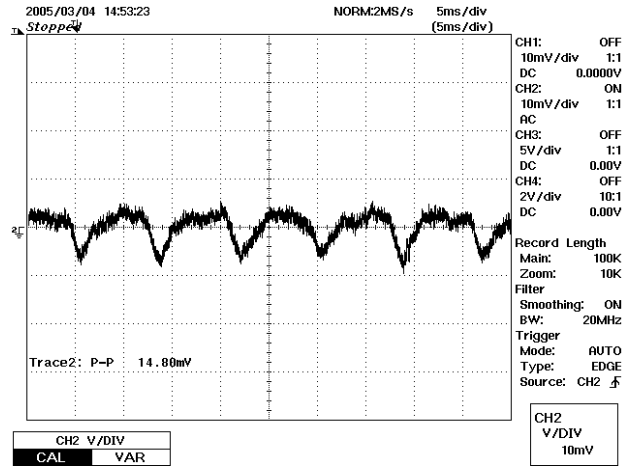


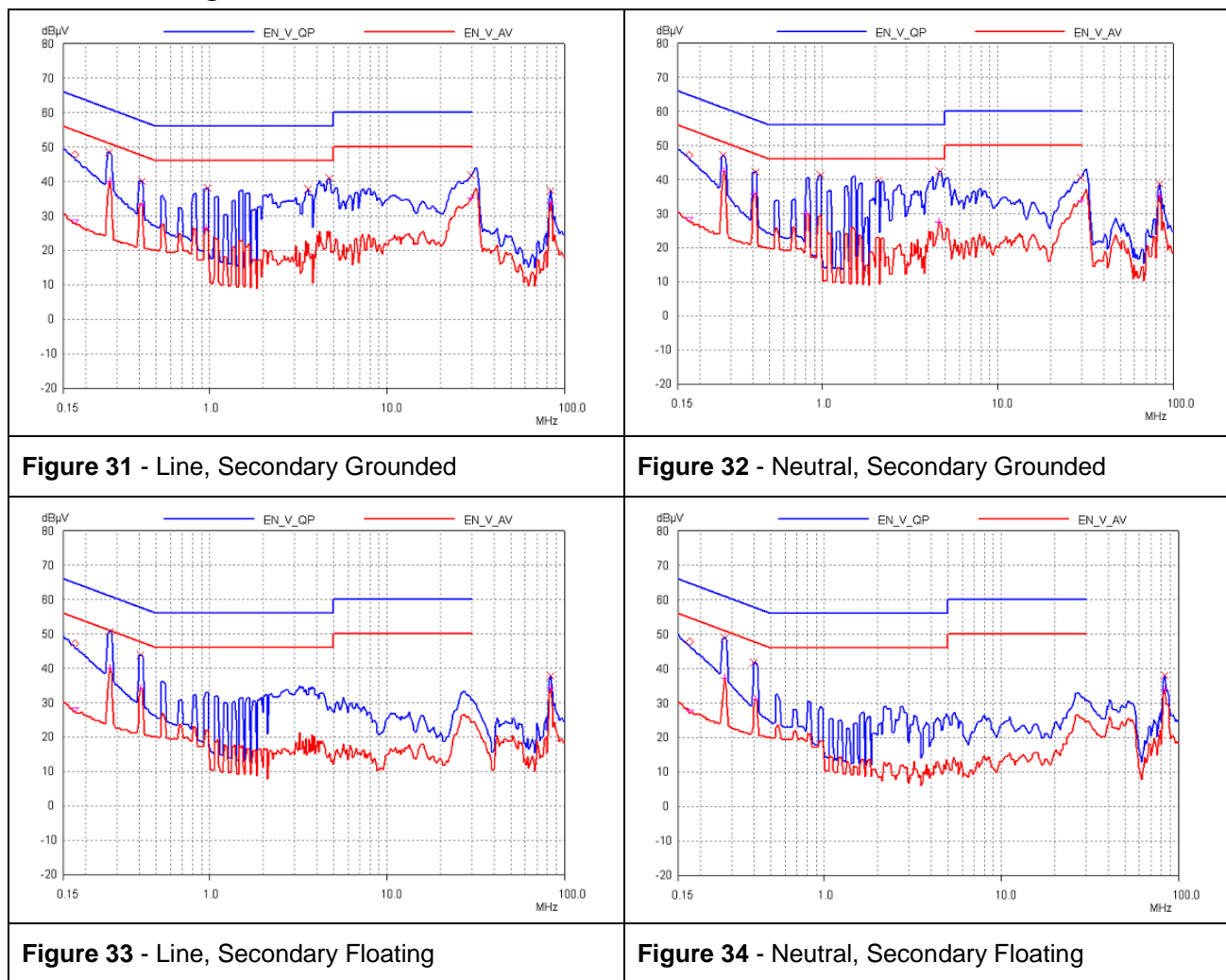
Figure 30 265 VAC, 30V. 5 ms, 10 mV / div



## 14 Conducted EMI

EMI was tested at room temperature and 230 VAC input. The power supply was at 41W resistor load. Two conditions were tested. (1) Secondary return connected to LISN ground (worst case), and (2) with no connection. Blue line is QP, Red line is AVG.

### 14.1 230V High Line EMI



**15 Revision History**

<b>Date</b>	<b>Author</b>	<b>Revision</b>	<b>Description &amp; changes</b>	<b>Reviewed</b>
March 7, 2005	DZ	1.0	Initial release	AM / VC



For the latest updates, visit our Web site: [www.powerint.com](http://www.powerint.com)

Power Integrations may make changes to its products at any time. Power Integrations has no liability arising from your use of any information, device or circuit described herein nor does it convey any license under its patent rights or the rights of others. POWER INTEGRATIONS MAKES NO WARRANTIES HEREIN AND SPECIFICALLY DISCLAIMS ALL WARRANTIES INCLUDING, WITHOUT LIMITATION, THE IMPLIED WARRANTIES OF MERCHANTABILITY, FITNESS FOR A PARTICULAR PURPOSE, AND NON-INFRINGEMENT OF THIRD PARTY RIGHTS.

#### PATENT INFORMATION

The products and applications illustrated herein (including circuits external to the products and transformer construction) may be covered by one or more U.S. and foreign patents or potentially by pending U.S. and foreign patent applications assigned to Power Integrations. A complete list of Power Integrations' patents may be found at [www.powerint.com](http://www.powerint.com).

The PI Logo, **TOPSwitch**, **TinySwitch**, **LinkSwitch**, and **EcoSmart** are registered trademarks of Power Integrations. **PI Expert** and **DPA-Switch** are trademarks of Power Integrations.

© Copyright 2004, Power Integrations.

### Power Integrations Worldwide Sales Support Locations

#### WORLD HEADQUARTERS

5245 Hellyer Avenue,  
San Jose, CA 95138, USA  
Main: +1-408-414-9200  
Customer Service:  
Phone: +1-408-414-9665  
Fax: +1-408-414-9765  
e-mail:  
[usasales@powerint.com](mailto:usasales@powerint.com)

#### GERMANY

Rueckertstrasse 3,  
D-80336, Munich, Germany  
Phone: +49-895-527-3910  
Fax: +49-895-527-3920  
e-mail: [eurosales@powerint.com](mailto:eurosales@powerint.com)

#### JAPAN

Keihin-Tatemono 1st Bldg.  
12-20 Shin-Yokohama,  
2-Chome,  
Kohoku-ku, Yokohama-shi,  
Kanagawa 222-0033, Japan  
Phone: +81-45-471-1021  
Fax: +81-45-471-3717  
e-mail:  
[japansales@powerint.com](mailto:japansales@powerint.com)

#### TAIWAN

17F-3, No. 510,  
Chung Hsiao E. Rd., Sec. 5,  
Taipei, Taiwan 110, R.O.C.  
Phone: +886-2-2727-1221  
Fax: +886-2-2727-1223  
e-mail:  
[taiwansales@powerint.com](mailto:taiwansales@powerint.com)

#### CHINA (SHANGHAI)

Rm 807, Pacheer,  
Commercial Centre,  
555 Nanjing West Road,  
Shanghai, 200041, China  
Phone: +86-21-6215-5548  
Fax: +86-21-6215-2468  
e-mail:  
[chinasales@powerint.com](mailto:chinasales@powerint.com)

#### INDIA (TECHNICAL SUPPORT)

Innovatech  
261/A, Ground Floor  
7th Main, 17th Cross,  
Sadashivanagar  
Bangalore, India, 560080  
Phone: +91-80-5113-8020  
Fax: +91-80-5113-8023  
e-mail: [indiasales@powerint.com](mailto:indiasales@powerint.com)

#### KOREA

8th Floor, DongSung Bldg.  
17-8 Yoido-dong,  
Youngdeungpo-gu,  
Seoul, 150-874, Korea  
Phone: +82-2-782-2840  
Fax: +82-2-782-4427  
e-mail:  
[koreasales@powerint.com](mailto:koreasales@powerint.com)

#### UK (EUROPE & AFRICA HEADQUARTERS)

1st Floor, St. James's House  
East Street  
Farnham, Surrey GU9 7TJ  
United Kingdom  
Phone: +44-1252-730-140  
Fax: +44-1252-727-689  
e-mail: [eurosales@powerint.com](mailto:eurosales@powerint.com)

#### CHINA (SHENZHEN)

Rm# 1705, Bao Hua Bldg.  
1016 Hua Qiang Bei Lu,  
Shenzhen, Guangdong,  
518031, China  
Phone: +86-755-8367-5143  
Fax: +86-755-8377-9610  
e-mail:  
[chinasales@powerint.com](mailto:chinasales@powerint.com)

#### ITALY

Via Vittorio Veneto 12, Bresso,  
Milano,  
20091, Italy  
Phone: +39-028-928-6001  
Fax: +39-028-928-6009  
e-mail: [eurosales@powerint.com](mailto:eurosales@powerint.com)

#### SINGAPORE

51 Newton Road,  
#15-08/10 Goldhill Plaza,  
Singapore, 308900  
Phone: +65-6358-2160  
Fax: +65-6358-2015  
e-mail:  
[singaporesales@powerint.com](mailto:singaporesales@powerint.com)

#### APPLICATIONS HOTLINE

World Wide +1-408-414-9660

#### APPLICATIONS FAX

World Wide +1-408-414-9760

ER or EPR template – Rev 3.6 – Single sided

