

SHINDENGEN

Schottky Rectifiers (SBD)

Single

D1NS4

40V 1A

FEATURES

- Tj150
- P_{RRSM} avalanche guaranteed
- 5 mm pitch mounting applicable

APPLICATION

- Switching power supply
- DC/DC converter
- Home Appliances, Office Equipment
- Telecommunication

OUTLINE DIMENSIONS

Case : AX057

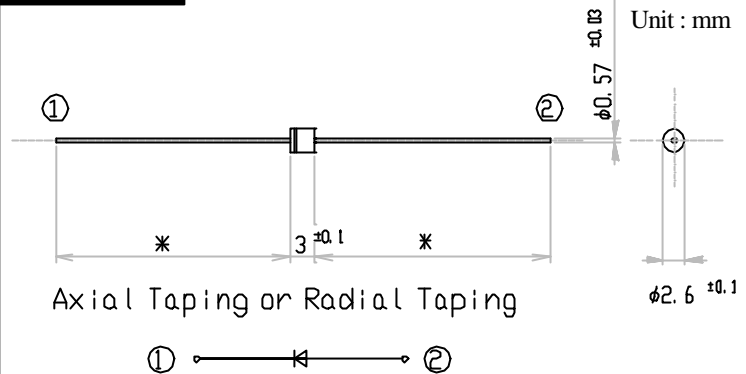

- *Taping Code No.4000:20^{MIN}
- No.4060:27^{MIN}
- No.4070:15^{MIN}

RATINGS

Absolute Maximum Ratings (If not specified Tl=25)

Item	Symbol	Conditions	Ratings	Unit
Storage Temperature	T _{stg}		-55 ~ 150	
Operating Junction Temperature	T _j		150	
Maximum Reverse Voltage	V _{RM}		40	V
Repetitive Peak Surge Reverse Voltage	V _{RRSM}	Pulse width 0.5ms, duty 1/40	45	V
Average Rectified Forward Current	I _o	50Hz sine wave, T _a =59	1	A
Peak Surge Forward Current	I _{FSM}	50Hz sine wave, Non-repetitive 1 cycle peak value, T _j =125	30	A
Repetitive Peak Surge Reverse Power	P _{RRSM}	Pulse width 10 μs, T _j =25	60	W

Electrical Characteristics (If not specified Tl=25)

Item	Symbol	Conditions	Ratings	Unit
Forward Voltage	V _F	I _F =1A, Pulse measurement	Max.0.55	V
Reverse Current	I _R	V _R =40V, Pulse measurement	Max.0.8	mA
Junction Capacitance	C _j	f=1MHz, V _R =10V	Typ.50	pF
Thermal Resistance	j-l	junction to lead	Max.10	/W
	j-a	junction to ambient, On P.C.B.	Max.113	

D1NS4

Forward Voltage

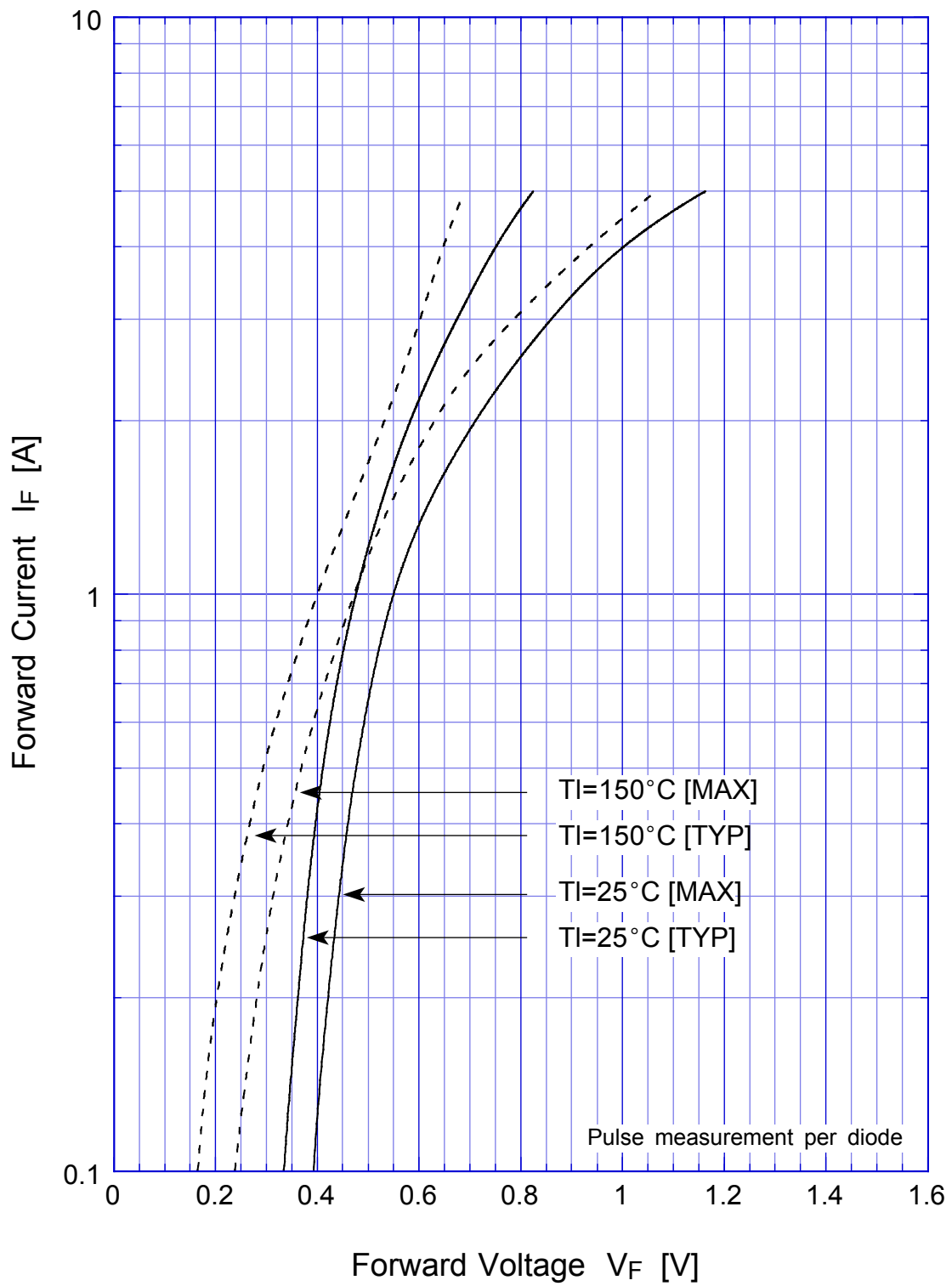

D1NS4

Junction Capacitance

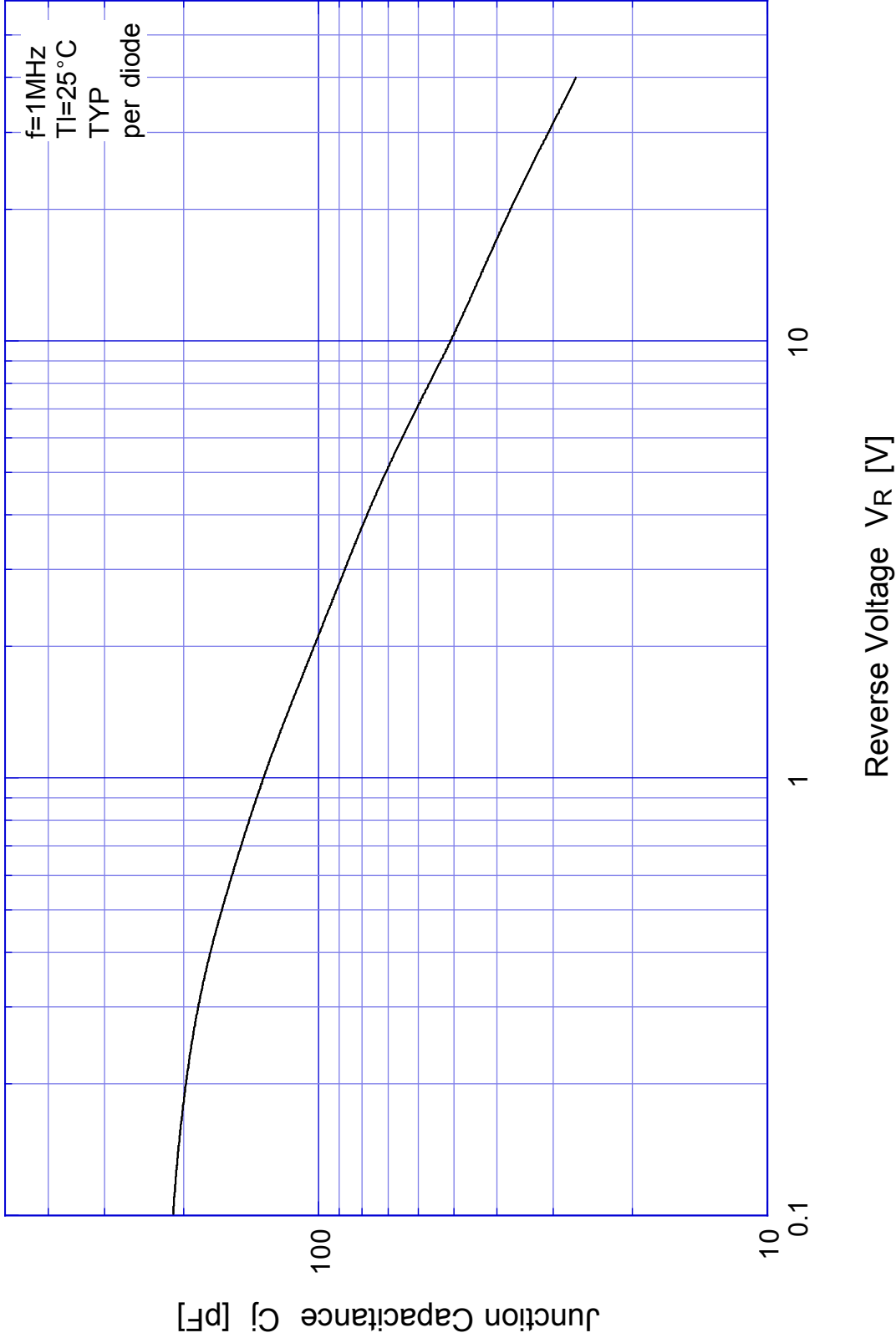

D1NS4

Reverse Current

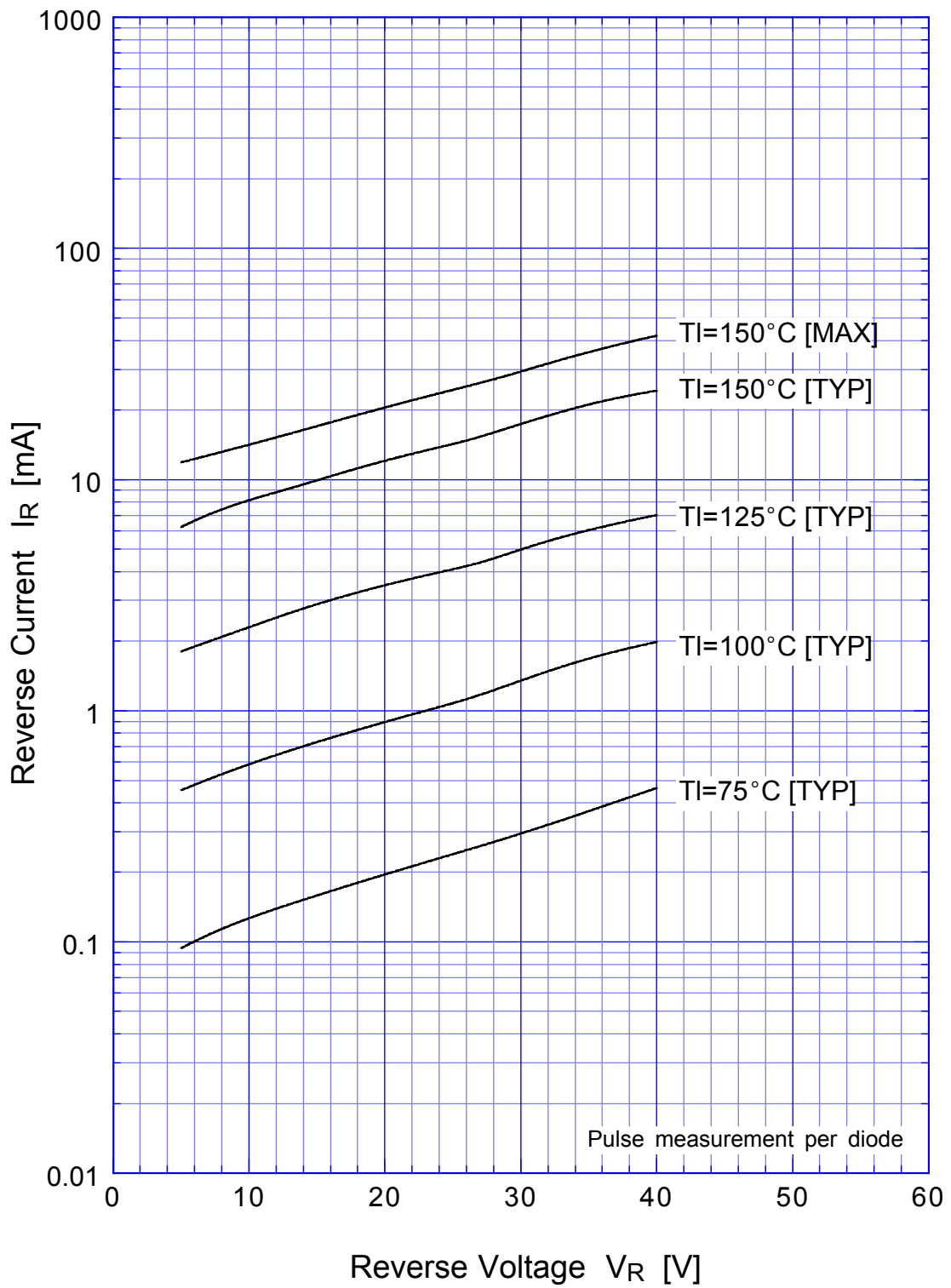

D1NS4

Reverse Power Dissipation

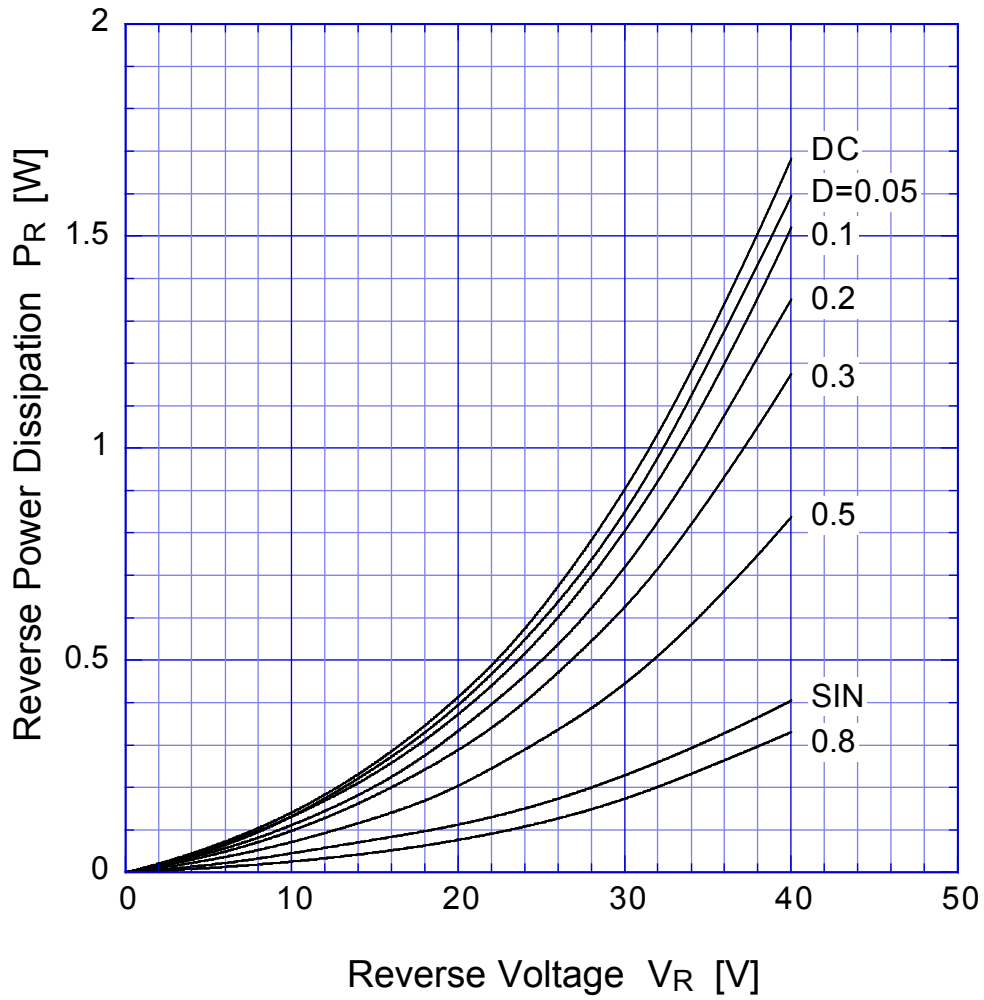

$T_j = 150^\circ\text{C}$

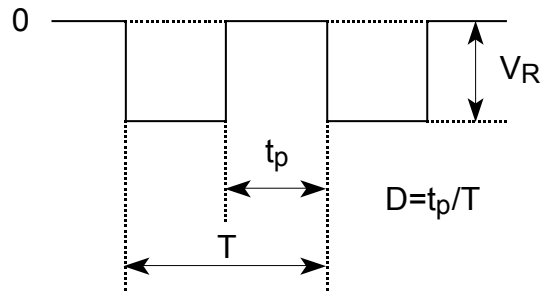

D1NS4

Forward Power Dissipation

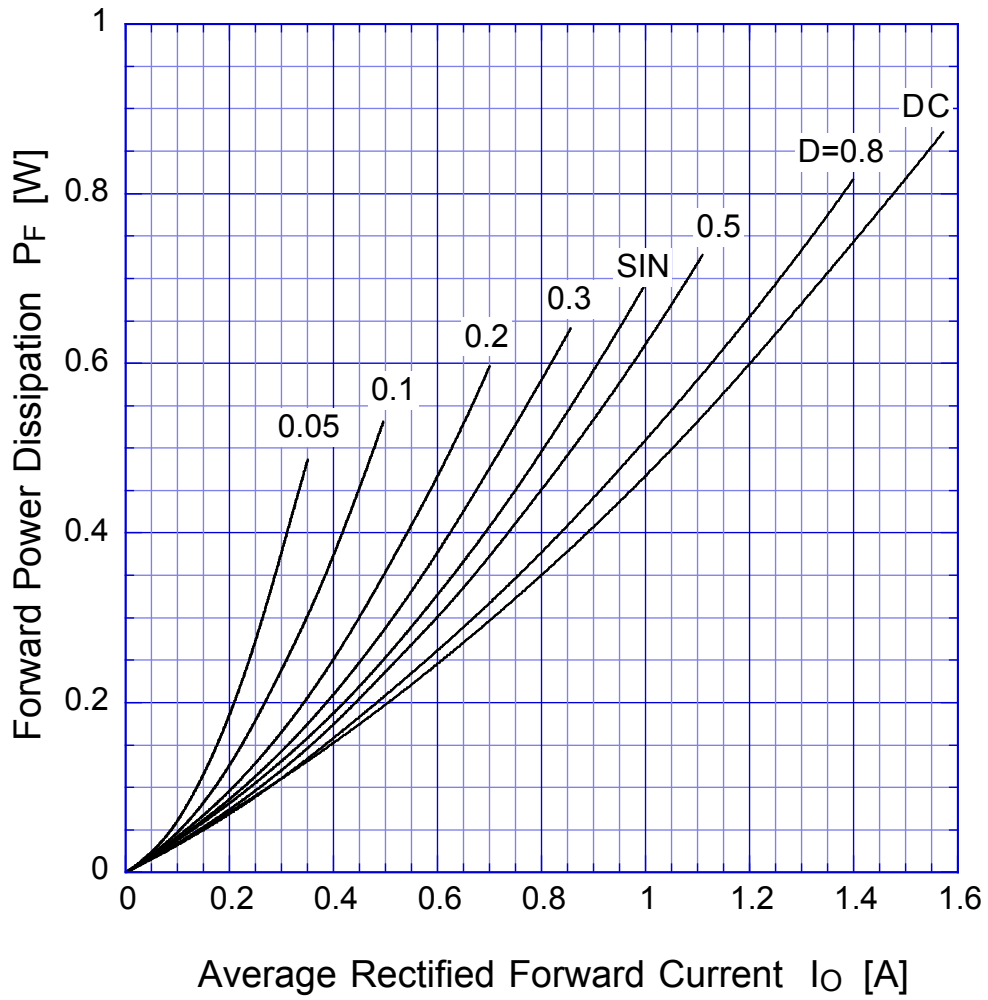

$T_j = 150^\circ\text{C}$

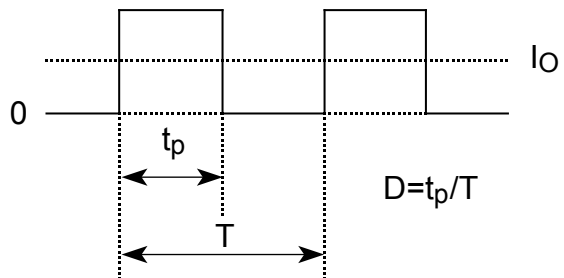

D1NS4

Derating Curve

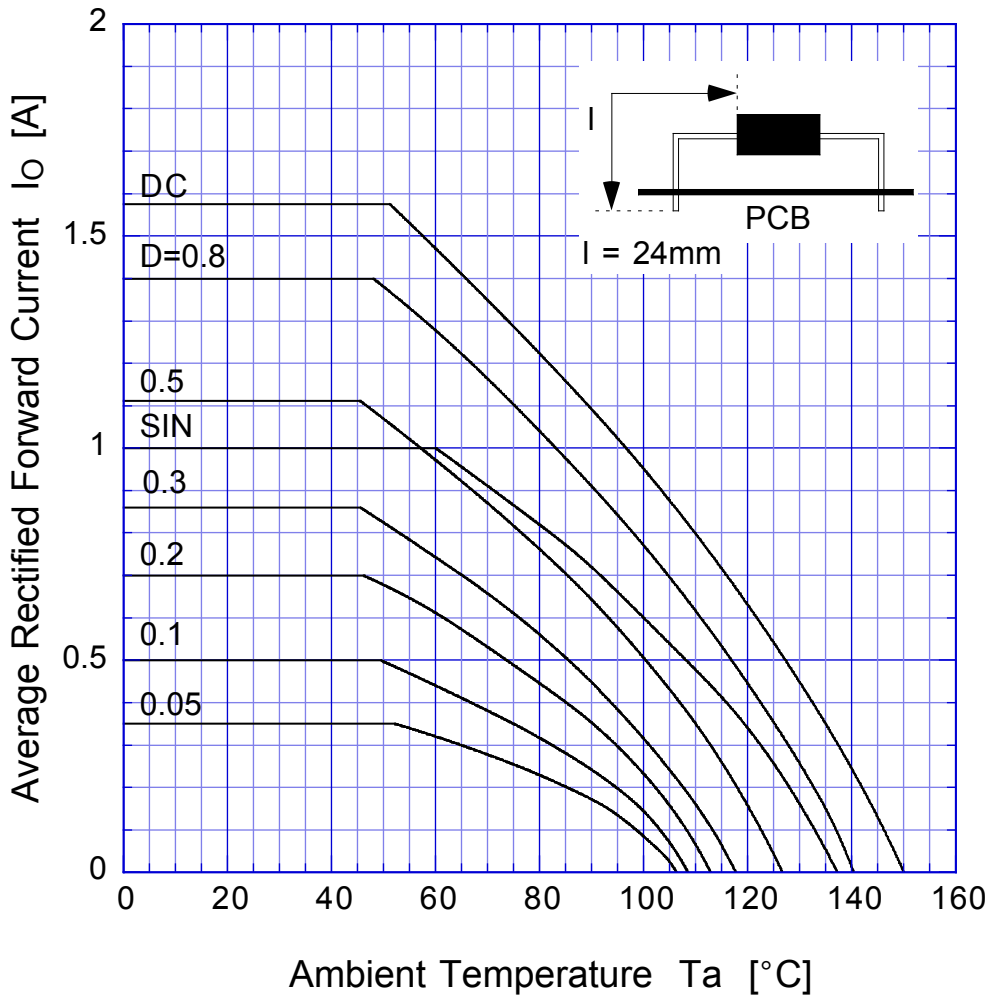

$V_R = 20\text{V}$



D1NS4

Peak Surge Forward Capability

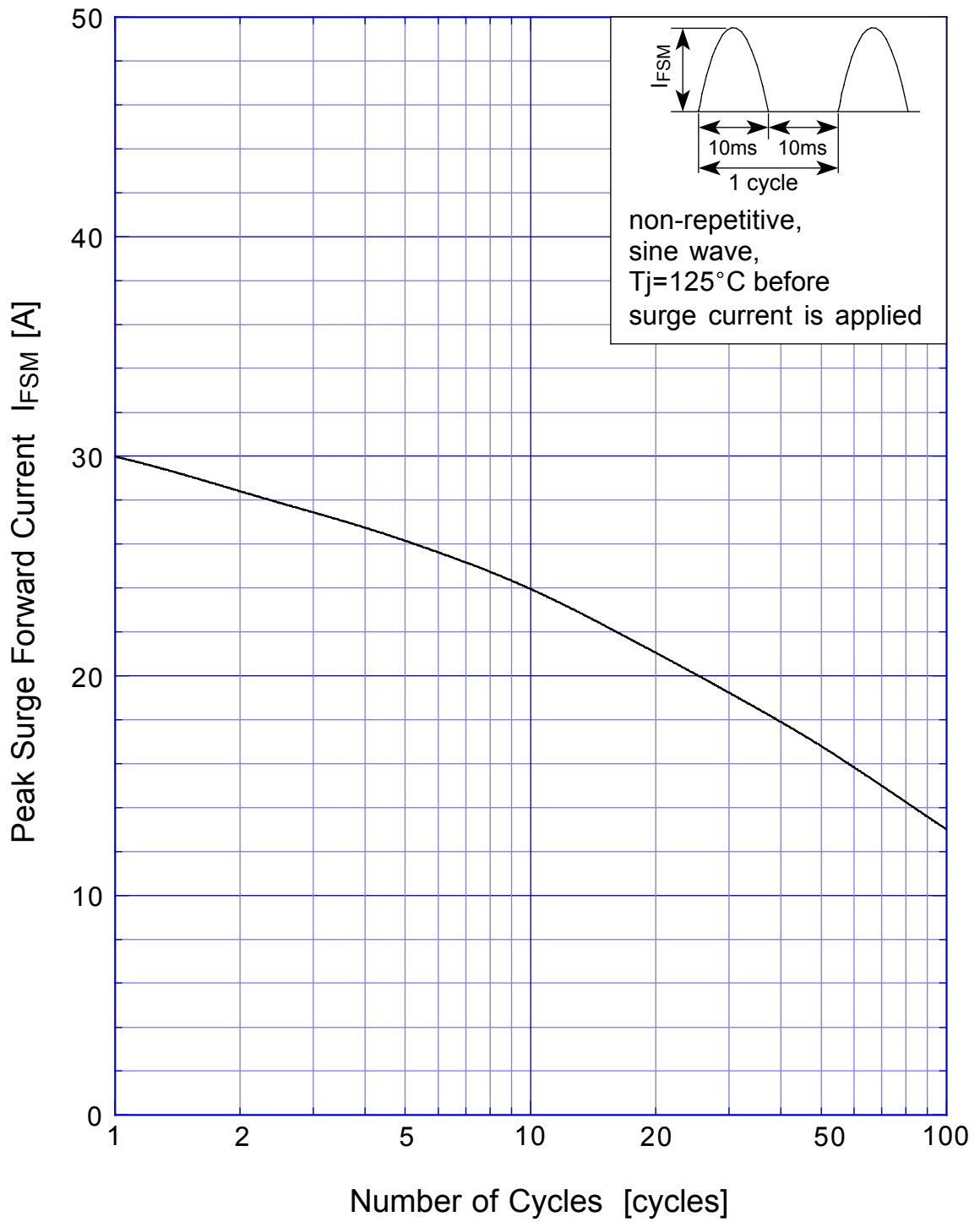

SBD Repetitive Surge Reverse Power Derating Curve

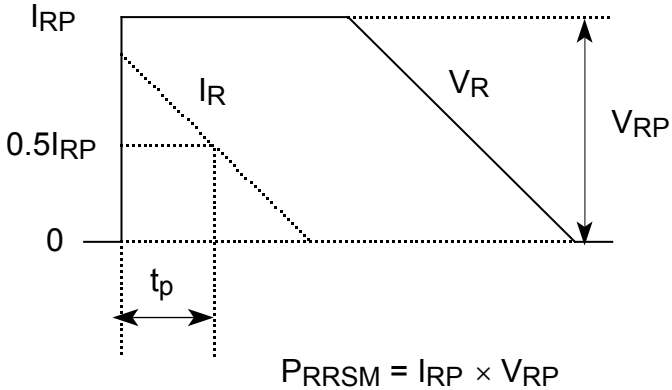
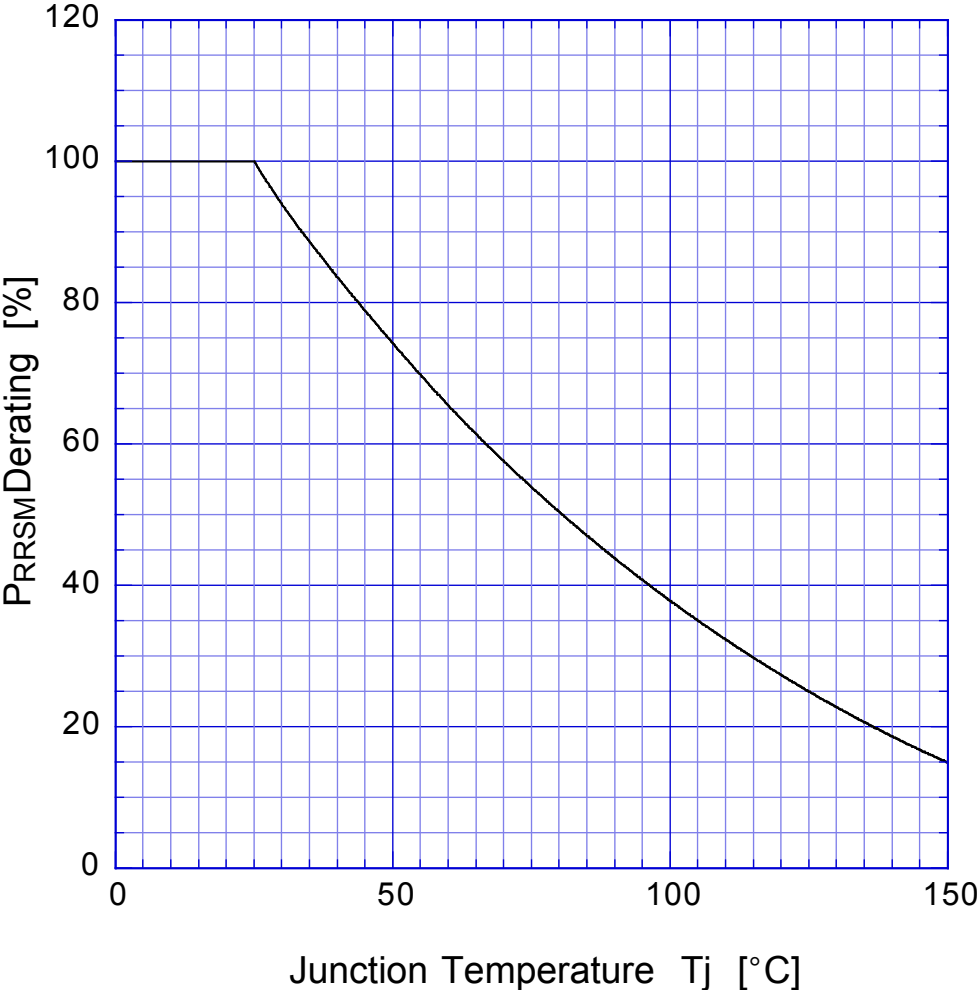

SBD

Repetitive Surge Reverse Power Capability

