

## Dual USB Overcurrent Switch 1.2A ( $V_{CC}$ ) / 200mA ( $V_{SBY}$ )

### Features

- Dual outputs, each with independent over-current protection circuitry and indicator
- Supports standby mode in PCs so that a peripheral can ramp down safely to a current <100mA
- Up to 1.2A ( $V_{CC}$ ) / 200mA ( $V_{SBY}$ ) continuous current on each output
- Over-current limits at 1.2A / 200mA respectively
- 10msec min fault blanking delay on OC# outputs prevents false overcurrent alarms
- Prevents backdrive current when host powered off
- Low operating current (95 $\mu$ A typ.)
- Small 8-Lead SOIC package

### Applications

- PC motherboards, Notebooks, Set-Top-Boxes

The CM3511 also prevents backdrive current flowing into the host from the connected peripheral. This can occur when  $V_{CC}$  is removed as the host powers down, and the peripheral still has normal power applied. The 5V from the peripheral can therefore be linked to the host's  $V_{BUS}$ , potentially causing backdrive current into the host and overloading the peripheral power supply.

### Pin Diagram

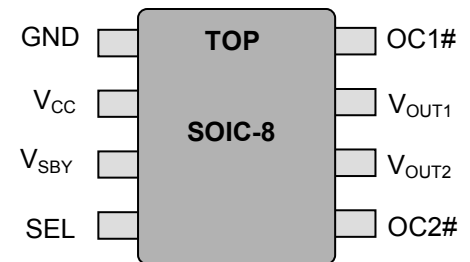

### Product Description

California Micro Devices' CM3511 is a dual port USB overcurrent power switch that selects between two independent 5V inputs available on a PC, depending on the state of a logic input (SEL). The device has two pairs of power switches, and each pair is an analog "OR" function, providing a continuous voltage at both outputs during power transfer between inputs.

$V_{CC}$  is the main 5V supply, which can be disabled in a PC, and  $V_{SBY}$  is the 5V standby supply which is powered up whenever the PC has power. When the 'SEL' pin is at logic high,  $V_{CC}$  is the assigned input power supply. When 'SEL' is at logic low,  $V_{SBY}$  is used to power the output, and no current is taken from  $V_{CC}$ . Both switches can be deselected and switched off by not driving (floating) the 'SEL' input, which places the chip in low power mode.

Both pairs of switches have over-current protection. Depending on whether 'SEL' is high or low, a current over 1.2A or 200mA respectively out of either output causes the device to enter a constant-current mode, where the output voltage is progressively reduced to prevent the current from increasing further. Each output is independent of the other, so if one of the switches is switched on but is not in overcurrent mode then it will remain switched on. The OC# output becomes active only if the overcurrent condition exceeds a minimum continuous duration of 10ms.

If the overcurrent condition is severe enough that the part heats up to the thermal limit  $T_{MAX}$ , the switch turns off and the temperature cools down to  $T_{MIN}$ . The switch then turns on again, and the device heats up again, and so on, until the fault is removed.

### Typical Application Circuit

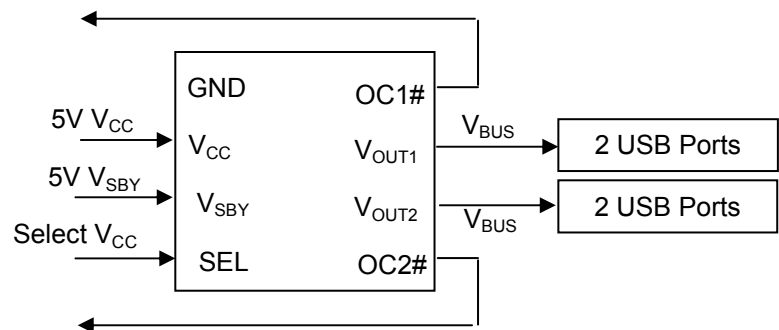

### Simplified Electrical Schematic

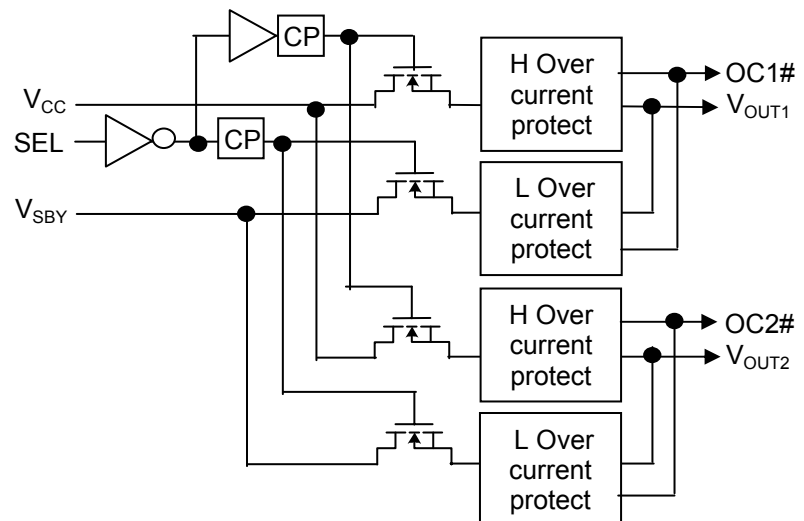



Absolute Maximum Ratings		
Parameter	Rating	Unit
ESD Protection (All pins, HBM)	± 2000	V
V <sub>CC</sub> , V <sub>SBY</sub> Input Voltage	+ 5.6, GND - 0.5	V
Storage Temperature Range	-55 to +150	°C
Operating Ambient	-40 to +85	
Operating Junction	-40 to +150*	
Output Current Loading	Internally limited	A
Package Power Dissipation	0.5	W

\* - Internally limited

Operating Conditions (unless specified otherwise)		
Parameter	Range	Unit
V <sub>CC</sub> , V <sub>SBY</sub> Input Voltage	4.5 to 5.5	V
Ambient Temperature	-40 to +85	°C
I <sub>LOAD</sub> per port	V <sub>CC</sub> 0 to 1200 V <sub>SBY</sub> 0 to 200	mA

Electrical Operating Characteristics (over operating conditions unless specified otherwise)						
Symbol	Parameter	Conditions	MIN	TYP	MAX	UNIT
UVLO	V <sub>CC</sub> /V <sub>SBY</sub> voltage under which circuit locks out - will not operate			2.2	2.5	V
V <sub>OUT1</sub> , V <sub>OUT2</sub>	Output Voltage	I <sub>LOAD</sub> = 1000mA, V <sub>CC</sub> = 5.0V, SEL = 5V, T = 25°C	4.8			V
R <sub>SW1</sub>	V <sub>CC</sub> Switch ON-Resistance	I <sub>LOAD</sub> = 0 to 1200mA; V <sub>CC</sub> = 5V T = 25°C		0.13	0.20	Ω
R <sub>SW2</sub>	V <sub>SBY</sub> Switch ON-Resistance	I <sub>LOAD</sub> = 0 to 200mA; V <sub>SBY</sub> = 5V T = 25°C		0.7	1.4	Ω
I <sub>LIM VCC</sub>	V <sub>CC</sub> over-current limit	V <sub>CC</sub> = 5V SEL = high	1200			mA
I <sub>LIM VSBY</sub>	V <sub>SBY</sub> over-current limit	V <sub>SBY</sub> = 5V SEL = low	200			mA
t <sub>FBD</sub>	Time delay from overcurrent detection to OC# output indication (fault blanking delay)		10	20		ms
T <sub>MAX</sub>	Temperature at which hot switch turns off during overcurrent			150		°C
T <sub>MIN</sub>	Temperature at which cool switch turns on, after cooling from T <sub>MAX</sub>			125		°C
I <sub>R CC</sub> I <sub>R SBY</sub>	Reverse leakage from outputs to inputs – backdrive current	V <sub>CC</sub> = 0V, V <sub>OUT</sub> = 5V, SEL floating V <sub>SBY</sub> = 0V, V <sub>OUT</sub> = 5V, SEL floating		1 1		μA
I <sub>CC ON</sub>	V <sub>CC</sub> operating supply current	V <sub>CC</sub> = 5V, V <sub>SBY</sub> < V <sub>CC</sub> , SEL = high, I <sub>LOAD</sub> = 0mA		95		μA
I <sub>SBY OFF</sub>	V <sub>SBY</sub> standby supply current			1		μA
I <sub>SBY ON</sub>	V <sub>SBY</sub> operating supply current	V <sub>SBY</sub> = 5V, V <sub>SBY</sub> > V <sub>CC</sub> , SEL = low, I <sub>LOAD</sub> = 0mA		95		μA
I <sub>CC OFF</sub>	V <sub>CC</sub> standby supply current			1		μA
I <sub>CC HQ</sub>	V <sub>CC</sub> higher, quiescent current			40		μA
I <sub>SBY LQ</sub>	V <sub>SBY</sub> lower, quiescent current	V <sub>CC</sub> = 5V, V <sub>SBY</sub> < V <sub>CC</sub> , SEL floating		1		μA
I <sub>CC LQ</sub>	V <sub>CC</sub> lower, quiescent current			1		μA
I <sub>SBY HQ</sub>	V <sub>SBY</sub> higher, quiescent current	V <sub>CC</sub> = 5V, V <sub>SBY</sub> > V <sub>CC</sub> , SEL floating		40		μA
V <sub>IH-EN</sub>	EN# input Logic-1 threshold	V <sub>CC</sub> = 5V	2			V
V <sub>IL-EN</sub>	EN# input Logic-0 threshold	V <sub>CC</sub> = 5V			0.8	V
I <sub>OHZ-OC</sub>	OC# output OFF state leakage	V <sub>CC</sub> = 5V, V <sub>OUT</sub> = 5V			1.0	uA
V <sub>OL-OC</sub>	OC# output Logic-0 threshold	I <sub>OC</sub> = 1mA to V <sub>CC</sub>			0.4	V

Note: the internal supply current is taken from whichever input (V<sub>CC</sub> or V<sub>SBY</sub>) is higher.



**Pin Functions**

**V<sub>CC</sub>** is the higher current power source. Whenever the SEL pin is above 2V it will be selected, and V<sub>SBY</sub> will be deselected.

**V<sub>SBY</sub>** is the lower current power source. Whenever the SEL pin is below 0.8V it will be selected, and V<sub>CC</sub> will be deselected. The two V<sub>SBY</sub> power switches can only supply 200mA each.

Note that the internal supply current (95uA typ.) will be taken from whichever input supply pin (V<sub>CC</sub> or V<sub>SBY</sub>) is higher.

**V<sub>OUT1</sub>** provides the power for a USB port. The internal MOSFET switches are designed for low voltage drops from the voltage input pins at their full rated currents.

**V<sub>OUT2</sub>** provides the power for a second USB port. The internal MOSFET switches are designed for low voltage drops from the voltage input pins at their full rated currents.

Current loads of up to 1.2A are allowed (sourced from V<sub>CC</sub>).

Current loads above 1.2A may cause the constant-current limiting circuit to operate – reducing the output voltage.

Continuous over-current loads will cause the part's internal temperature to rise. If the internal temperature exceeds 150°C then any switch that is in overcurrent mode will be immediately turned off. Any switch that is not in overcurrent mode will remain on – it will not be affected by the over-temperature detection. Once the part has cooled to 125°C then the switch or switches that were in overcurrent mode will be automatically turned on again.

During the cold-start interval when the input is initially applied, internal circuitry provides a soft turn-on for the switches, which limits peak in-rush current.

**SEL** is the 3-level logic input pin that is used to control which of the power switch pairs are turned on. Set SEL high to select V<sub>CC</sub>, set SEL low to select V<sub>SBY</sub>, or allow SEL to float to deselect both power switches. The external device driving the SEL pin must be able to source and sink 100µA while maintaining the proper V<sub>IL</sub>/V<sub>IH</sub> levels.

**OC1#**, **OC2#** are independent, active low open-drain outputs, indicating an overcurrent fault condition has been detected at V<sub>OUT1</sub> or V<sub>OUT2</sub>. There is a built-in 10msec (min.) fault blanking period after the overcurrent fault condition has been detected, before these outputs become active. The OC# outputs become deasserted only when both the overcurrent condition stops and when the voltage drop across the switch is less than 1V. External pull-up resistors of 10k - 100k are required if the OC# outputs are used.

Because they are open-drain, the two OC# outputs can be shorted together to make one OC# signal.

**GND** is the negative reference for all voltages.

Pin Functions		
Pin No.	Symbol	Description
1	GND	Negative reference for all voltages.
2	V <sub>CC</sub>	High current positive supply input.
3	V <sub>SBY</sub>	Standby positive supply input. Also provides internal power.
4	SEL	3-level logic input. High = V <sub>CC</sub> , Low = V <sub>SBY</sub> , Floating = both off
5	OC2#	Active low when V <sub>OUT2</sub> is in overcurrent mode.
6	V <sub>OUT2</sub>	Output voltage internally switched to either V <sub>CC</sub> or V <sub>SBY</sub> input source.
7	V <sub>OUT1</sub>	Output voltage internally switched to either V <sub>CC</sub> or V <sub>SBY</sub> input source.
8	OC1#	Active low when V <sub>OUT1</sub> is in overcurrent mode.

STANDARD PART ORDERING INFORMATION			
Pins	Package	Ordering Part Number <sup>1</sup>	Part Marking
8	SOIC	CM3511-04SN	CM3511-04SN

© 2003 California Micro Devices Corp. All rights reserved



Note 1: Parts are shipped in Tape & Reel form unless otherwise specified.

### OC# Response to Momentary Overcurrent Fault

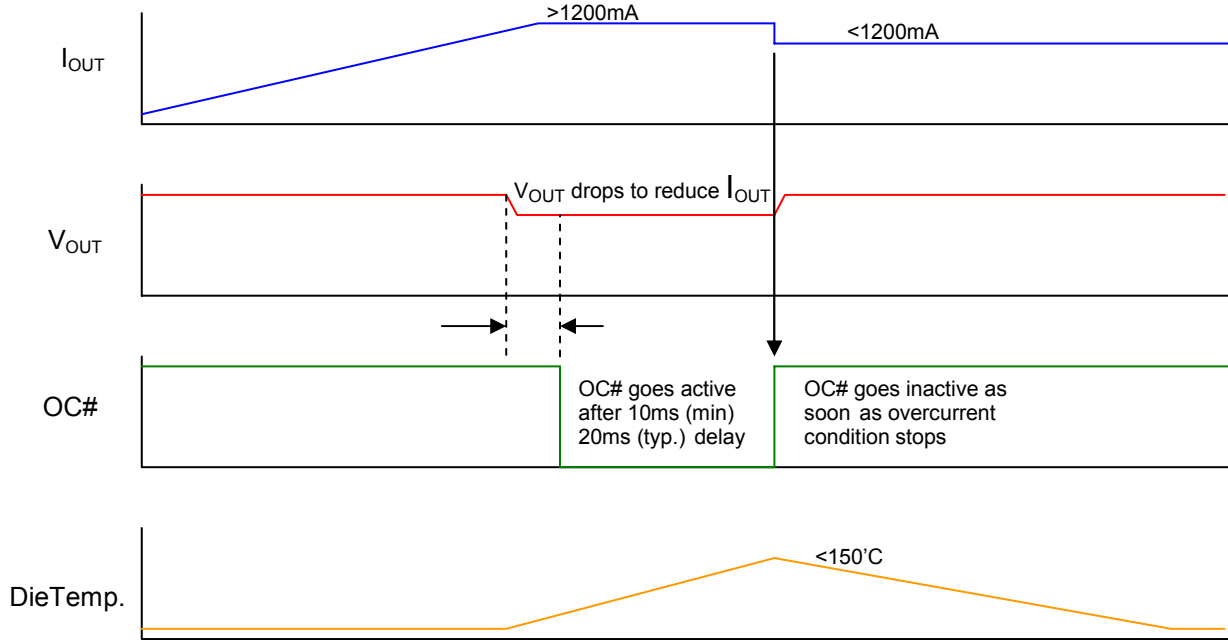

### OC# Response to Continuous Overcurrent Fault

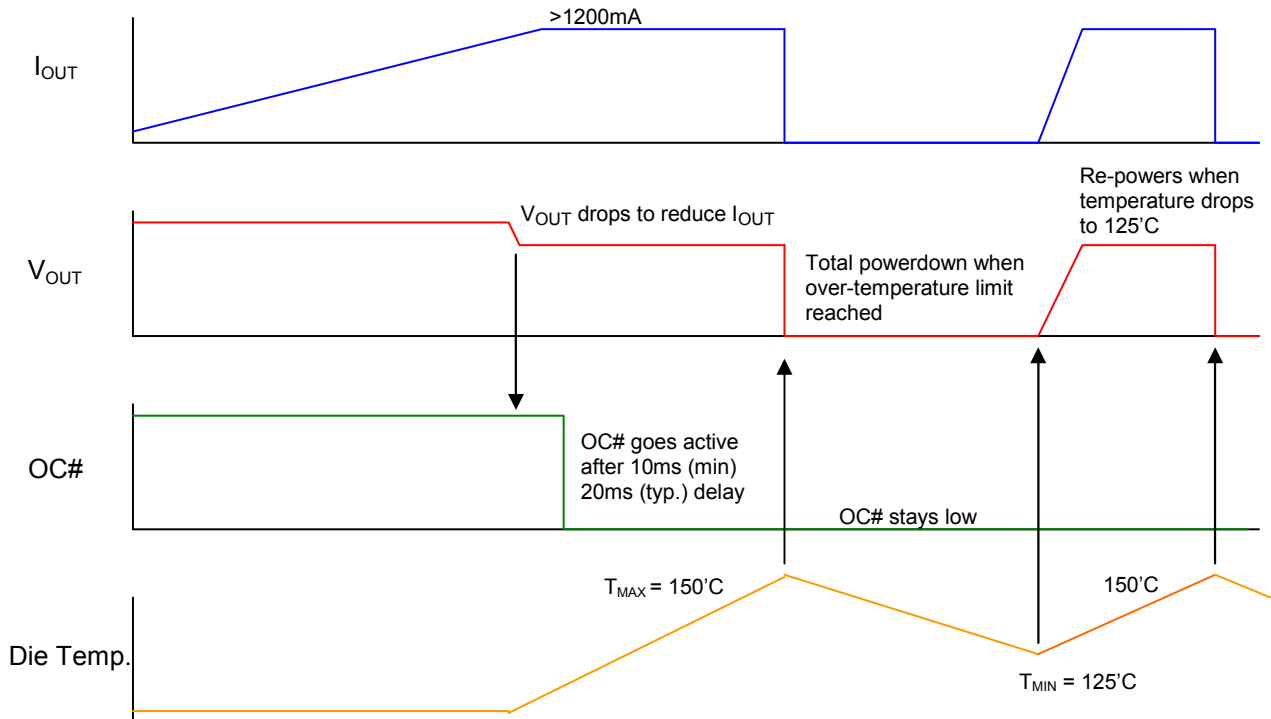

Note: The other port stays on (unless it is also in current limit.)



### Typical Operating Characteristics

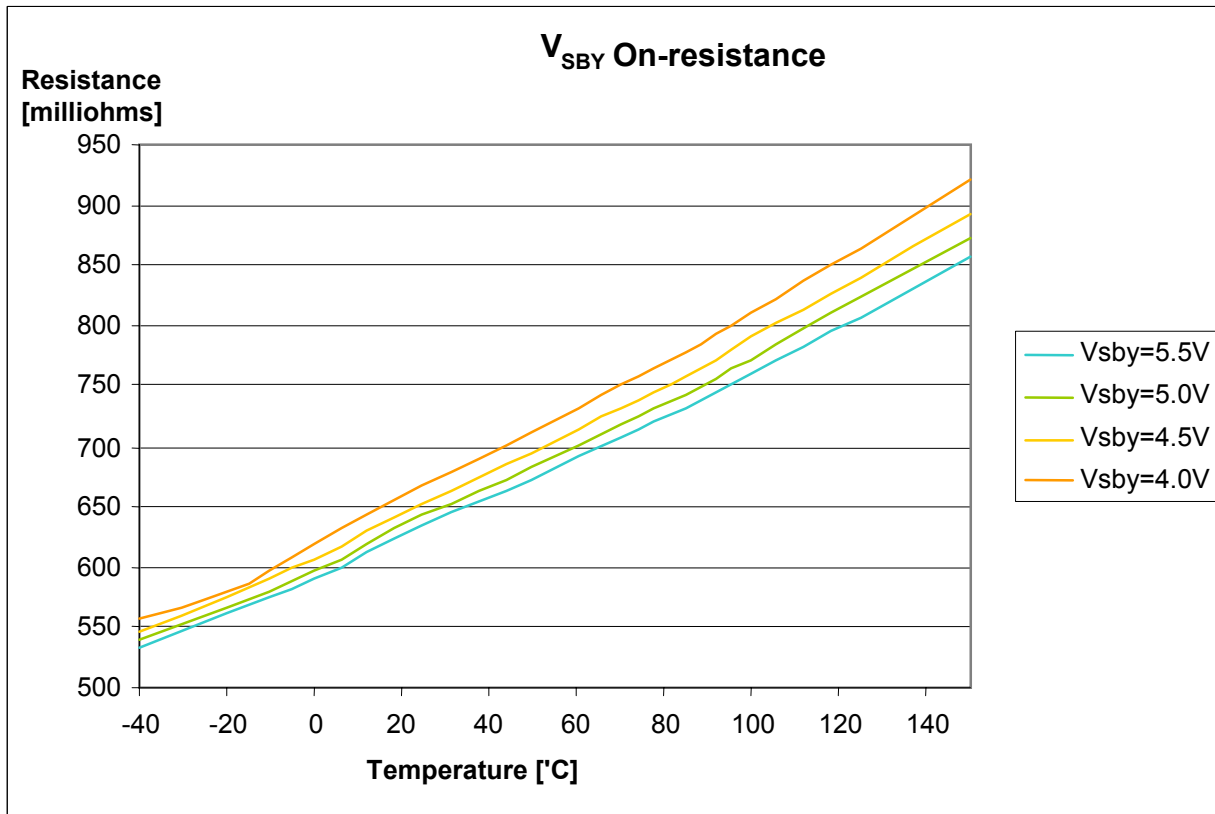
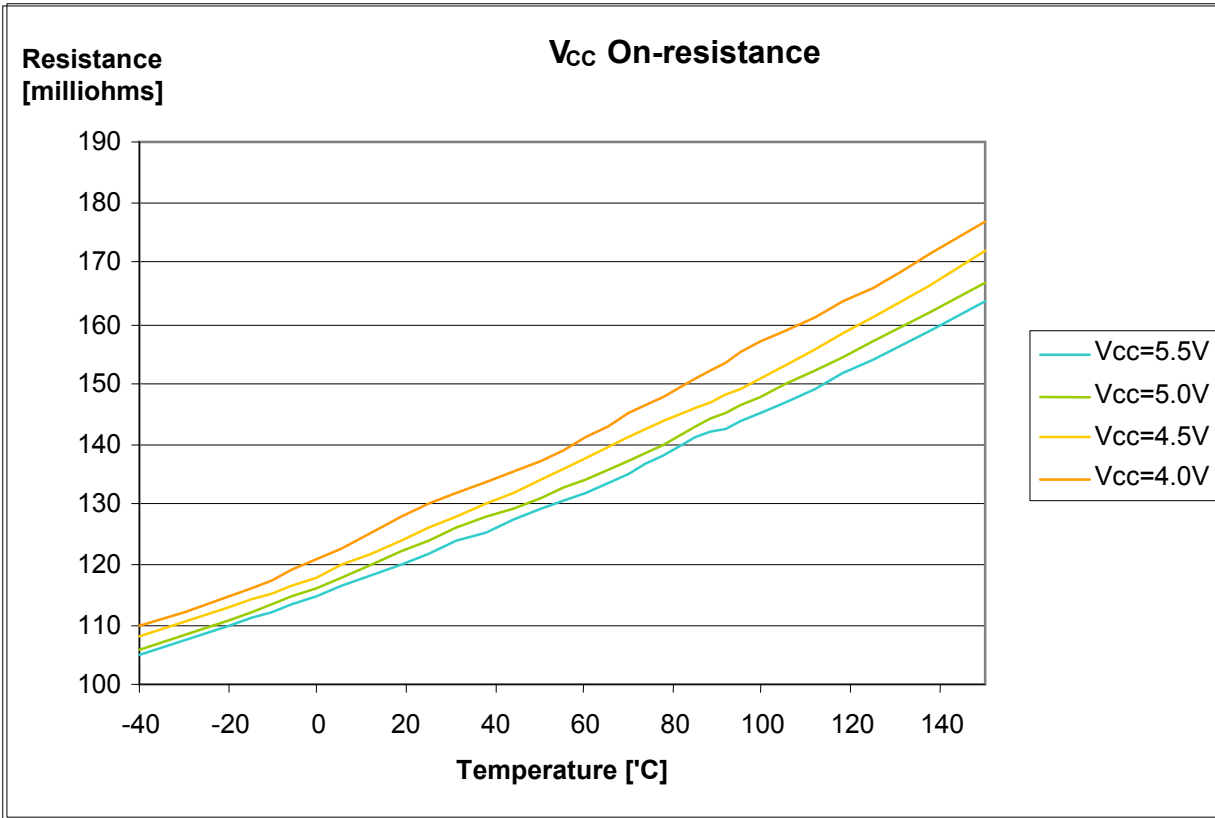

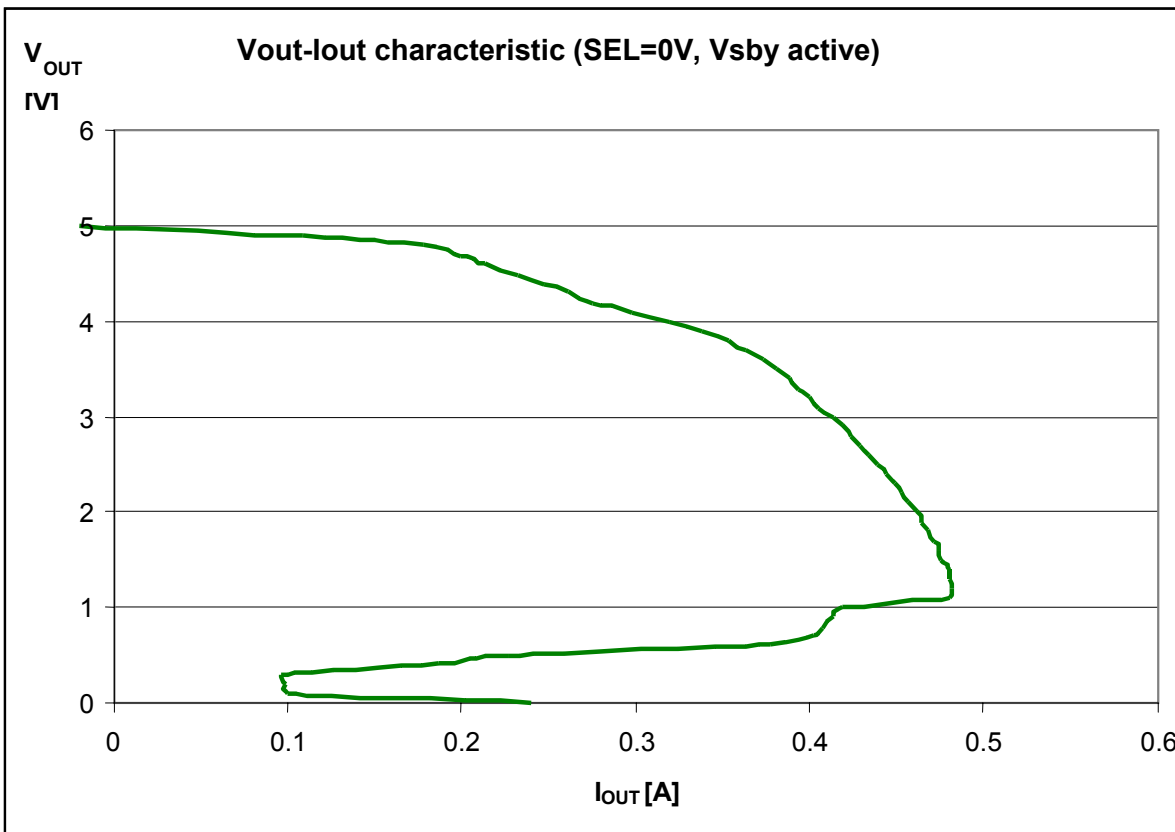
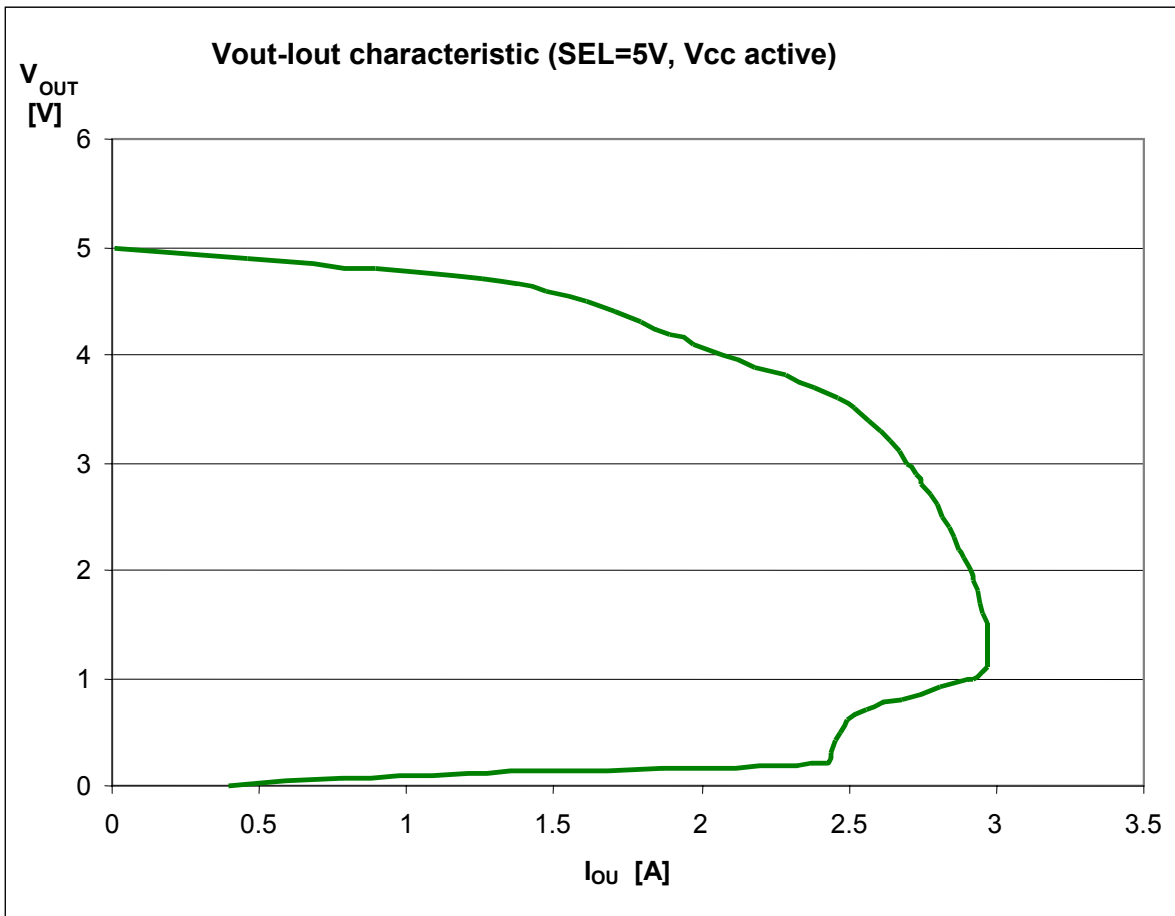

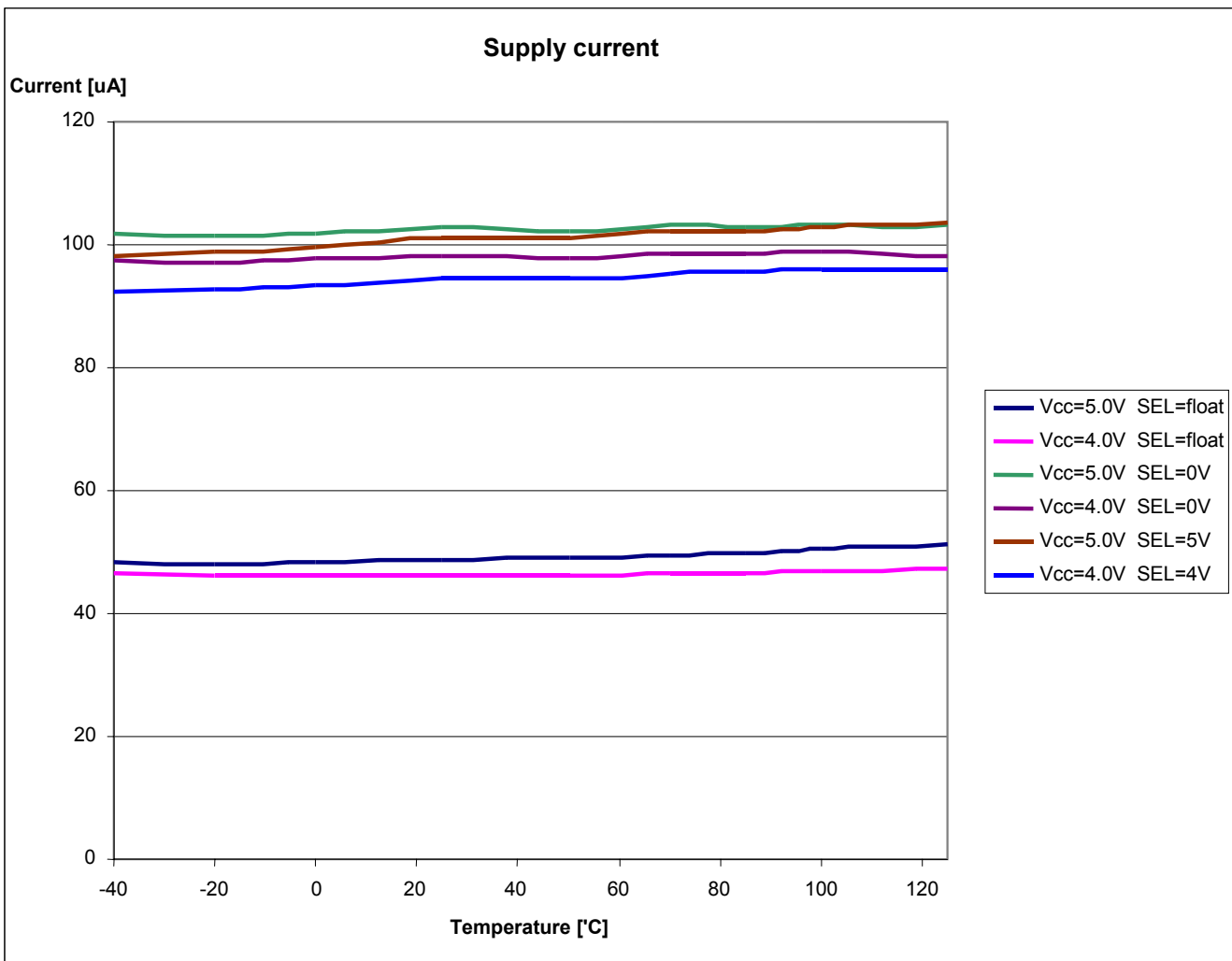
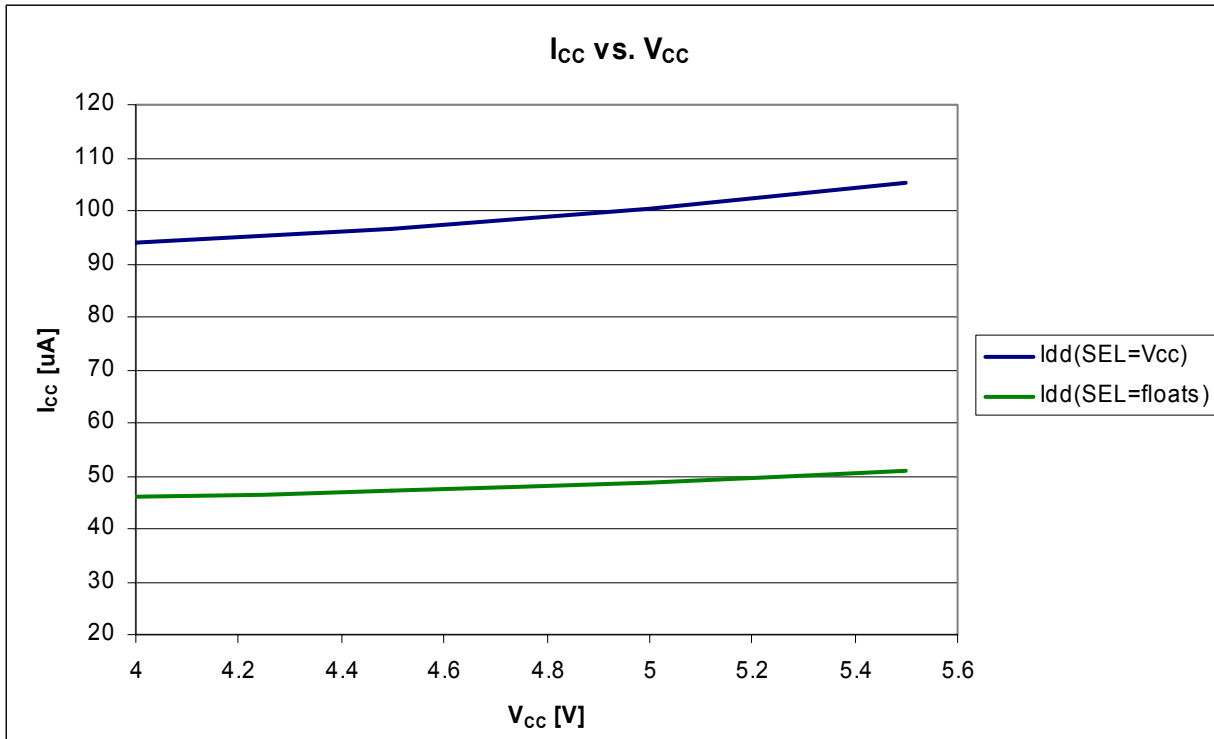

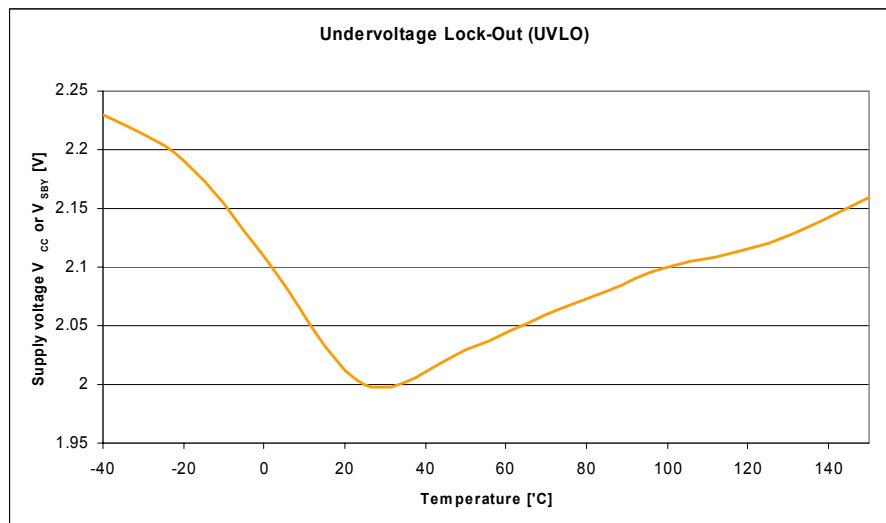
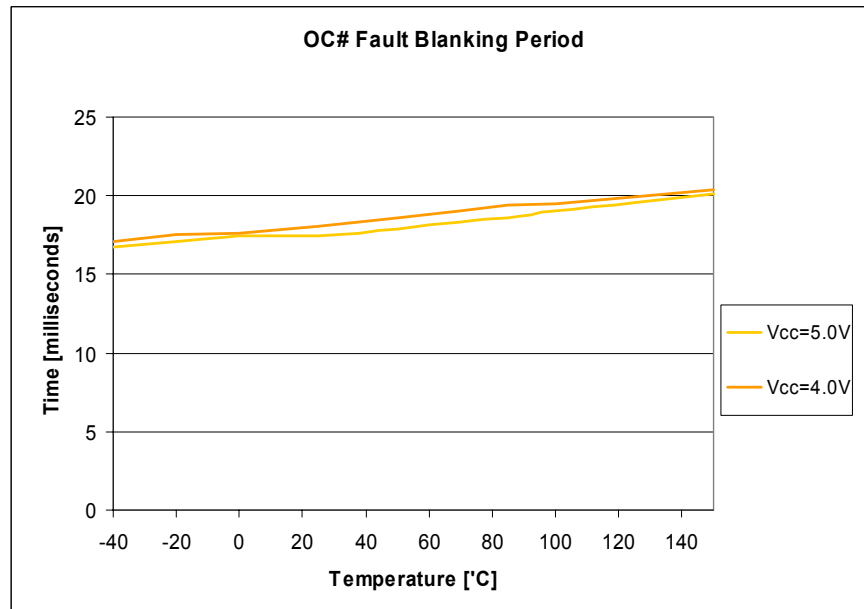
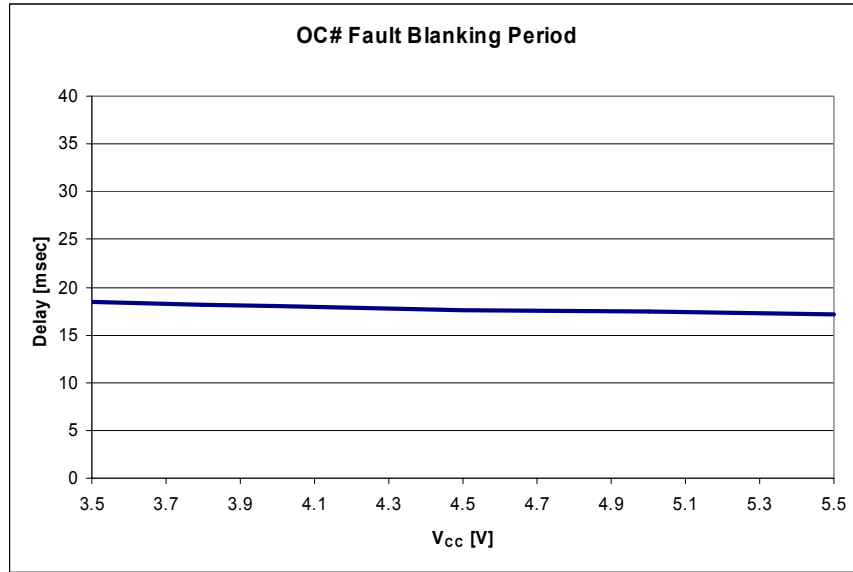



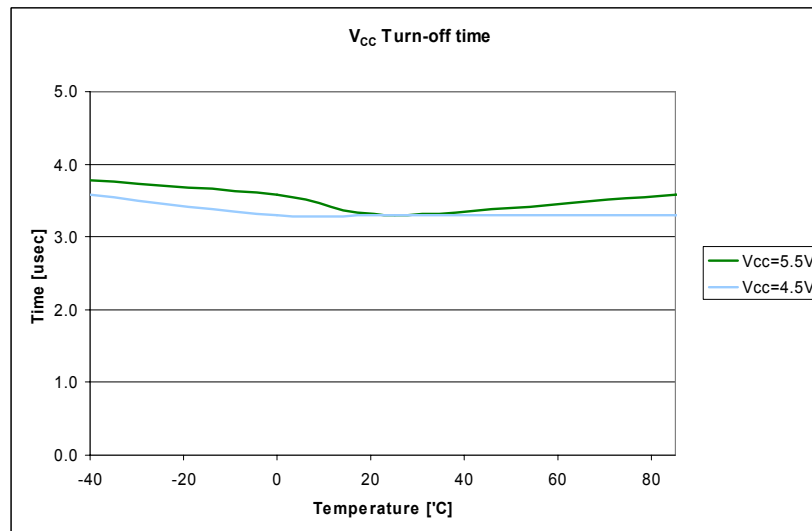
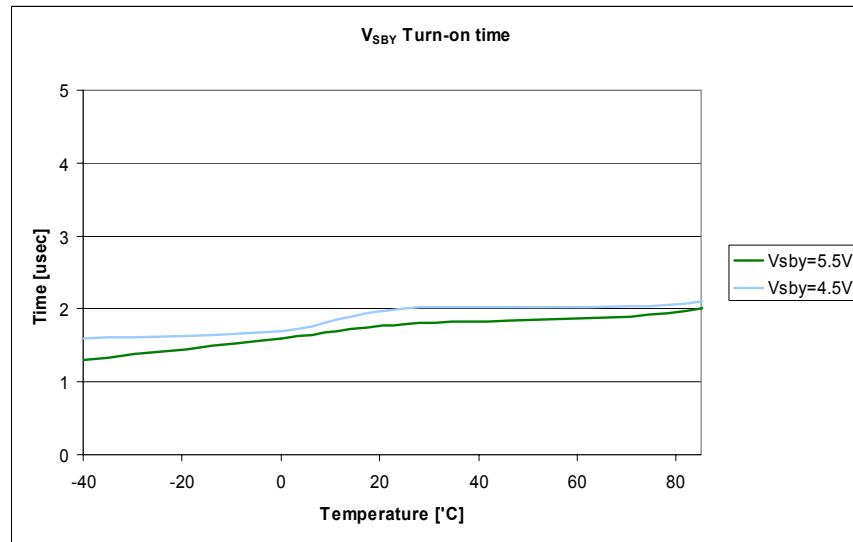
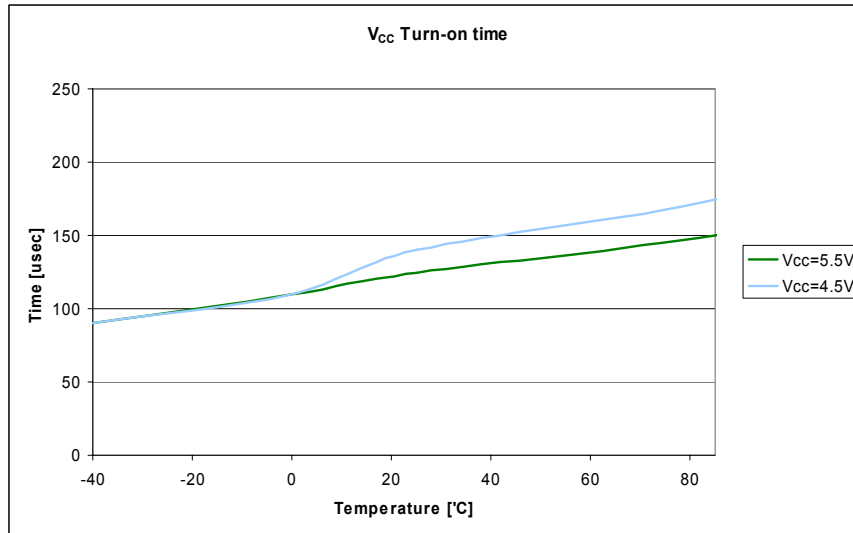

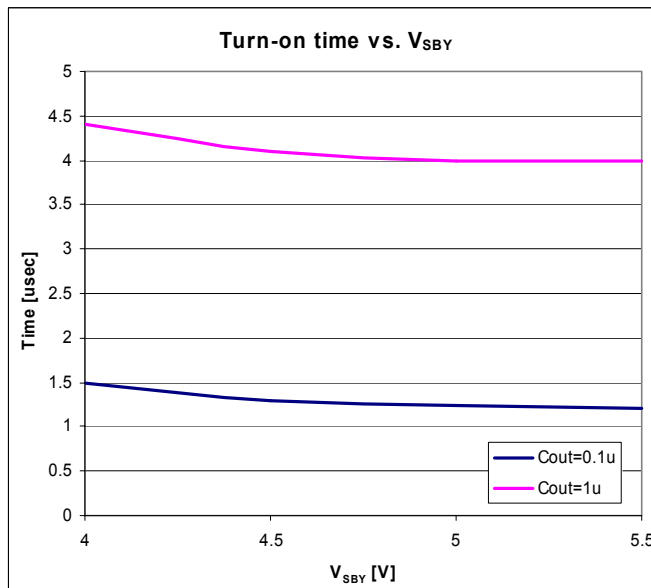
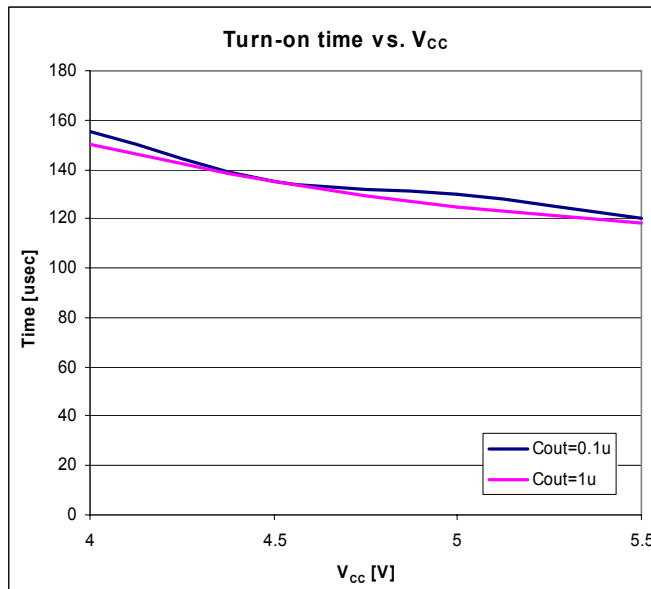
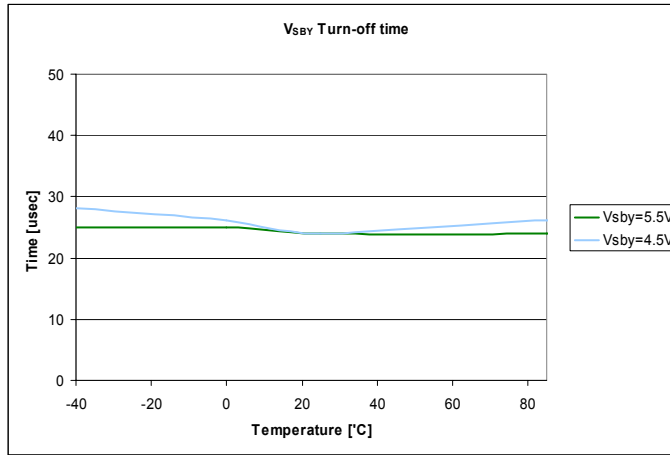

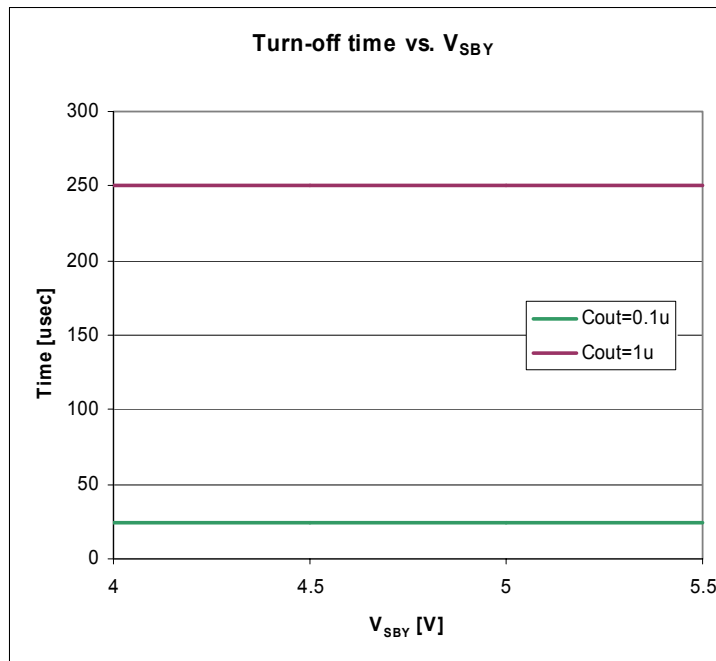
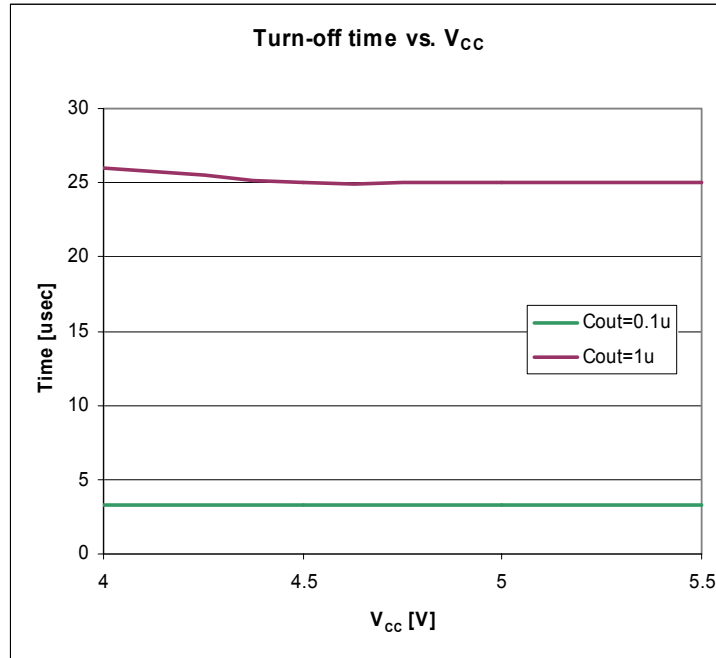

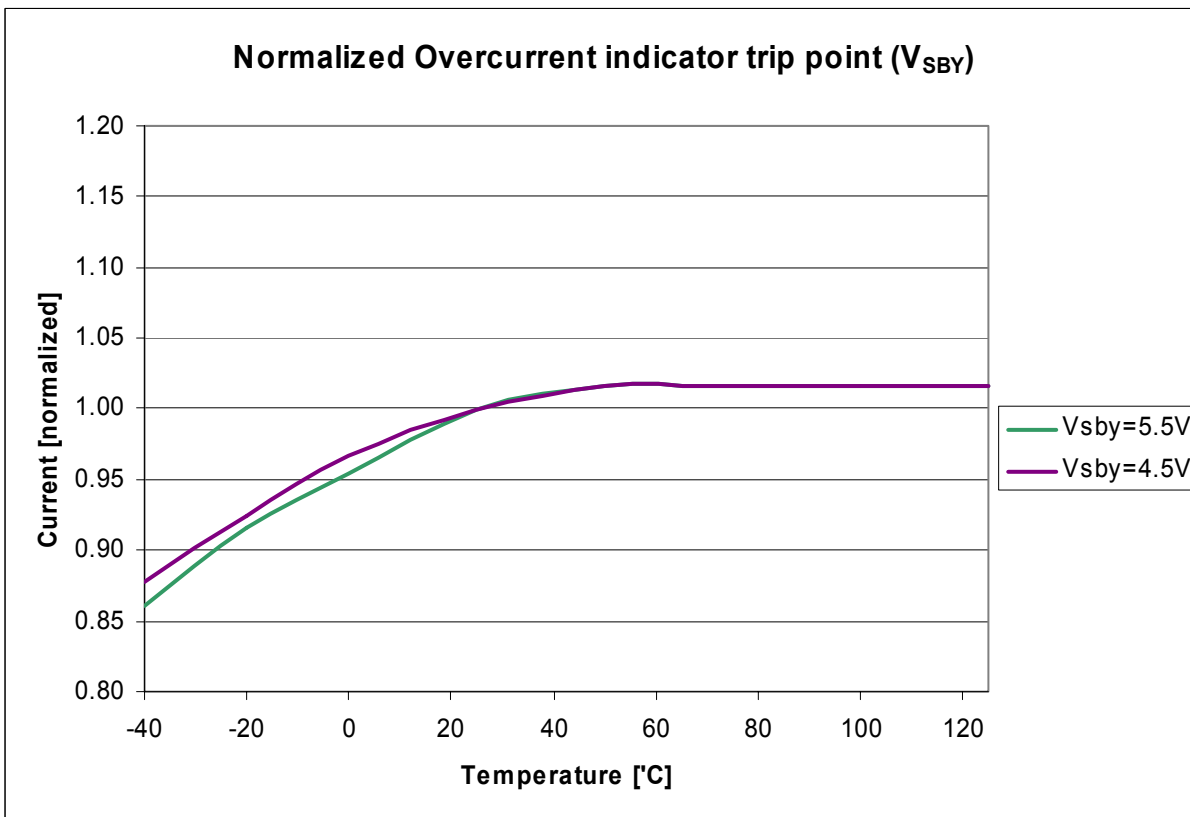
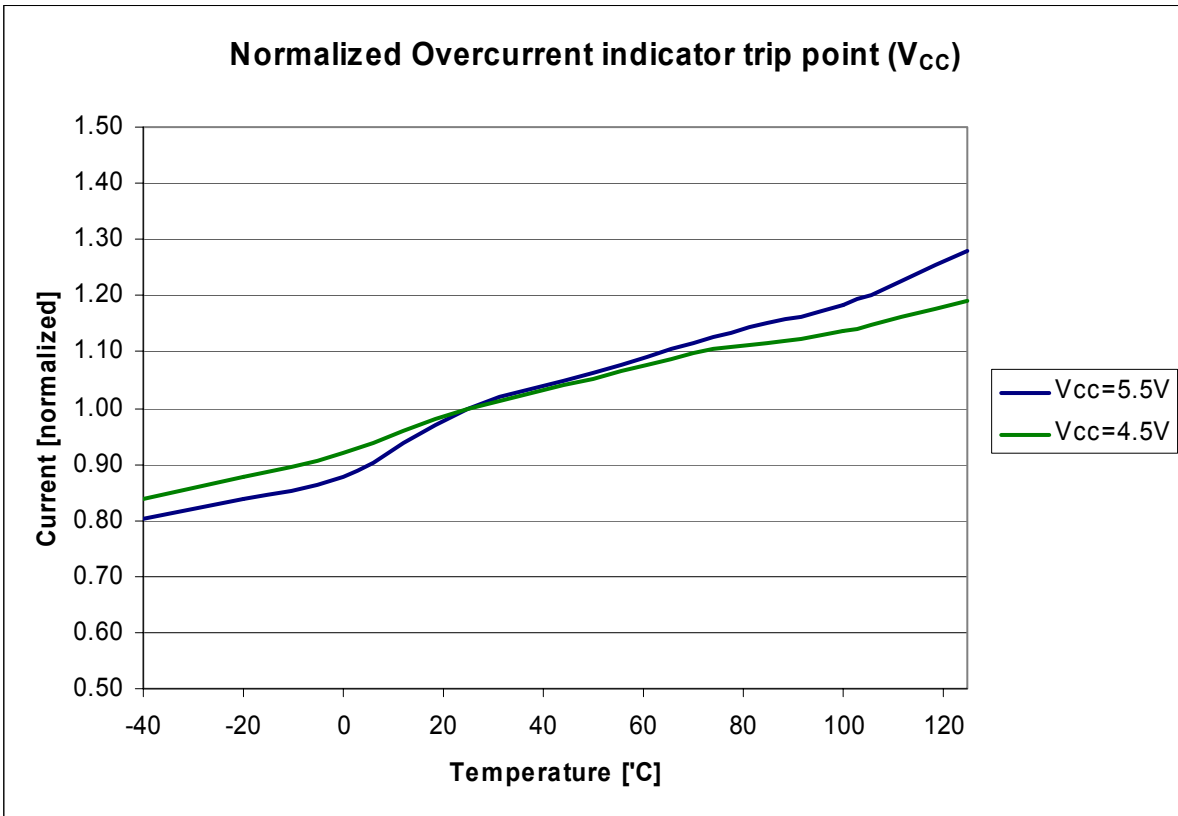



### SOIC-8 Package Dimensions

