

CEP6020P/CEB6020P

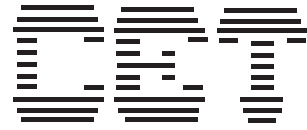

PRELIMINARY

4

Single P-Channel Enhancement Mode MOSFET

FEATURES

- -20V , -25A , $R_{DS(ON)}=55m\Omega$ @ $V_{GS}=-4.5V$
 $R_{DS(ON)}=155m\Omega$ @ $V_{GS}=-2.5V$
- Super high dense cell design for extremely low $R_{DS(ON)}$.
- High power and current handling capability.
- TO-220 & TO-263 package .

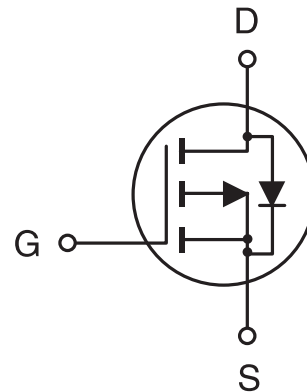

ABSOLUTE MAXIMUM RATINGS (Tc=25°C unless otherwise noted)

Parameter	Symbol	Limit	Unit
Drain-Source Voltage	V _{DS}	-20	V
Gate-Source Voltage	V _{GS}	±8	V
Drain Current-Continuous @T _J =125°C -Pulsed	I _D	-25	A
	I _{DM}	-70	A
Drain-Source Diode Forward Current	I _S	-25	A
Maximum Power Dissipation	P _D	60	W
Operating Junction and Storage Temperature Range	T _J , T _{STG}	-65 to 175	°C

THERMAL CHARACTERISTICS

Thermal Resistance, Junction-to-Ambient	R _{θJA}	62.5	°C/W
---	------------------	------	------

CEP6020P/CEB6020P

ELECTRICAL CHARACTERISTICS (Tc=25°C unless otherwise noted)

4

Parameter	Symbol	Condition	Min	Typ	Max	Unit
OFF CHARACTERISTICS						
Drain-Source Breakdown Voltage	BV _{DSS}	V _{GS} = 0V, I _D =-250μA	-20			V
Zero Gate Voltage Drain Current	I _{DSS}	V _{DS} =-16V, V _{GS} =0V			-1	μA
Gate-Body Leakage	I _{GSS}	V _{GS} = ±8V, V _{DS} = 0V			±100	nA
ON CHARACTERISTICS^a						
Gate Threshold Voltage	V _{GS(th)}	V _{DS} =V _{GS} , I _D = -250μA	-0.4		-1.0	V
Drain-Source On-State Resistance	R _{DS(ON)}	V _{GS} =-4.5V, I _D =-12A			55	mΩ
		V _{GS} =-2.5V, I _D =-6A			155	mΩ
On-State Drain Current	I _{D(ON)}	V _{DS} =-5V, V _{GS} =-4.5V	-24			A
Forward Transconductance	g _{FS}	V _{DS} =-5V, I _D =-12A	5			S
DYNAMIC CHARACTERISTICS^b						
Input Capacitance	C _{ISS}	V _{DS} = -10V, V _{GS} = 0V f = 1.0MHz			1750	pF
Output Capacitance	C _{OSS}				750	pF
Reverse Transfer Capacitance	C _{RSS}				250	pF
SWITCHING CHARACTERISTICS^b						
Turn-On Delay Time	t _{D(ON)}	V _{DD} = -20V, I _D = -3A, V _{GEN} = -5V, R _{GEN} = 8Ω			30	ns
Rise Time	t _r			11	60	ns
Turn-Off Delay Time	t _{D(OFF)}			23	250	ns
Fall time	t _f			14	150	ns
Total Gate Charge	Q _g	V _{DS} = -10V, I _D = -24A, V _{GS} = -5V		42		nC
Gate-Source Charge	Q _{gs}			7		nC
Gate-Drain Charge	Q _{gd}			5		nC

CEP6020P/CEB6020P

4

ELECTRICAL CHARACTERISTICS ($T_c=25^\circ\text{C}$ unless otherwise noted)

Parameter	Symbol	Condition	Min	Typ	Max	Unit
DRAIN-SOURCE DIODE CHARACTERISTICS^a						
Diode Forward Voltage	V_{SD}	$V_{GS} = 0V, I_s = -12A$			-1.3	V

Notes

- a. Pulse Test: Pulse Width $\leq 300 \mu\text{s}$, Duty Cycle $\leq 2\%$.
- b. Guaranteed by design, not subject to production testing.

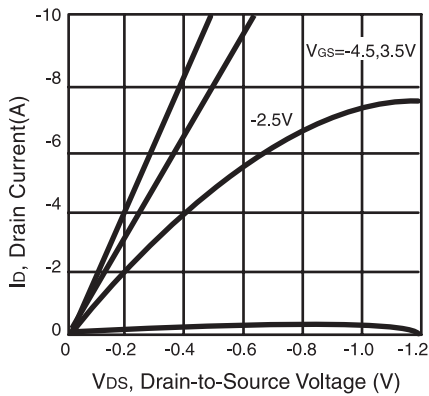

Figure 1. Output Characteristics

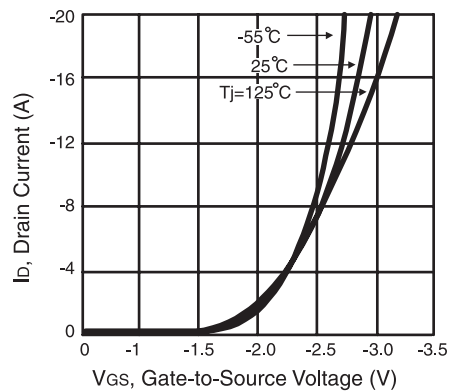

Figure 2. Transfer Characteristics

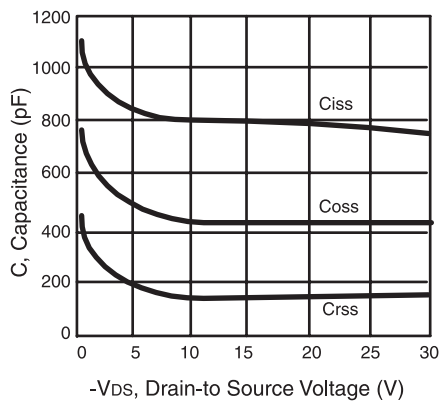

Figure 3. Capacitance

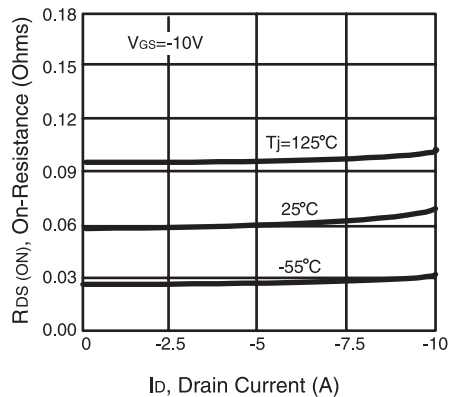

Figure 4. On-Resistance Variation with Drain Current and Temperature

CEP6020P/CEB6020P

4

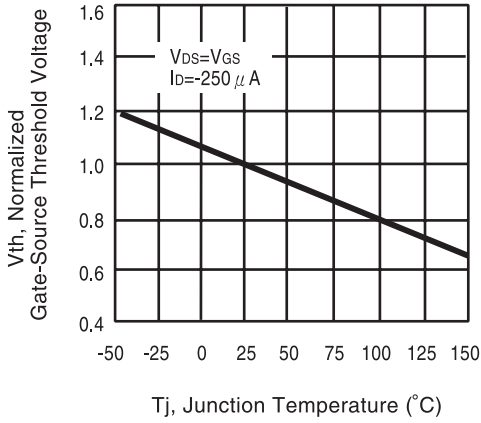

Figure 5. Gate Threshold Variation with Temperature

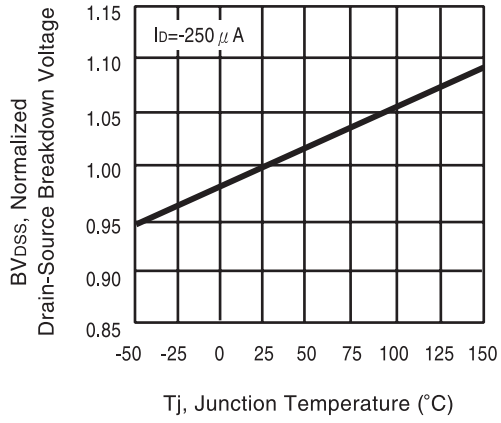

Figure 6. Breakdown Voltage Variation with Temperature

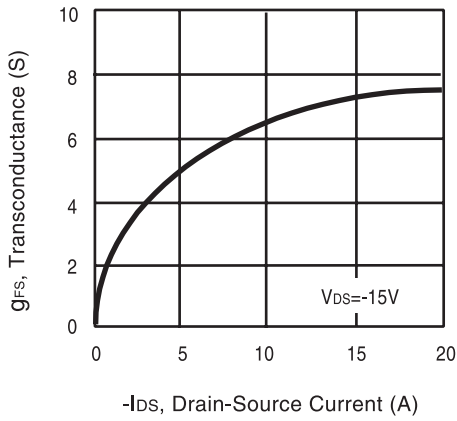

Figure 7. Transconductance Variation with Drain Current

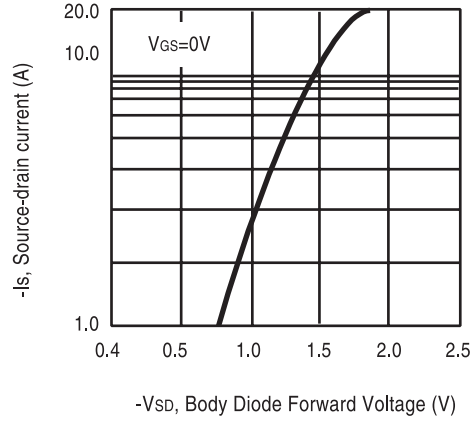

Figure 8. Body Diode Forward Voltage Variation with Source Current

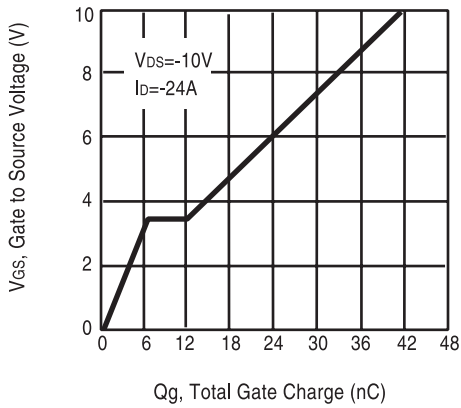

Figure 9. Gate Charge

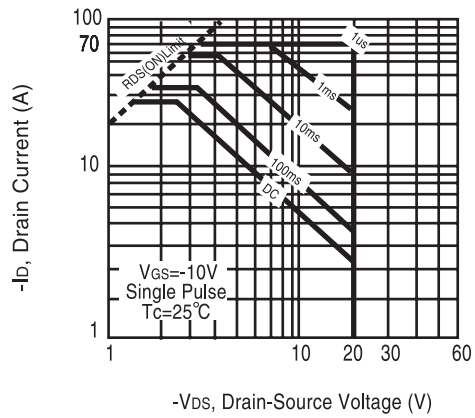

Figure 10. Maximum Safe Operating Area

CEP6020P/CEB6020P

4

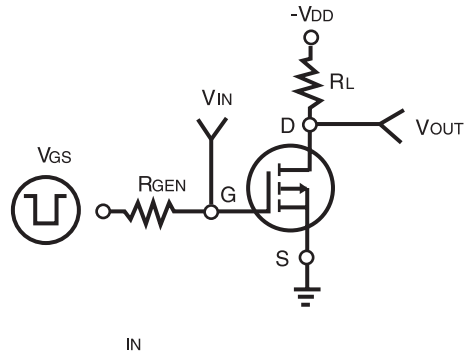

Figure 11. Switching Test Circuit

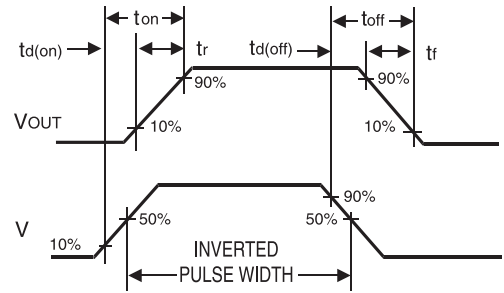

Figure 12. Switching Waveforms

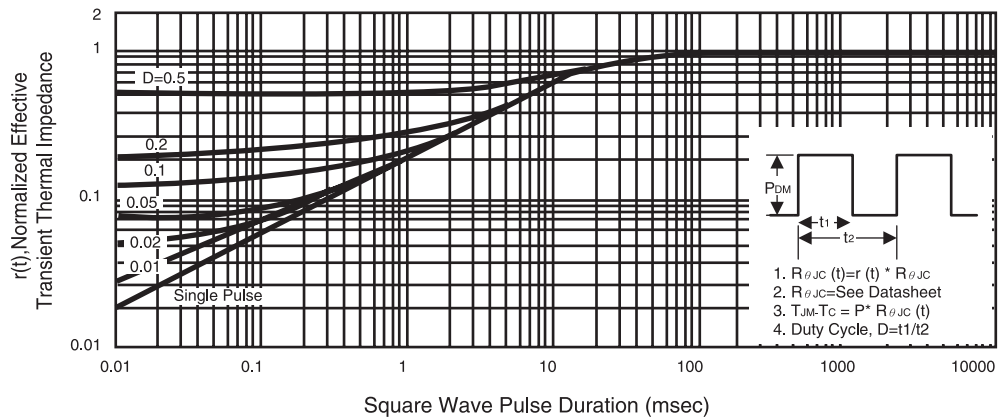

Figure 13. Normalized Thermal Transient Impedance Curve