

## BSP 373

### SIPMOS<sup>®</sup> Small-Signal Transistor

- N channel
- Enhancement mode
- Avalanche rated
- $V_{GS(th)} = 2.1 \dots 4.0 \text{ V}$

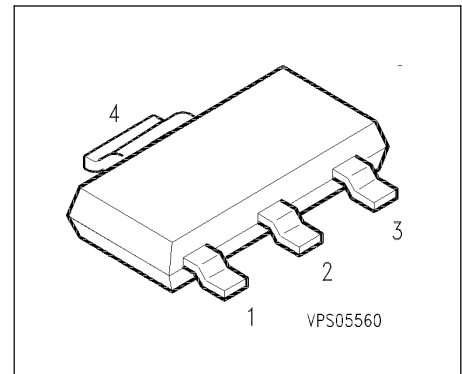

Pin 1	Pin 2	Pin 3	Pin 4
G	D	S	D

Type	$V_{DS}$	$I_D$	$R_{DS(on)}$	Package	Marking
BSP 373	100 V	1.7 A	0.3 $\Omega$	SOT-223	BSP 373

Type	Ordering Code	Tape and Reel Information
BSP 373	Q67000-S301	E6327

### Maximum Ratings

Parameter	Symbol	Values	Unit
Continuous drain current $T_A = 28 \text{ }^\circ\text{C}$	$I_D$	1.7	A
DC drain current, pulsed $T_A = 25 \text{ }^\circ\text{C}$	$I_{Dpuls}$	6.8	
Avalanche energy, single pulse $I_D = 1.7 \text{ A}$ , $V_{DD} = 25 \text{ V}$ , $R_{GS} = 25 \text{ } \Omega$ $L = 23.3 \text{ mH}$ , $T_j = 25 \text{ }^\circ\text{C}$	$E_{AS}$	45	mJ
Gate source voltage	$V_{GS}$	$\pm 20$	V
Power dissipation $T_A = 25 \text{ }^\circ\text{C}$	$P_{tot}$	1.8	W

**Maximum Ratings**

Parameter	Symbol	Values	Unit
Chip or operating temperature	$T_j$	-55 ... + 150	°C
Storage temperature	$T_{stg}$	-55 ... + 150	
Thermal resistance, chip to ambient air	$R_{thJA}$	≤ 70	K/W
Thermal resistance, junction-soldering point <sup>1)</sup>	$R_{thJS}$	≤ 10	
DIN humidity category, DIN 40 040		E	
IEC climatic category, DIN IEC 68-1		55 / 150 / 56	

1) Transistor on epoxy pcb 40 mm x 40 mm x 1,5 mm with 6 cm<sup>2</sup> copper area for drain connection

**Electrical Characteristics, at  $T_j = 25^\circ\text{C}$ , unless otherwise specified**

Parameter	Symbol	Values			Unit
		min.	typ.	max.	

**Static Characteristics**

Drain- source breakdown voltage $V_{GS} = 0\text{ V}, I_D = 0.25\text{ mA}, T_j = 0^\circ\text{C}$	$V_{(BR)DSS}$	100	-	-	V
Gate threshold voltage $V_{GS} = V_{DS}, I_D = 1\text{ mA}$	$V_{GS(th)}$	2.1	3	4	
Zero gate voltage drain current $V_{DS} = 100\text{ V}, V_{GS} = 0\text{ V}, T_j = 25^\circ\text{C}$ $V_{DS} = 100\text{ V}, V_{GS} = 0\text{ V}, T_j = 125^\circ\text{C}$	$I_{DSS}$	-	0.1 10	1 100	μA
Gate-source leakage current $V_{GS} = 20\text{ V}, V_{DS} = 0\text{ V}$	$I_{GSS}$	-	10	100	
Drain-Source on-state resistance $V_{GS} = 10\text{ V}, I_D = 1.7\text{ A}$	$R_{DS(on)}$	-	0.16	0.3	Ω

**Electrical Characteristics, at  $T_j = 25^\circ\text{C}$ , unless otherwise specified**

Parameter	Symbol	Values			Unit
		min.	typ.	max.	

**Dynamic Characteristics**

Transconductance $V_{DS} \geq 2 \cdot I_D \cdot R_{DS(on)max}$ , $I_D = 1.7\text{ A}$	$g_{fs}$	1.5	2.8	-	S
Input capacitance $V_{GS} = 0\text{ V}$ , $V_{DS} = 25\text{ V}$ , $f = 1\text{ MHz}$	$C_{iss}$	-	400	550	pF
Output capacitance $V_{GS} = 0\text{ V}$ , $V_{DS} = 25\text{ V}$ , $f = 1\text{ MHz}$	$C_{oss}$	-	125	190	
Reverse transfer capacitance $V_{GS} = 0\text{ V}$ , $V_{DS} = 25\text{ V}$ , $f = 1\text{ MHz}$	$C_{rss}$	-	70	105	
Turn-on delay time $V_{DD} = 30\text{ V}$ , $V_{GS} = 10\text{ V}$ , $I_D = 0.3\text{ A}$ $R_{GS} = 50\ \Omega$	$t_{d(on)}$	-	10	15	ns
Rise time $V_{DD} = 30\text{ V}$ , $V_{GS} = 10\text{ V}$ , $I_D = 0.3\text{ A}$ $R_{GS} = 50\ \Omega$	$t_r$	-	30	45	
Turn-off delay time $V_{DD} = 30\text{ V}$ , $V_{GS} = 10\text{ V}$ , $I_D = 0.3\text{ A}$ $R_{GS} = 50\ \Omega$	$t_{d(off)}$	-	85	115	
Fall time $V_{DD} = 30\text{ V}$ , $V_{GS} = 10\text{ V}$ , $I_D = 0.3\text{ A}$ $R_{GS} = 50\ \Omega$	$t_f$	-	60	80	

**Electrical Characteristics, at  $T_j = 25^\circ\text{C}$ , unless otherwise specified**

Parameter	Symbol	Values			Unit
		min.	typ.	max.	
<b>Reverse Diode</b>					
Inverse diode continuous forward current $T_A = 25^\circ\text{C}$	$I_S$	-	-	1.7	A
Inverse diode direct current, pulsed $T_A = 25^\circ\text{C}$	$I_{SM}$	-	-	6.8	
Inverse diode forward voltage $V_{GS} = 0\text{ V}, I_F = 1.7\text{ A}, T_j = 25^\circ\text{C}$	$V_{SD}$	-	0.8	1.1	V
Reverse recovery time $V_R = 30\text{ V}, I_F = I_S, di_F/dt = 100\text{ A}/\mu\text{s}$	$t_{rr}$	-	-	-	ns
Reverse recovery charge $V_R = 30\text{ V}, I_F = I_S, di_F/dt = 100\text{ A}/\mu\text{s}$	$Q_{rr}$	-	-	-	$\mu\text{C}$

**Power dissipation**

$P_{tot} = f(T_A)$

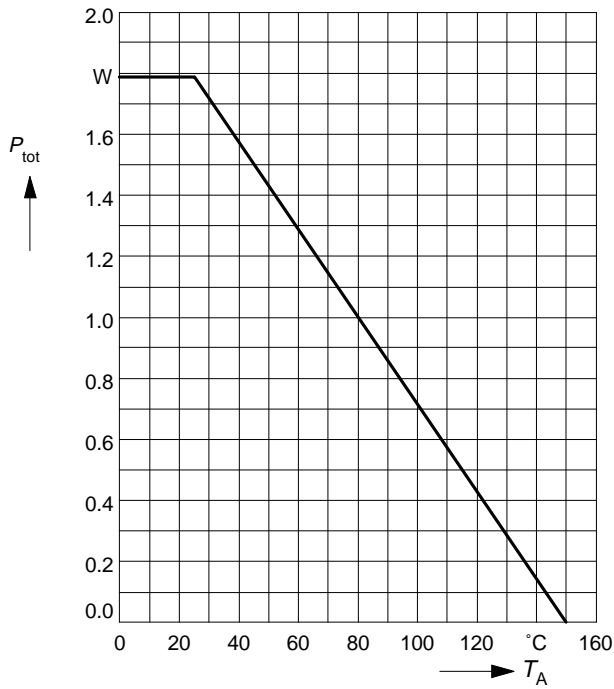

**Drain current**

$I_D = f(T_A)$   
parameter:  $V_{GS} \geq 10\text{ V}$

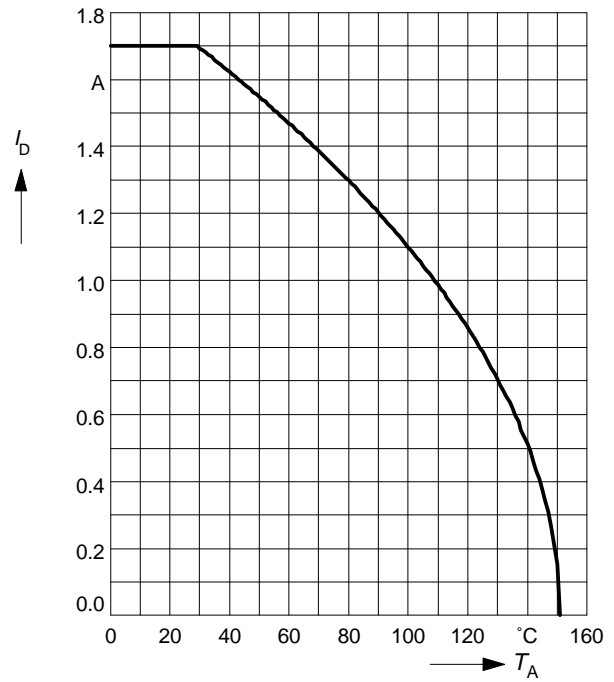

**Safe operating area  $I_D = f(V_{DS})$**

parameter :  $D = 0, T_C = 25^\circ\text{C}$

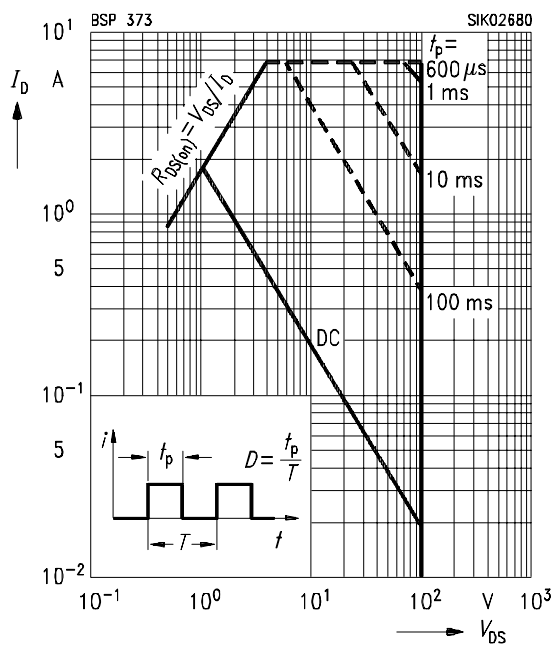

**Transient thermal impedance**

$Z_{thJA} = f(t_p)$   
parameter:  $D = t_p / T$

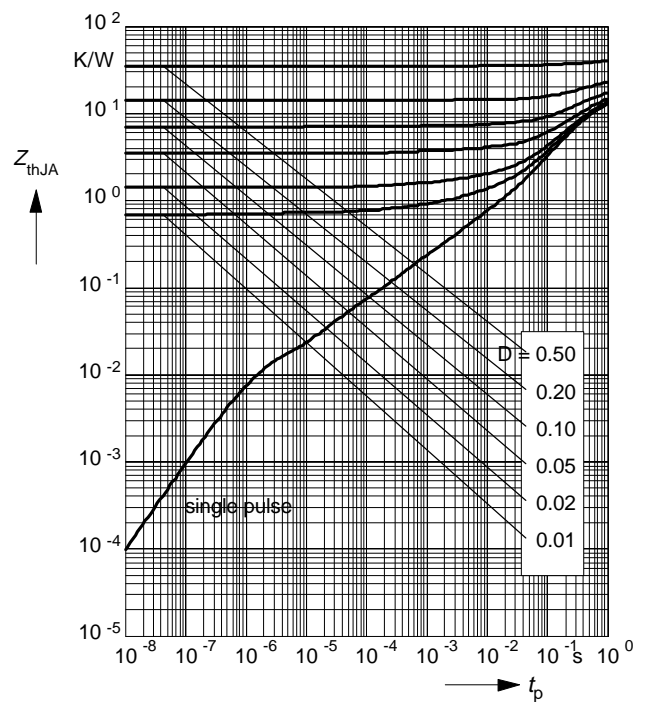

**Typ. output characteristics**

$I_D = f(V_{DS})$

parameter:  $t_p = 80 \mu s$

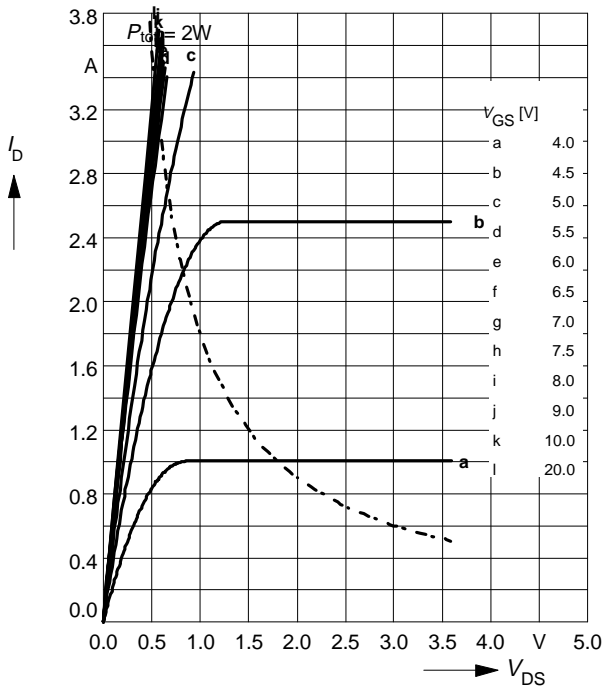

**Typ. drain-source on-resistance**

$R_{DS(on)} = f(I_D)$

parameter:  $t_p = 80 \mu s, T_j = 25^\circ C$

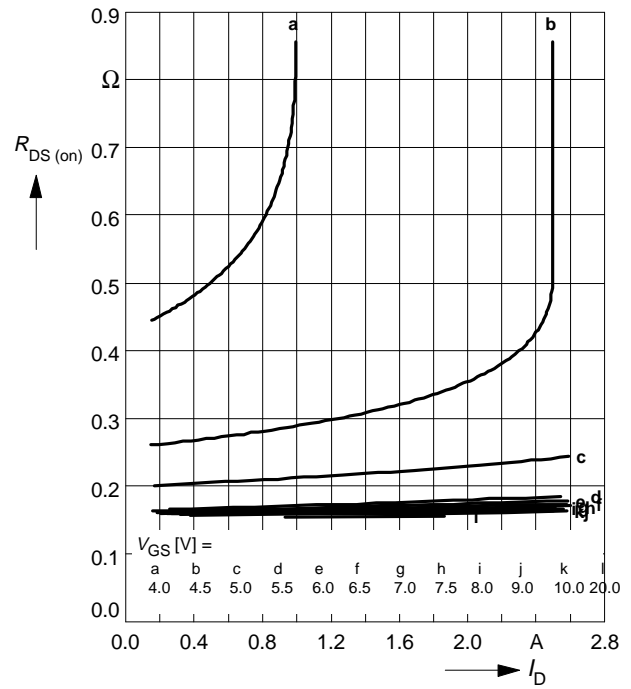

**Typ. transfer characteristics  $I_D = f(V_{GS})$**

parameter:  $t_p = 80 \mu s$

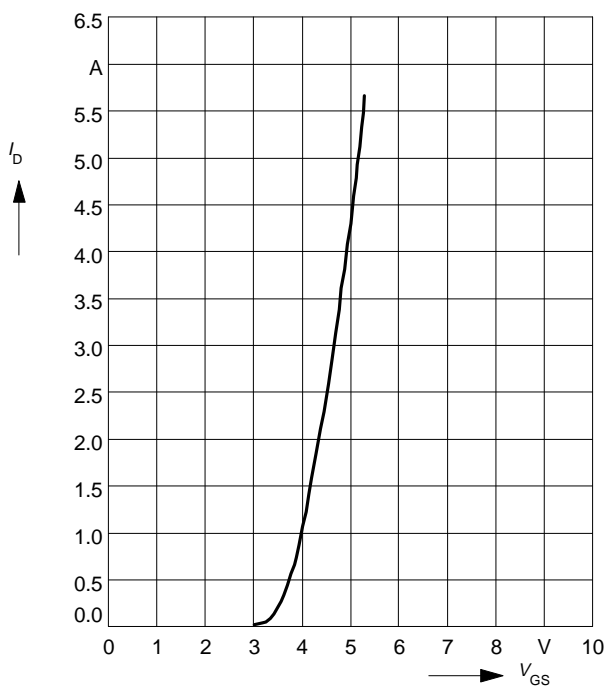

**Typ. forward transconductance  $g_{fs} = f(I_D)$**

parameter:  $t_p = 80 \mu s,$

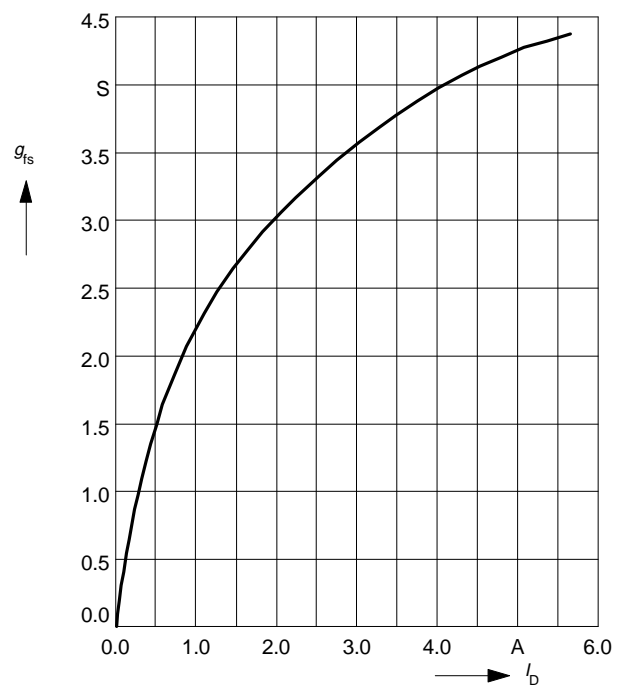

**Drain-source on-resistance**

$$R_{DS(on)} = f(T_j)$$

parameter:  $I_D = 1.7 \text{ A}$ ,  $V_{GS} = 10 \text{ V}$

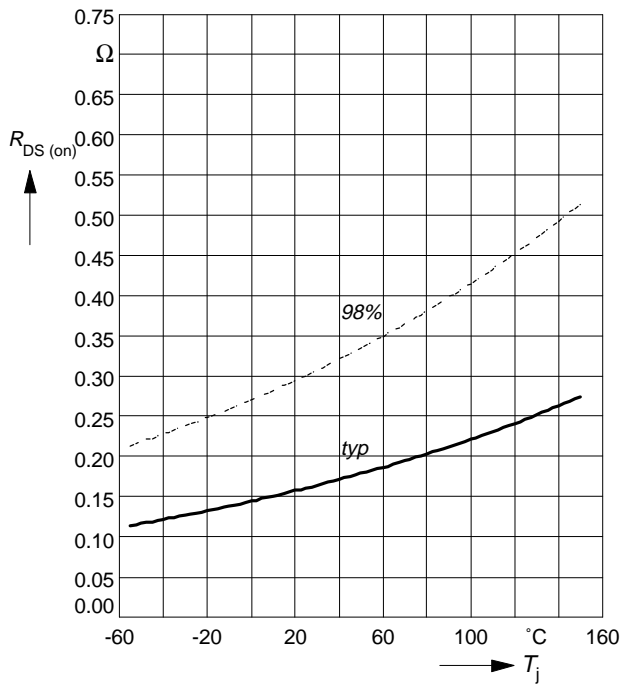

**Gate threshold voltage**

$$V_{GS(th)} = f(T_j)$$

parameter:  $V_{GS} = V_{DS}$ ,  $I_D = 1 \text{ mA}$

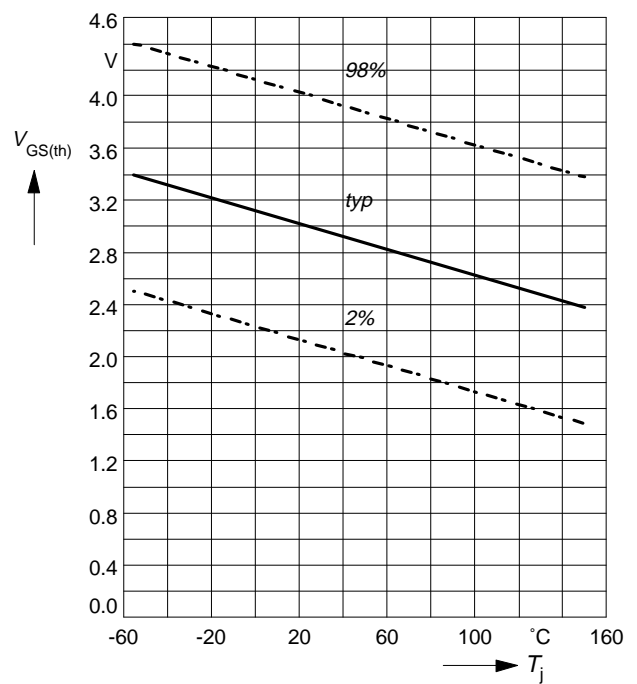

**Typ. capacitances**

$$C = f(V_{DS})$$

parameter:  $V_{GS} = 0 \text{ V}$ ,  $f = 1 \text{ MHz}$

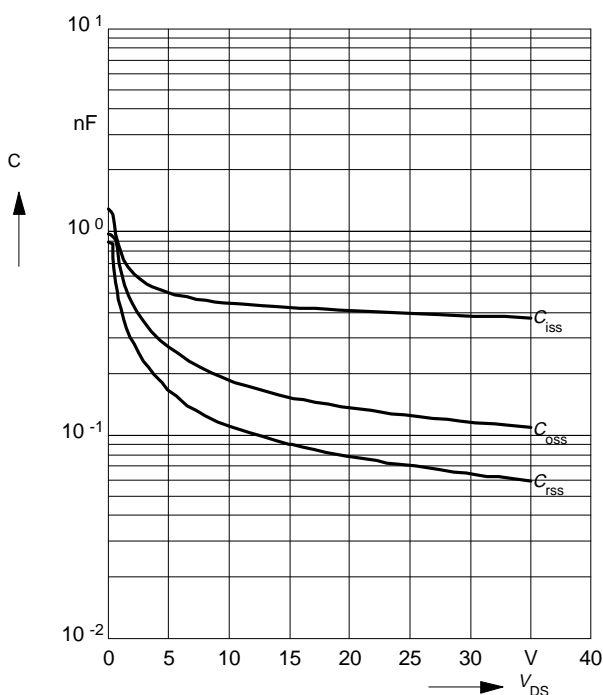

**Forward characteristics of reverse diode**

$$I_F = f(V_{SD})$$

parameter:  $T_j, t_p = 80 \mu\text{s}$

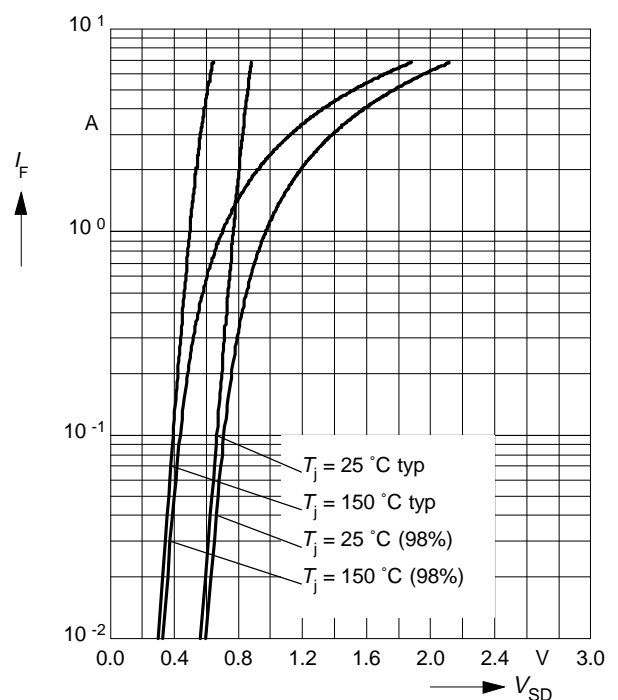

**Avalanche energy**  $E_{AS} = f(T_j)$   
 parameter:  $I_D = 1.7 \text{ A}$ ,  $V_{DD} = 25 \text{ V}$   
 $R_{GS} = 25 \Omega$ ,  $L = 23.3 \text{ mH}$

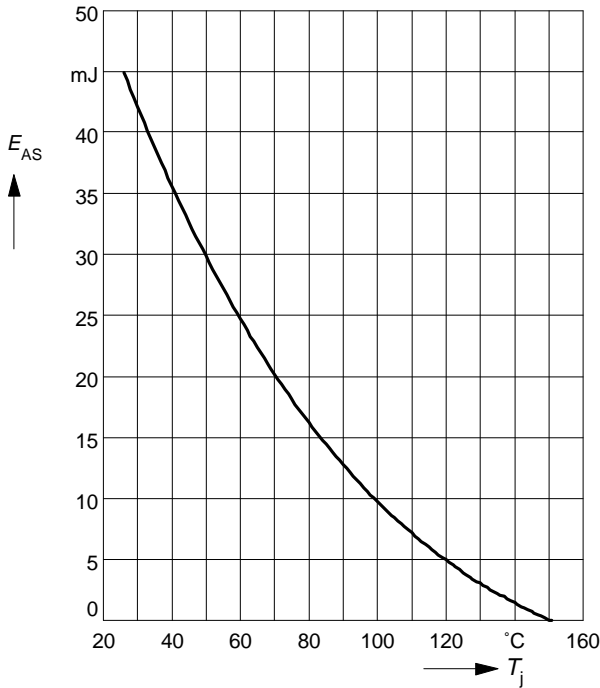

**Drain-source breakdown voltage**

$V_{(BR)DSS} = f(T_j)$

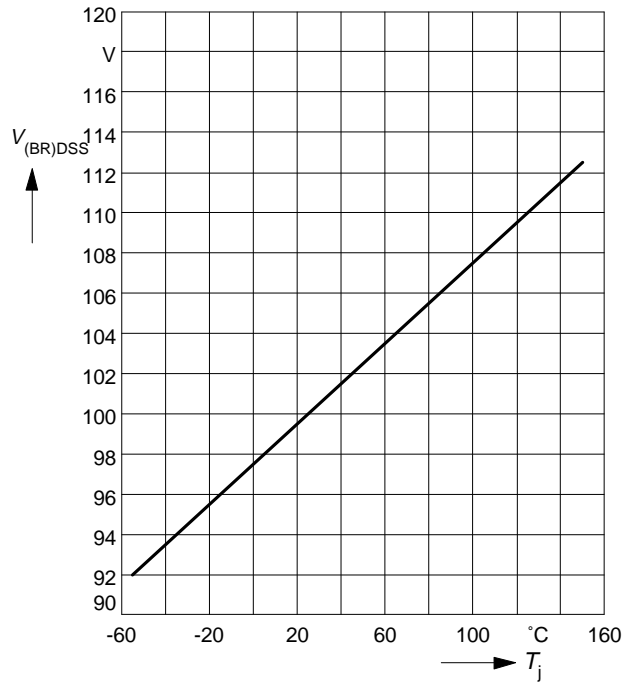

**Safe operating area**  $I_D = f(V_{DS})$

parameter :  $D = 0.01$ ,  $T_C = 25^\circ\text{C}$

