



BF1210

Dual N-channel dual gate MOSFET

Rev. 01 — 25 October 2006

Product data sheet

1. Product profile

1.1 General description

The BF1210 is a combination of two dual gate MOSFET amplifiers with shared source and gate2 leads.

The source and substrate are interconnected. Internal bias circuits enable DC stabilization and a very good cross modulation performance during AGC. Integrated diodes between the gates and source protect against excessive input voltage surges. The transistor has a SOT363 micro-miniature plastic package.

CAUTION



This device is sensitive to ElectroStatic Discharge (ESD). Therefore care should be taken during transport and handling.

1.2 Features

- Two low noise gain controlled amplifiers in a single package; both with a partly integrated bias
- Superior cross modulation performance during AGC
- High forward transfer admittance
- High forward transfer admittance to input capacitance ratio

1.3 Applications

- Gain controlled low noise amplifiers for VHF and UHF applications with 5 V supply voltage
 - ◆ digital and analog television tuners
 - ◆ professional communication equipment

1.4 Quick reference data

Table 1. Quick reference data
Per MOSFET unless otherwise specified.

Symbol	Parameter	Conditions	Min	Typ	Max	Unit
V_{DS}	drain-source voltage		-	-	6	V
I_D	drain current	DC	-	-	30	mA
P_{tot}	total power dissipation	$T_{sp} \leq 107\text{ }^\circ\text{C}$	[1]	-	180	mW
$ y_{fs} $	forward transfer admittance	amplifier A; $I_D = 19\text{ mA}$	26	31	41	mS
		amplifier B; $I_D = 13\text{ mA}$	28	33	43	mS
$C_{iss(G1)}$	input capacitance at gate1	$f = 100\text{ MHz}$	[2]			
		amplifier A	-	2.2	2.7	pF
		amplifier B	-	1.9	2.4	pF
C_{rss}	reverse transfer capacitance	$f = 100\text{ MHz}$	[2]	20	-	fF
NF	noise figure	amplifier A; $f = 400\text{ MHz}$	-	0.9	1.5	dB
		amplifier B; $f = 800\text{ MHz}$	-	1.2	1.9	dB
Xmod	cross modulation	input level for $k = 1\%$ at 40 dB AGC				
		amplifier A	100	105	-	dB μ V
		amplifier B	100	103	-	dB μ V
T_j	junction temperature		-	-	150	$^\circ\text{C}$

[1] T_{sp} is the temperature at the soldering point of the source lead.

[2] Calculated from S-parameters.

2. Pinning information

Table 2. Discrete pinning

Pin	Description	Simplified outline	Symbol
1	gate1 (AMP A)		
2	gate2		
3	gate1 (AMP B)		
4	drain (AMP B)		
5	source		
6	drain (AMP A)		

sym119

3. Ordering information

Table 3. Ordering information

Type number	Package		Version
	Name	Description	
BF1210	-	plastic surface-mounted package; 6 leads	SOT363

4. Marking

Table 4. Marking

Type number	Marking	Description
BF1210	*AB	* = p : made in Hong Kong * = t : made in Malaysia * = w : made in China

5. Limiting values

Table 5. Limiting values

In accordance with the Absolute Maximum Rating System (IEC 60134).

Symbol	Parameter	Conditions	Min	Max	Unit
Per MOSFET					
V_{DS}	drain-source voltage		-	6	V
I_D	drain current	DC	-	30	mA
I_{G1}	gate1 current		-	±10	mA
I_{G2}	gate2 current		-	±10	mA
P_{tot}	total power dissipation	$T_{sp} \leq 107\text{ °C}$ [1]	-	180	mW
T_{stg}	storage temperature		-65	+150	°C
T_j	junction temperature		-	150	°C

[1] T_{sp} is the temperature at the soldering point of the source lead.

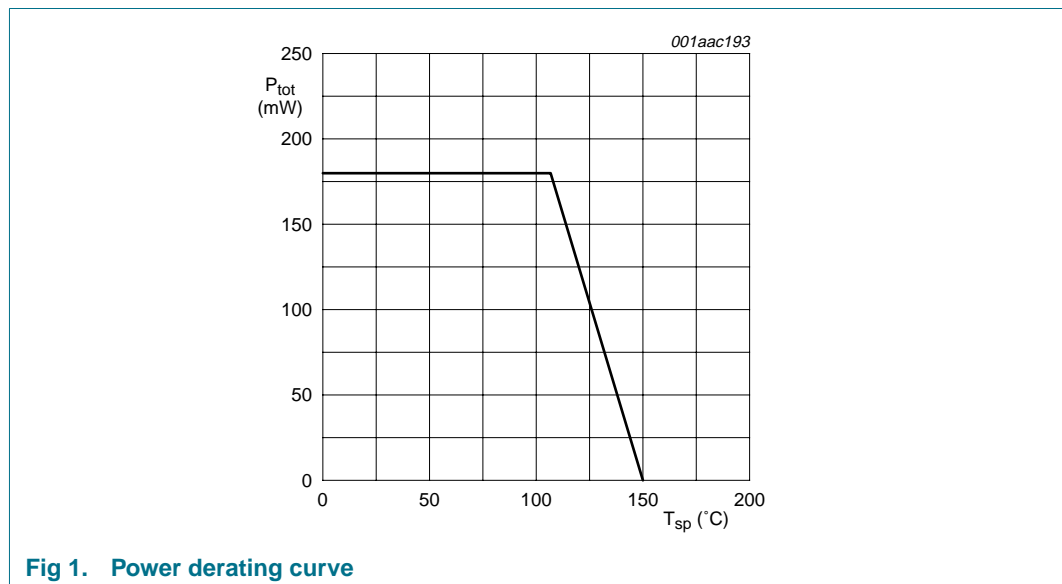

Fig 1. Power derating curve

6. Thermal characteristics

Table 6. Thermal characteristics

Symbol	Parameter	Conditions	Typ	Unit
$R_{th(j-sp)}$	thermal resistance from junction to solder point		240	K/W

7. Static characteristics

Table 7. Static characteristics

$T_j = 25\text{ }^\circ\text{C}$.

Symbol	Parameter	Conditions	Min	Typ	Max	Unit
Per MOSFET; unless otherwise specified						
$V_{(BR)DSS}$	drain-source breakdown voltage	$V_{G1-S} = V_{G2-S} = 0\text{ V}$; $I_D = 10\text{ }\mu\text{A}$				
		amplifier A	6	-	-	V
		amplifier B	6	-	-	V
$V_{(BR)G1-SS}$	gate1-source breakdown voltage	$V_{G2-S} = V_{DS} = 0\text{ V}$; $I_{G1-S} = 10\text{ mA}$	6	-	10	V
$V_{(BR)G2-SS}$	gate2-source breakdown voltage	$V_{G1-S} = V_{DS} = 0\text{ V}$; $I_{G2-S} = 10\text{ mA}$	6	-	10	V
$V_{F(S-G1)}$	forward source-gate1 voltage	$V_{G2-S} = V_{DS} = 0\text{ V}$; $I_{S-G1} = 10\text{ mA}$	0.5	-	1.5	V
$V_{F(S-G2)}$	forward source-gate2 voltage	$V_{G1-S} = V_{DS} = 0\text{ V}$; $I_{S-G2} = 10\text{ mA}$	0.5	-	1.5	V
$V_{G1-S(th)}$	gate1-source threshold voltage	$V_{DS} = 5\text{ V}$; $V_{G2-S} = 4\text{ V}$; $I_D = 100\text{ }\mu\text{A}$	0.3	-	1.0	V
$V_{G2-S(th)}$	gate2-source threshold voltage	$V_{DS} = 5\text{ V}$; $V_{G1-S} = 5\text{ V}$; $I_D = 100\text{ }\mu\text{A}$	0.4	-	1.0	V
I_{DS}	drain-source current	$V_{G2-S} = 4\text{ V}$	[1]			
		amplifier A; $V_{DS(A)} = 5\text{ V}$; $R_{G1(A)} = 59\text{ k}\Omega$	14	-	24	mA
		amplifier B; $V_{DS(B)} = 5\text{ V}$; $R_{G1(B)} = 150\text{ k}\Omega$	9	-	17	mA
I_{G1-S}	gate1 cut-off current	$V_{G2-S} = 0\text{ V}$; $V_{DS(A)} = V_{DS(B)} = 0\text{ V}$				
		amplifier A; $V_{G1-S(A)} = 5\text{ V}$	-	-	50	nA
		amplifier B; $V_{G1-S(B)} = 5\text{ V}$	-	-	50	nA
I_{G2-S}	gate2 cut-off current	$V_{G2-S} = 4\text{ V}$; $V_{DS(A)} = V_{DS(B)} = 0\text{ V}$; $V_{G1-S(A)} = V_{G1-S(B)} = 0\text{ V}$	-	-	20	nA

[1] R_{G1} connects gate1 to $V_{GG} = 5\text{ V}$. See [Figure 32](#).

8. Dynamic characteristics

8.1 Dynamic characteristics for amplifier A

Table 8. Dynamic characteristics for amplifier A

Common source; $T_{amb} = 25\text{ }^\circ\text{C}$; $V_{G2-S} = 4\text{ V}$; $V_{DS(A)} = 5\text{ V}$; $I_{D(A)} = 19\text{ mA}$.

Symbol	Parameter	Conditions	Min	Typ	Max	Unit
$ y_{fs} $	forward transfer admittance	$T_j = 25\text{ }^\circ\text{C}$	26	31	41	mS
$C_{iss(G1)}$	input capacitance at gate1	$f = 100\text{ MHz}$	[1]	-	2.2	2.7 pF
$C_{iss(G2)}$	input capacitance at gate2	$f = 100\text{ MHz}$	[1]	-	3.0	pF
C_{oss}	output capacitance	$f = 100\text{ MHz}$	[1]	-	0.9	pF
C_{rss}	reverse transfer capacitance	$f = 100\text{ MHz}$	[1]	-	20	fF

Table 8. Dynamic characteristics for amplifier A ...continued
 Common source; $T_{amb} = 25\text{ }^{\circ}\text{C}$; $V_{G2-S} = 4\text{ V}$; $V_{DS(A)} = 5\text{ V}$; $I_{D(A)} = 19\text{ mA}$.

Symbol	Parameter	Conditions	Min	Typ	Max	Unit
G _{tr}	transducer power gain	B _S = B _{S(opt)} ; B _L = B _{L(opt)}	[1]			
		f = 200 MHz; G _S = 2 mS; G _L = 0.5 mS	31	35	39	dB
		f = 400 MHz; G _S = 2 mS; G _L = 1 mS	27	31	35	dB
		f = 800 MHz; G _S = 3.3 mS; G _L = 1 mS	22	26	30	dB
NF	noise figure	f = 11 MHz; G _S = 20 mS; B _S = 0 S	-	3	-	dB
		f = 400 MHz; Y _S = Y _{S(opt)}	-	0.9	1.5	dB
		f = 800 MHz; Y _S = Y _{S(opt)}	-	1.2	1.9	dB
X _{mod}	cross modulation	input level for k = 1 %; f _w = 50 MHz; f _{unw} = 60 MHz	[2]			
		at 0 dB AGC	90	-	-	dBμV
		at 10 dB AGC	-	90	-	dBμV
		at 20 dB AGC	-	99	-	dBμV
		at 40 dB AGC	100	105	-	dBμV

[1] Calculated from S-parameters.

[2] Measured in [Figure 32](#) test circuit.

8.1.1 Graphs for amplifier A

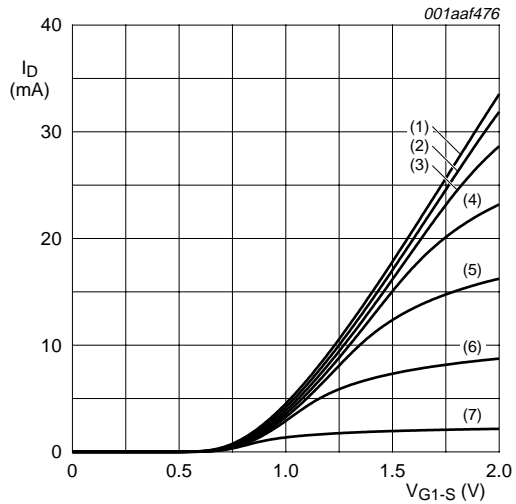

- (1) $V_{G2-S} = 4.0 \text{ V}$.
 - (2) $V_{G2-S} = 3.5 \text{ V}$.
 - (3) $V_{G2-S} = 3.0 \text{ V}$.
 - (4) $V_{G2-S} = 2.5 \text{ V}$.
 - (5) $V_{G2-S} = 2.0 \text{ V}$.
 - (6) $V_{G2-S} = 1.5 \text{ V}$.
 - (7) $V_{G2-S} = 1.0 \text{ V}$.
- $V_{DS(A)} = 5 \text{ V}; T_j = 25 \text{ }^\circ\text{C}$.

Fig 2. Amplifier A: transfer characteristics; typical values

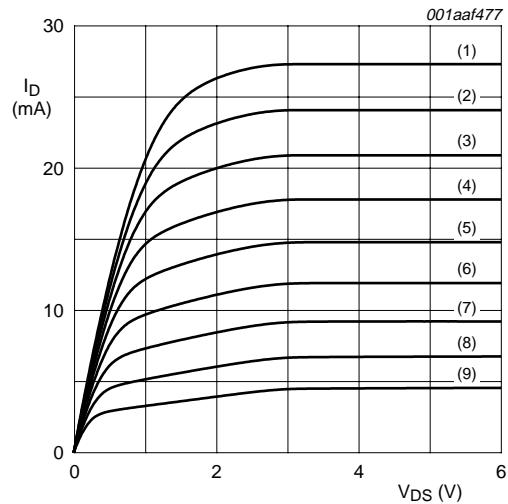

- (1) $V_{G1-S(A)} = 1.8 \text{ V}$.
 - (2) $V_{G1-S(A)} = 1.7 \text{ V}$.
 - (3) $V_{G1-S(A)} = 1.6 \text{ V}$.
 - (4) $V_{G1-S(A)} = 1.5 \text{ V}$.
 - (5) $V_{G1-S(A)} = 1.4 \text{ V}$.
 - (6) $V_{G1-S(A)} = 1.3 \text{ V}$.
 - (7) $V_{G1-S(A)} = 1.2 \text{ V}$.
 - (8) $V_{G1-S(A)} = 1.1 \text{ V}$.
 - (9) $V_{G1-S(A)} = 1.0 \text{ V}$.
- $V_{G2-S} = 4 \text{ V}; T_j = 25 \text{ }^\circ\text{C}$.

Fig 3. Amplifier A: output characteristics; typical values

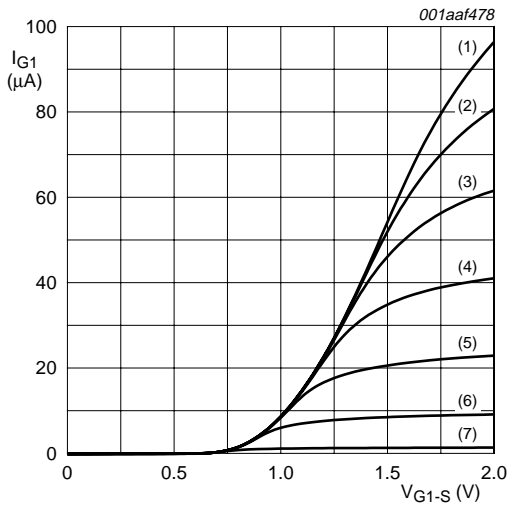

(1) $V_{G2-S} = 4.0\text{ V}$.
 (2) $V_{G2-S} = 3.5\text{ V}$.
 (3) $V_{G2-S} = 3.0\text{ V}$.
 (4) $V_{G2-S} = 2.5\text{ V}$.
 (5) $V_{G2-S} = 2.0\text{ V}$.
 (6) $V_{G2-S} = 1.5\text{ V}$.
 (7) $V_{G2-S} = 1.0\text{ V}$.
 $V_{DS(A)} = 5\text{ V}$; $T_j = 25\text{ }^\circ\text{C}$.

Fig 4. Amplifier A: gate1 current as a function of gate1 voltage; typical values

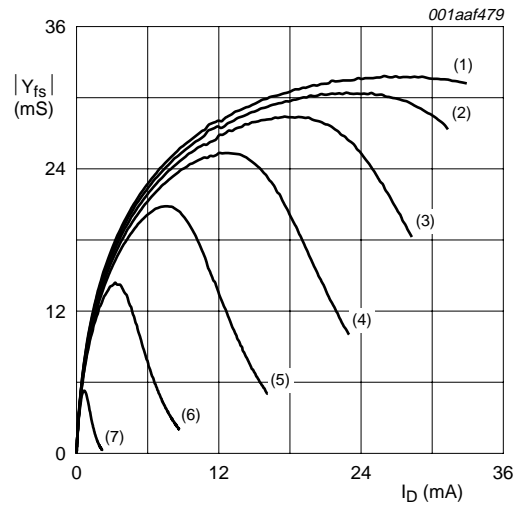

(1) $V_{G2-S} = 4.0\text{ V}$.
 (2) $V_{G2-S} = 3.5\text{ V}$.
 (3) $V_{G2-S} = 3.0\text{ V}$.
 (4) $V_{G2-S} = 2.5\text{ V}$.
 (5) $V_{G2-S} = 2.0\text{ V}$.
 (6) $V_{G2-S} = 1.5\text{ V}$.
 (7) $V_{G2-S} = 1.0\text{ V}$.
 $V_{DS(A)} = 5\text{ V}$; $T_j = 25\text{ }^\circ\text{C}$.

Fig 5. Amplifier A: forward transfer admittance as a function of drain current; typical values

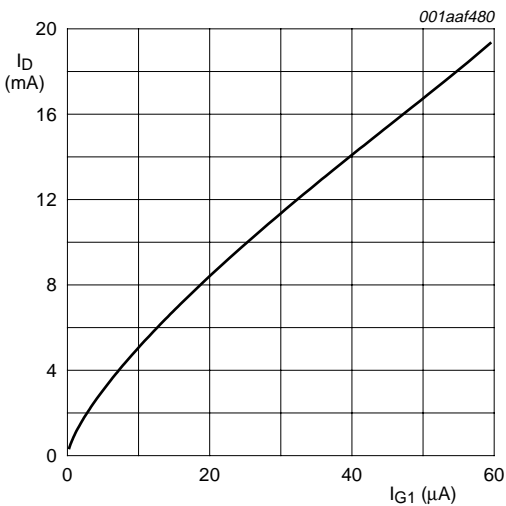

$V_{DS(A)} = 5\text{ V}$; $V_{G2-S} = 4\text{ V}$; $T_j = 25\text{ }^\circ\text{C}$.

Fig 6. Amplifier A: drain current as a function of gate1 current; typical values

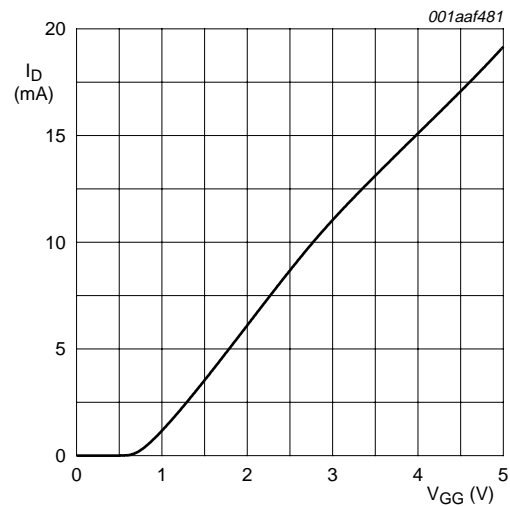

$V_{DS(A)} = 5\text{ V}$; $V_{G2-S} = 4\text{ V}$; $R_{G1(A)} = 59\text{ k}\Omega$; $T_j = 25\text{ }^\circ\text{C}$.

Fig 7. Amplifier A: drain current as a function of gate1 supply voltage (V_{GG}); typical values

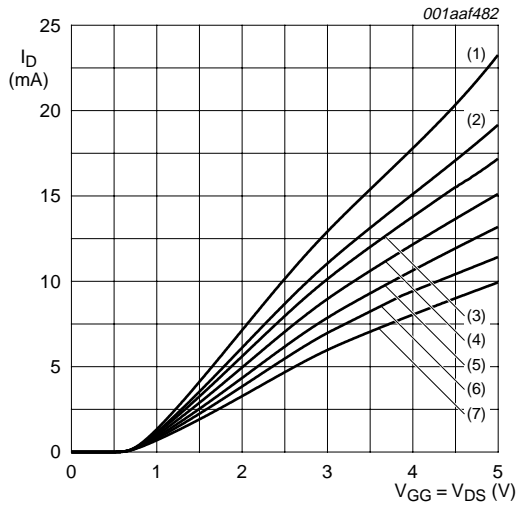

- (1) $R_{G1(A)} = 47 \text{ k}\Omega$.
 - (2) $R_{G1(A)} = 59 \text{ k}\Omega$.
 - (3) $R_{G1(A)} = 68 \text{ k}\Omega$.
 - (4) $R_{G1(A)} = 82 \text{ k}\Omega$.
 - (5) $R_{G1(A)} = 100 \text{ k}\Omega$.
 - (6) $R_{G1(A)} = 120 \text{ k}\Omega$.
 - (7) $R_{G1(A)} = 150 \text{ k}\Omega$.
- $V_{G2-S} = 4 \text{ V}$; $T_j = 25 \text{ }^\circ\text{C}$.

Fig 8. Amplifier A: drain current as a function of V_{DS} and V_{GG} ; typical values

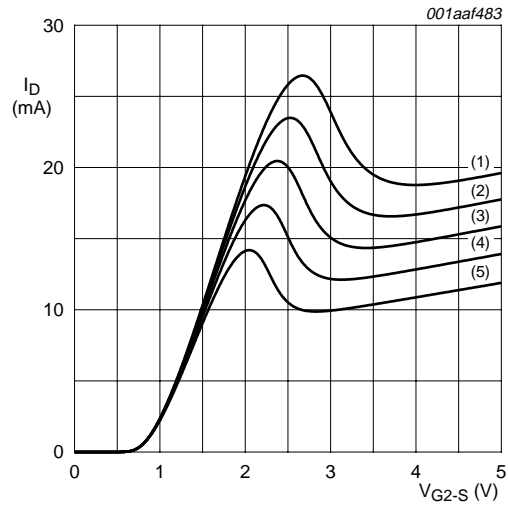

- (1) $V_{GG} = 5.0 \text{ V}$.
 - (2) $V_{GG} = 4.5 \text{ V}$.
 - (3) $V_{GG} = 4.0 \text{ V}$.
 - (4) $V_{GG} = 3.5 \text{ V}$.
 - (5) $V_{GG} = 3.0 \text{ V}$.
- $T_j = 25 \text{ }^\circ\text{C}$; $R_{G1(A)} = 59 \text{ k}\Omega$ (connected to V_{GG}).

Fig 9. Amplifier A: drain current as a function of gate2 voltage; typical values

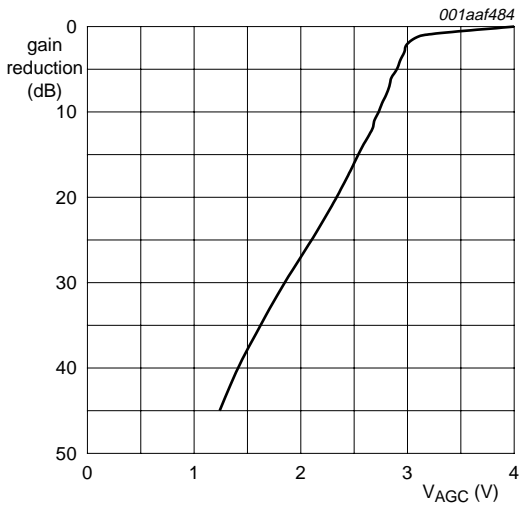

$V_{DS(A)} = 5\text{ V}$; $V_{GG} = 5\text{ V}$; $I_{D(nom)(A)} = 19\text{ mA}$;
 $R_{G1(A)} = 59\text{ k}\Omega$; $f = 50\text{ MHz}$; $T_{amb} = 25\text{ }^\circ\text{C}$;
 see [Figure 32](#).

Fig 10. Amplifier A: typical gain reduction as a function of the AGC voltage; typical values

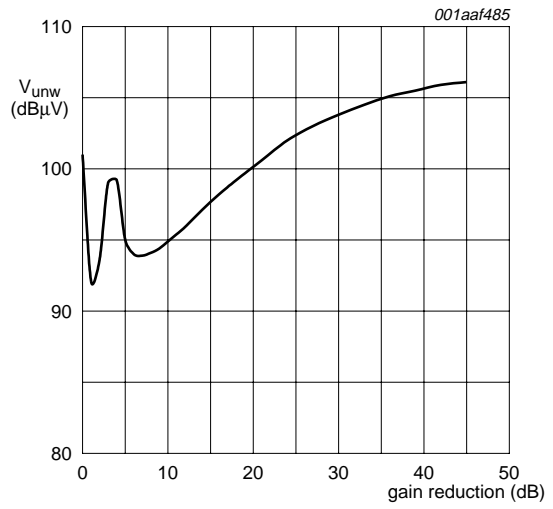

$V_{DS(A)} = 5\text{ V}$; $V_{GG} = 5\text{ V}$; $V_{G2-S(nom)} = 4\text{ V}$;
 $R_{G1(A)} = 59\text{ k}\Omega$; $f_w = 50\text{ MHz}$; $f_{unw} = 60\text{ MHz}$;
 $I_{D(nom)(A)} = 19\text{ mA}$; $T_{amb} = 25\text{ }^\circ\text{C}$; see [Figure 32](#).

Fig 11. Amplifier A: unwanted voltage for 1% cross modulation as a function of gain reduction; typical values

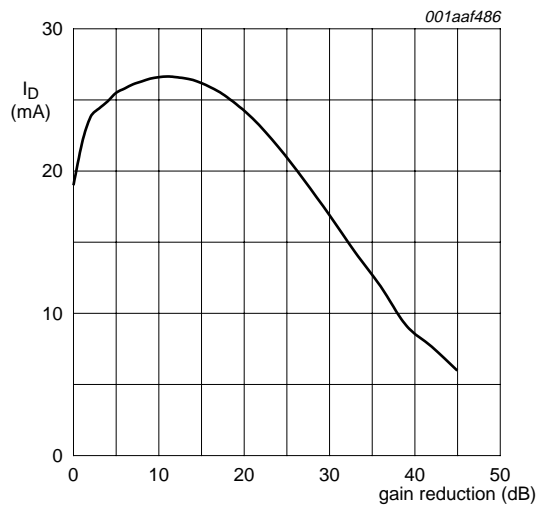

$V_{DS(A)} = 5\text{ V}$; $V_{GG} = 5\text{ V}$; $V_{G2-S(nom)} = 4\text{ V}$; $R_{G1(A)} = 59\text{ k}\Omega$; $f = 50\text{ MHz}$; $I_{D(nom)(A)} = 19\text{ mA}$; $T_{amb} = 25\text{ }^\circ\text{C}$; see [Figure 32](#).

Fig 12. Amplifier A: typical drain current as a function of gain reduction; typical values

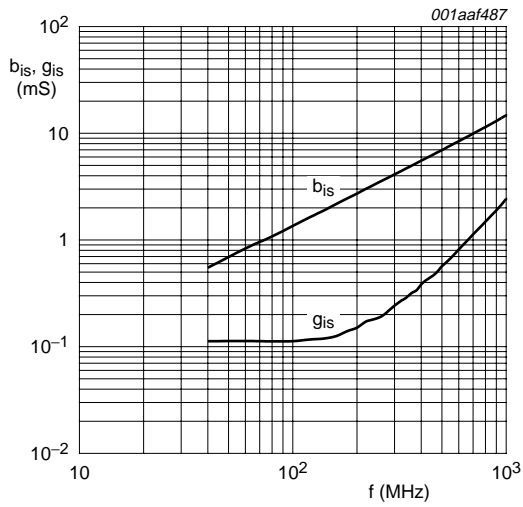

$V_{DS(A)} = 5\text{ V}; V_{G2-S} = 4\text{ V}; V_{DS(B)} = 0\text{ V};$
 $I_{D(A)} = 19\text{ mA}.$

Fig 13. Amplifier A: input admittance as a function of frequency; typical values

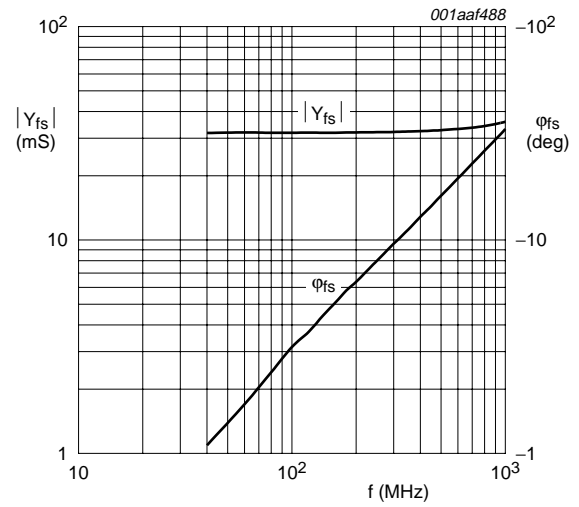

$V_{DS(A)} = 5\text{ V}; V_{G2-S} = 4\text{ V}; V_{DS(B)} = 0\text{ V};$
 $I_{D(A)} = 19\text{ mA}.$

Fig 14. Amplifier A: forward transfer admittance and phase as a function of frequency; typical values

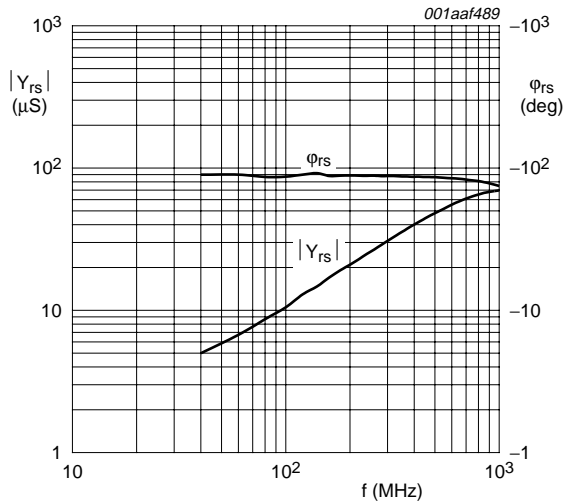

$V_{DS(A)} = 5\text{ V}; V_{G2-S} = 4\text{ V}; V_{DS(B)} = 0\text{ V};$
 $I_{D(A)} = 19\text{ mA}.$

Fig 15. Amplifier A: reverse transfer admittance and phase as a function of frequency; typical values

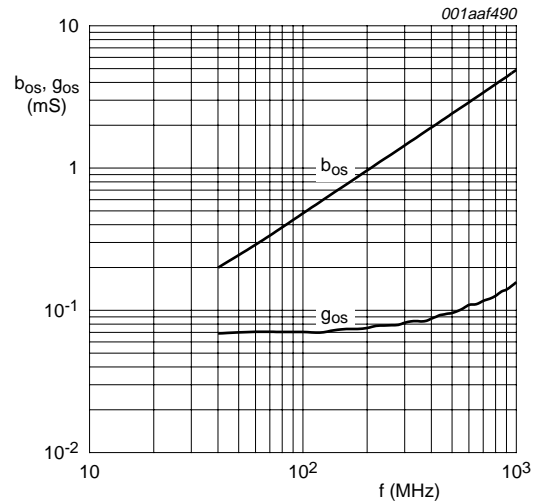

$V_{DS(A)} = 5\text{ V}; V_{G2-S} = 4\text{ V}; V_{DS(B)} = 0\text{ V};$
 $I_{D(A)} = 19\text{ mA}.$

Fig 16. Amplifier A: output admittance as a function of frequency; typical values

8.1.2 Scattering parameters for amplifier A

Table 9. Scattering parameters for amplifier A

$V_{DS(A)} = 5\text{ V}$; $V_{G2-S} = 4\text{ V}$; $I_{D(A)} = 19\text{ mA}$; $V_{DS(B)} = 0\text{ V}$; $V_{G1-S(B)} = 0\text{ V}$; $T_{amb} = 25\text{ °C}$; typical values.

f (MHz)	S ₁₁		S ₂₁		S ₁₂		S ₂₂	
	Magnitude (ratio)	Angle (deg)	Magnitude (ratio)	Angle (deg)	Magnitude (ratio)	Angle (deg)	Magnitude (ratio)	Angle (deg)
40	0.9861	-3.2	3.14	176.75	0.00054	87.97	0.9934	-1.19
100	0.9883	-7.84	3.14	171.53	0.00104	87.69	0.9925	-2.85
200	0.9844	-15.7	3.12	163.1	0.00205	80.77	0.9918	-5.69
300	0.9761	-23.52	3.08	154.65	0.00295	76.33	0.9904	-8.51
400	0.9635	-31.26	3.03	146.33	0.00375	72.34	0.9888	-11.33
500	0.9486	-38.78	2.97	138.15	0.00437	67.97	0.9870	-14.13
600	0.9305	-46.2	2.90	130.12	0.00483	64.86	0.9847	-16.87
700	0.9105	-53.33	2.81	122.26	0.0051	62.13	0.9832	-19.61
800	0.8911	-60.2	2.73	114.65	0.0052	59.88	0.9817	-22.35
900	0.8723	-67.03	2.65	107.2	0.00515	58.8	0.9796	-25.03
1000	0.8521	-73.74	2.56	99.78	0.00498	58.03	0.9785	-27.08

8.2 Noise data for amplifier A

Table 10. Noise data for amplifier A

$V_{DS(A)} = 5\text{ V}$; $V_{G2-S} = 4\text{ V}$; $I_{D(A)} = 19\text{ mA}$; $T_{amb} = 25\text{ °C}$; typical values.

f (MHz)	NF _{min} (dB)	Γ _{opt}		r _n (ratio)
		(ratio)	(deg)	
400	0.9	0.749	23.7	0.667
800	1.2	0.688	48.65	0.583

8.3 Dynamic characteristics for amplifier B

Table 11. Dynamic characteristics for amplifier B

Common source; $T_{amb} = 25\text{ °C}$; $V_{G2-S} = 4\text{ V}$; $V_{DS(B)} = 5\text{ V}$; $I_{D(B)} = 13\text{ mA}$.

Symbol	Parameter	Conditions	Min	Typ	Max	Unit
y _{fsl}	forward transfer admittance	T _j = 25 °C	28	33	43	mS
C _{iss(G1)}	input capacitance at gate1	f = 100 MHz	[1]	-	1.9	2.4 pF
C _{iss(G2)}	input capacitance at gate2	f = 100 MHz	[1]	-	3.4	- pF
C _{oss}	output capacitance	f = 100 MHz	[1]	-	0.85	- pF
C _{rss}	reverse transfer capacitance	f = 100 MHz	[1]	-	20	- fF
G _{tr}	transducer power gain	B _S = B _{S(opt)} ; B _L = B _{L(opt)}	[1]			
		f = 200 MHz; G _S = 2 mS; G _L = 0.5 mS	32	36	40	dB
		f = 400 MHz; G _S = 2 mS; G _L = 1 mS	29	33	37	dB
		f = 800 MHz; G _S = 3.3 mS; G _L = 1 mS	27	31	35	dB
NF	noise figure	f = 11 MHz; G _S = 20 mS; B _S = 0 S	-	4	-	dB
		f = 400 MHz; Y _S = Y _{S(opt)}	-	0.9	1.5	dB
		f = 800 MHz; Y _S = Y _{S(opt)}	-	1.2	1.9	dB

Table 11. Dynamic characteristics for amplifier B ...continued
 Common source; $T_{amb} = 25\text{ }^{\circ}\text{C}$; $V_{G2-S} = 4\text{ V}$; $V_{DS(B)} = 5\text{ V}$; $I_{D(B)} = 13\text{ mA}$.

Symbol	Parameter	Conditions	Min	Typ	Max	Unit
Xmod	cross modulation	input level for $k = 1\%$; $f_w = 50\text{ MHz}$; $f_{unw} = 60\text{ MHz}$	[2]			
		at 0 dB AGC	90	-	-	dB μ V
		at 10 dB AGC	-	88	-	dB μ V
		at 20 dB AGC	-	94	-	dB μ V
		at 40 dB AGC	100	103	-	dB μ V

- [1] Calculated from S-parameters.
- [2] Measured in [Figure 32](#) test circuit.

8.3.1 Graphs for amplifier B

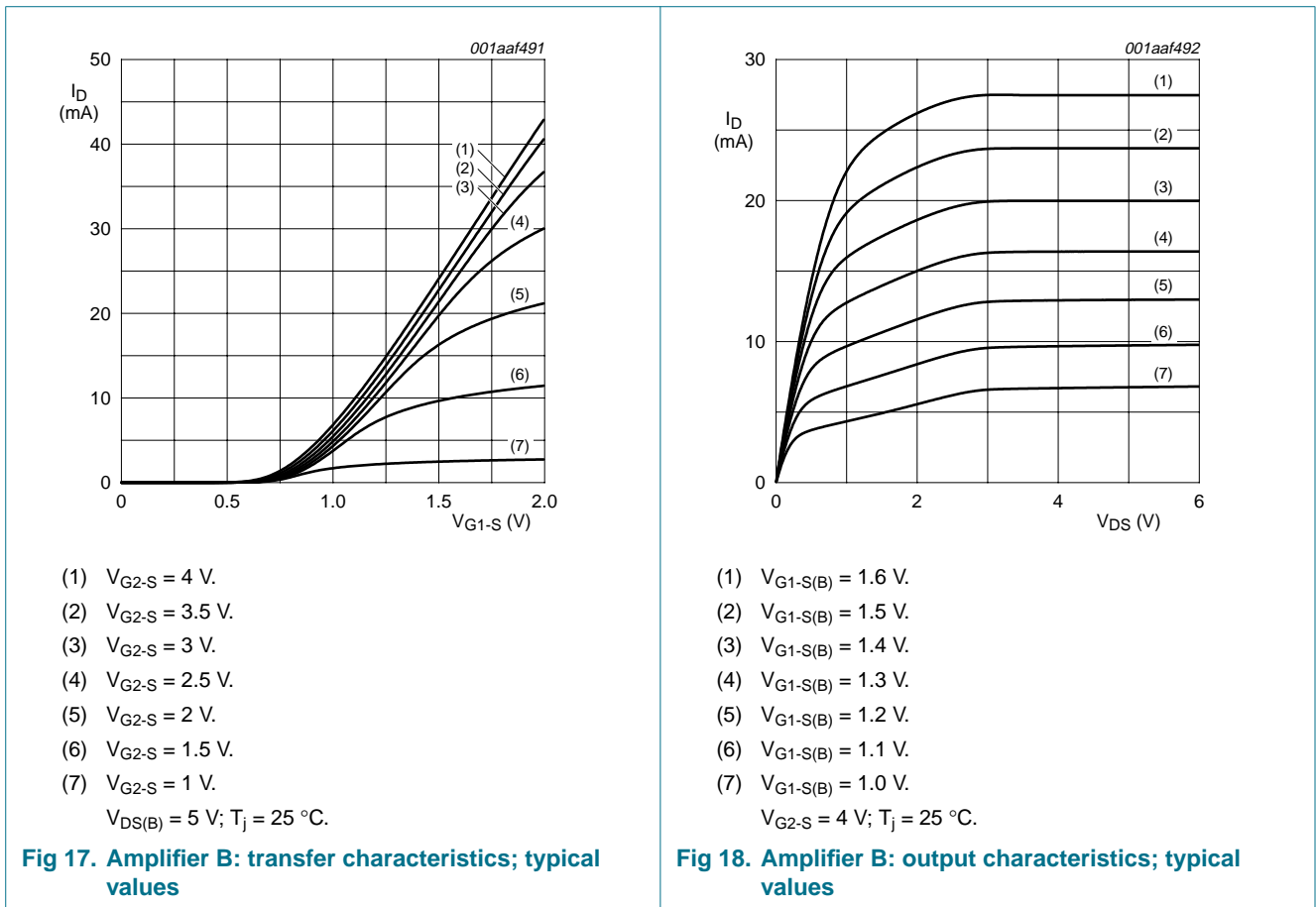

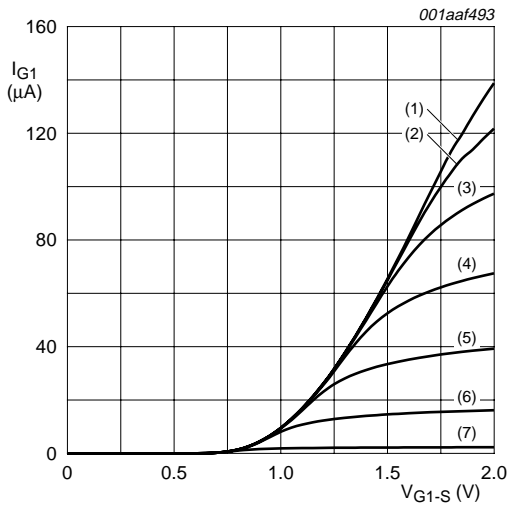

- (1) $V_{G2-S} = 4 \text{ V}$.
 - (2) $V_{G2-S} = 3.5 \text{ V}$.
 - (3) $V_{G2-S} = 3 \text{ V}$.
 - (4) $V_{G2-S} = 2.5 \text{ V}$.
 - (5) $V_{G2-S} = 2 \text{ V}$.
 - (6) $V_{G2-S} = 1.5 \text{ V}$.
 - (7) $V_{G2-S} = 1 \text{ V}$.
- $V_{DS(B)} = 5 \text{ V}; T_j = 25 \text{ }^\circ\text{C}$.

Fig 19. Amplifier B: gate1 current as a function of gate1 voltage; typical values

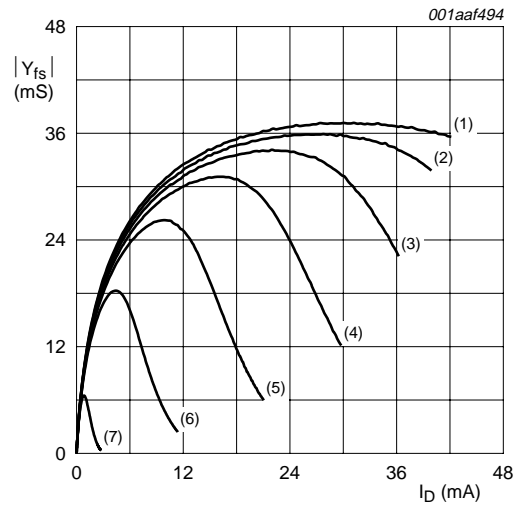

- (1) $V_{G2-S} = 4 \text{ V}$.
 - (2) $V_{G2-S} = 3.5 \text{ V}$.
 - (3) $V_{G2-S} = 3 \text{ V}$.
 - (4) $V_{G2-S} = 2.5 \text{ V}$.
 - (5) $V_{G2-S} = 2 \text{ V}$.
 - (6) $V_{G2-S} = 1.5 \text{ V}$.
 - (7) $V_{G2-S} = 1 \text{ V}$.
- $V_{DS(B)} = 5 \text{ V}; T_j = 25 \text{ }^\circ\text{C}$.

Fig 20. Amplifier B: forward transfer admittance as a function of drain current; typical values

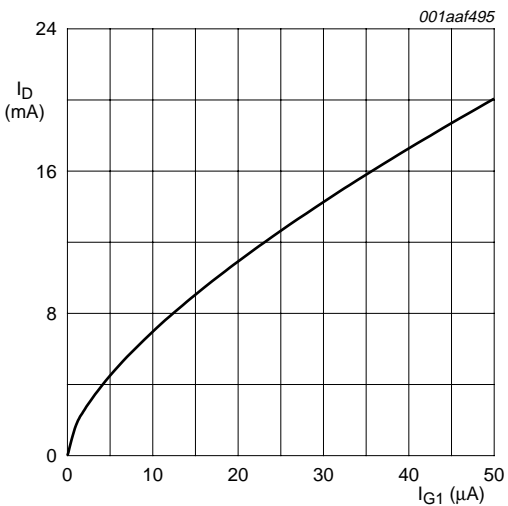

$V_{DS(B)} = 5 \text{ V}; V_{G2-S} = 4 \text{ V}; T_j = 25 \text{ }^\circ\text{C}$.

Fig 21. Amplifier B: drain current as a function of gate1 current; typical values

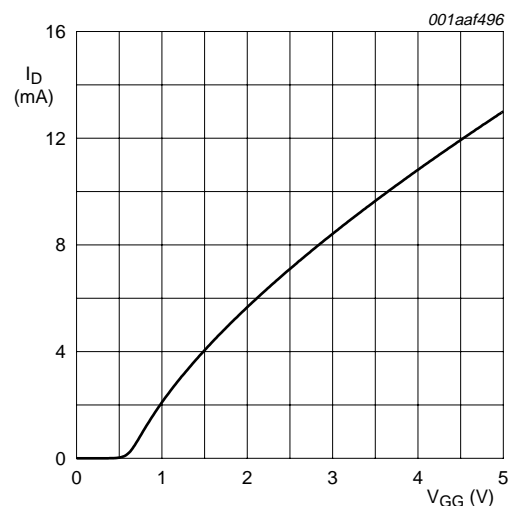

$V_{DS(B)} = 5 \text{ V}; V_{G2-S} = 4 \text{ V}; R_{G1(B)} = 150 \text{ k}\Omega;$
 $T_j = 25 \text{ }^\circ\text{C}$.

Fig 22. Amplifier B: drain voltage as a function of gate1 supply voltage (V_{GG}); typical values

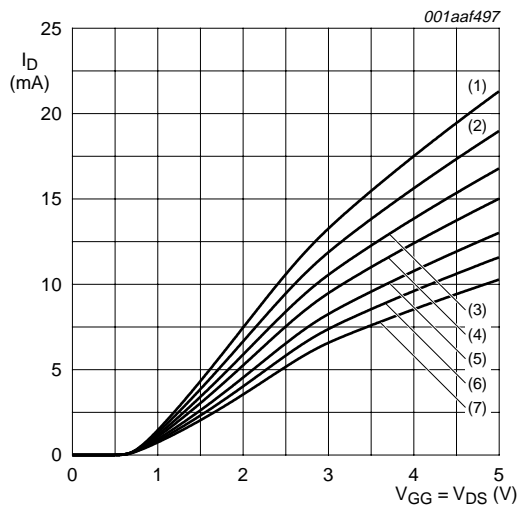

- (1) $R_{G1(B)} = 68 \text{ k}\Omega$.
 - (2) $R_{G1(B)} = 82 \text{ k}\Omega$.
 - (3) $R_{G1(B)} = 100 \text{ k}\Omega$.
 - (4) $R_{G1(B)} = 120 \text{ k}\Omega$.
 - (5) $R_{G1(B)} = 150 \text{ k}\Omega$.
 - (6) $R_{G1(B)} = 180 \text{ k}\Omega$.
 - (7) $R_{G1(B)} = 220 \text{ k}\Omega$.
- $V_{G2-S} = 5 \text{ V}$; $R_{G1(B)}$ connected to V_{GG} ; $T_j = 25 \text{ }^\circ\text{C}$.

Fig 23. Amplifier B: drain current as a function of V_{DS} and V_{GG} ; typical values

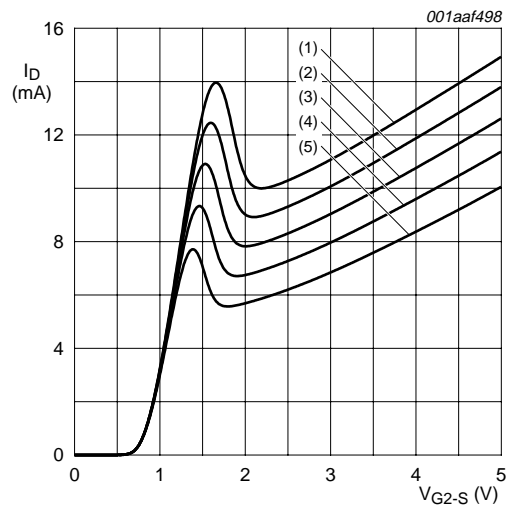

- (1) $V_{GG} = 5.0 \text{ V}$.
 - (2) $V_{GG} = 4.5 \text{ V}$.
 - (3) $V_{GG} = 4.0 \text{ V}$.
 - (4) $V_{GG} = 3.5 \text{ V}$.
 - (5) $V_{GG} = 3.0 \text{ V}$.
- $R_{G1(B)} = 150 \text{ k}\Omega$; $T_j = 25 \text{ }^\circ\text{C}$.

Fig 24. Amplifier B: drain current as a function of gate2 voltage; typical values

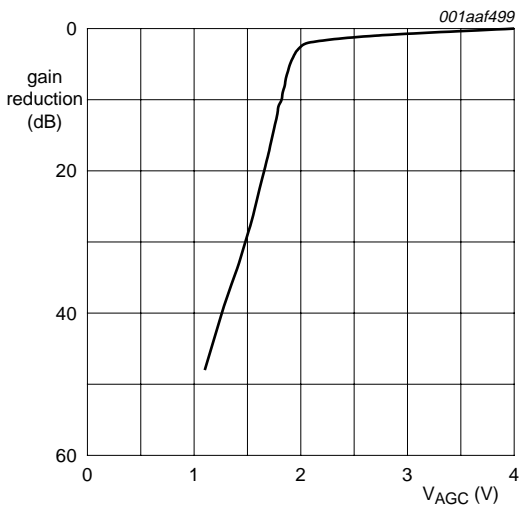

$V_{DS(B)} = 5\text{ V}$; $V_{G2-S(nom)} = 4\text{ V}$; $R_{G1(B)} = 150\text{ k}\Omega$;
 $I_{D(nom)(B)} = 13\text{ mA}$; $T_{amb} = 25\text{ }^\circ\text{C}$; see [Figure 32](#).

Fig 25. Amplifier B: typical gain reduction as a function of the AGC voltage; typical values

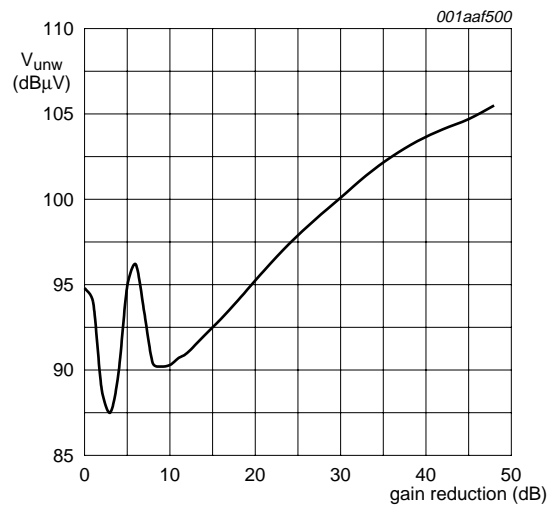

$V_{DS(B)} = 5\text{ V}$; $V_{G2-S(nom)} = 4\text{ V}$; $R_{G1(B)} = 150\text{ k}\Omega$;
 $I_{D(nom)(B)} = 13\text{ mA}$; $f_w = 50\text{ MHz}$; $f_{unw} = 60\text{ MHz}$;
 $T_{amb} = 25\text{ }^\circ\text{C}$; see [Figure 32](#).

Fig 26. Amplifier B: unwanted voltage for 1 % cross modulation as a function of gain reduction; typical values

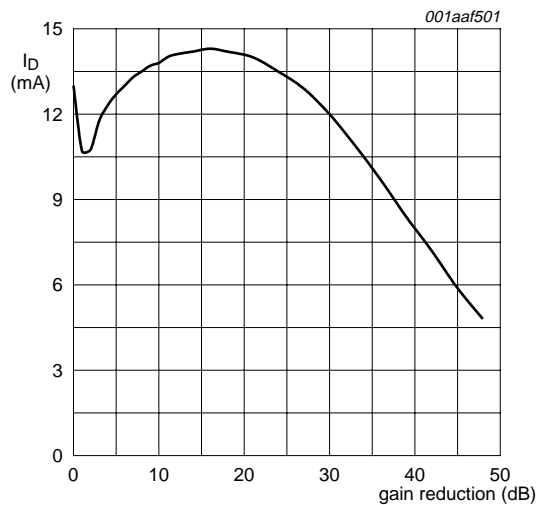

$V_{DS(B)} = V_{GG} = 5\text{ V}$; $V_{G2-S(nom)} = 4\text{ V}$; $R_{G1(B)} = 150\text{ k}\Omega$; $I_{D(nom)(B)} = 13\text{ mA}$; $f = 50\text{ MHz}$; $T_{amb} = 25\text{ }^\circ\text{C}$; see [Figure 32](#).

Fig 27. Amplifier B: typical drain current as a function of gain reduction; typical values

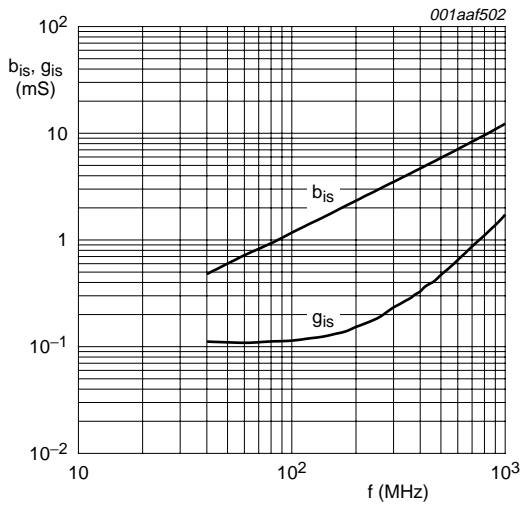

$V_{DS(B)} = 5\text{ V}; V_{G2-S} = 4\text{ V}; V_{DS(A)} = 0\text{ V};$
 $I_{D(B)} = 13\text{ mA}.$

Fig 28. Amplifier B: input admittance as a function of frequency; typical values

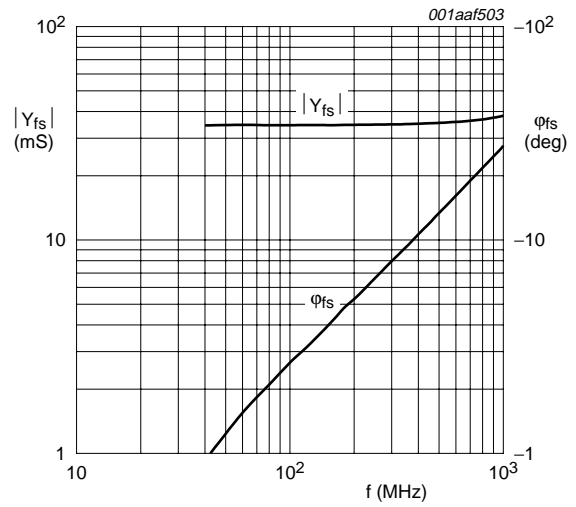

$V_{DS(B)} = 5\text{ V}; V_{G2-S} = 4\text{ V}; V_{DS(A)} = 0\text{ V};$
 $I_{D(B)} = 13\text{ mA}.$

Fig 29. Amplifier B: forward transfer admittance and phase as a function of frequency; typical values

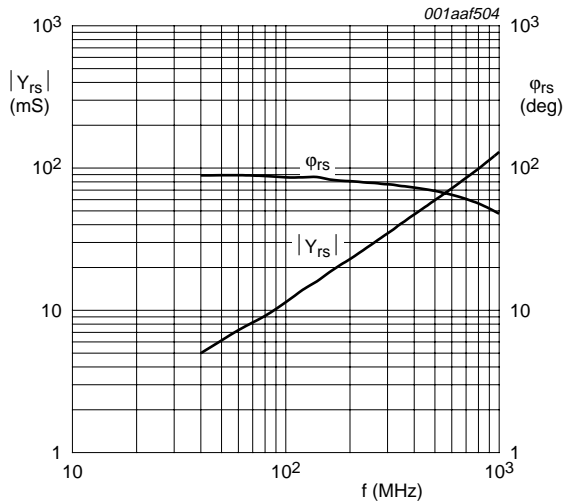

$V_{DS(B)} = 5\text{ V}; V_{G2-S} = 4\text{ V}; V_{DS(A)} = 0\text{ V};$
 $I_{D(B)} = 13\text{ mA}.$

Fig 30. Amplifier B: reverse transfer admittance and phase as a function of frequency; typical values

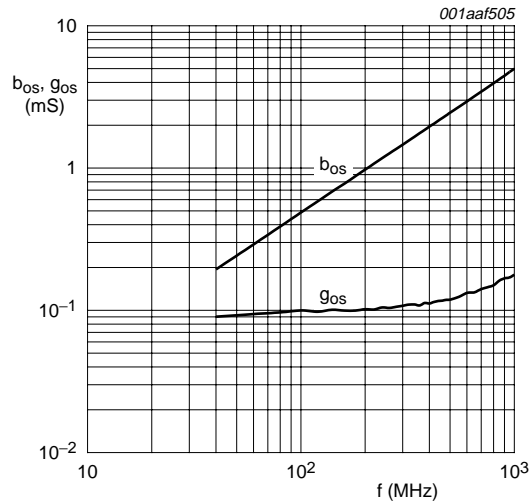

$V_{DS(B)} = 5\text{ V}; V_{G2-S} = 4\text{ V}; V_{DS(A)} = 0\text{ V};$
 $I_{D(B)} = 13\text{ mA}.$

Fig 31. Amplifier B: output admittance as a function of frequency; typical values

8.3.2 Scattering parameters for amplifier B

Table 12. Scattering parameters for amplifier B

$V_{DS(B)} = 5\text{ V}$; $V_{G2-S} = 4\text{ V}$; $I_{D(B)} = 13\text{ mA}$; $V_{DS(A)} = 0\text{ V}$; $V_{G1-S(A)} = 0\text{ V}$; $T_{amb} = 25\text{ }^\circ\text{C}$; typical values.

f (MHz)	S ₁₁		S ₂₁		S ₁₂		S ₂₂	
	Magnitude (ratio)	Angle (deg)	Magnitude (ratio)	Angle (deg)	Magnitude (ratio)	Angle (deg)	Magnitude (ratio)	Angle (deg)
40	0.9874	-2.79	3.41	177.08	0.00054	89.27	0.992	-1.26
100	0.9883	-6.8	3.41	172.57	0.00113	90.81	0.9900	-2.91
200	0.9844	-13.52	3.39	165.23	0.00224	89.67	0.9897	-5.81
300	0.9777	-20.2	3.36	157.88	0.00336	89.02	0.9889	-8.7
400	0.9684	-26.83	3.32	150.6	0.00447	88.43	0.9881	-11.61
500	0.9578	-33.32	3.27	143.38	0.0055	87.64	0.9870	-14.52
600	0.9442	-39.8	3.21	136.22	0.00649	87.53	0.9851	-17.39
700	0.9291	-46.08	3.16	129.15	0.00741	87.51	0.9838	-20.3
800	0.9147	-52.18	3.08	122.25	0.00828	87.7	0.9825	-23.2
900	0.9002	-58.35	3.08	115.4	0.00914	88.14	0.9803	-26.06
1000	0.8836	-64.49	2.93	108.49	0.00997	88.26	0.9789	-29.03

8.4 Noise data for amplifier B

Table 13. Noise data for amplifier B

$V_{DS(B)} = 5\text{ V}$; $V_{G2-S} = 4\text{ V}$; $I_{D(B)} = 13\text{ mA}$; $T_{amb} = 25\text{ }^\circ\text{C}$; typical values.

f (MHz)	NF _{min} (dB)	Γ _{opt}		r _n (ratio)
		(ratio)	(deg)	
400	0.9	0.743	20.27	0.65
800	1.2	0.687	42.08	0.581

9. Test information

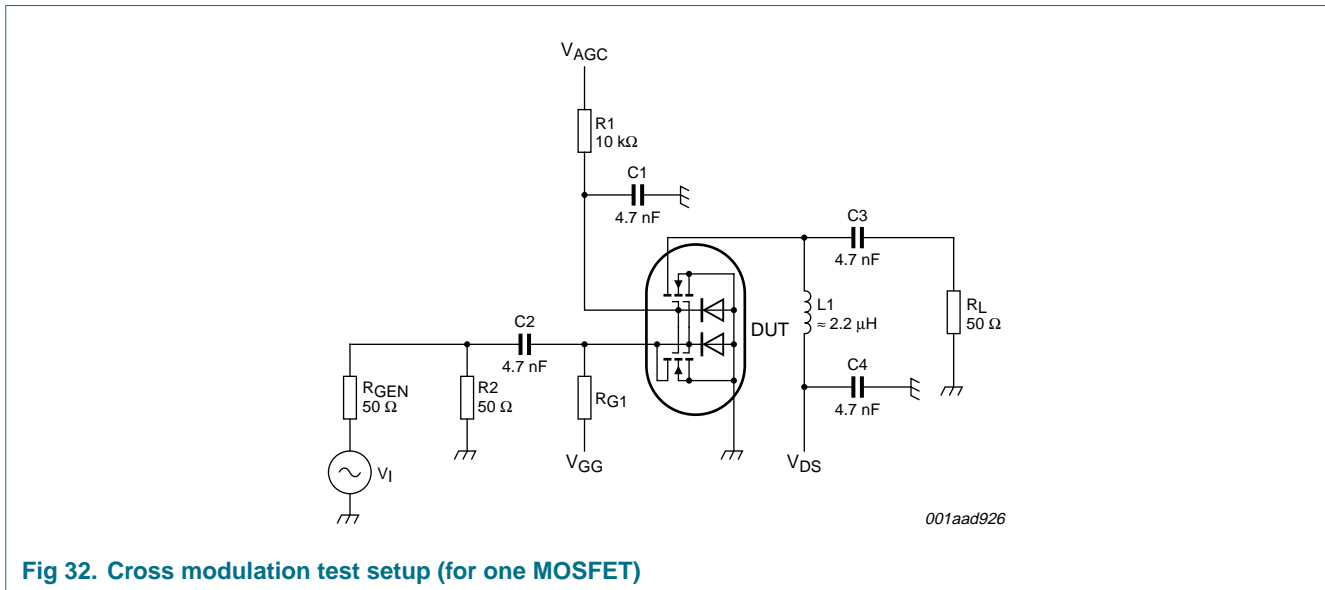

Fig 32. Cross modulation test setup (for one MOSFET)

10. Package outline

Plastic surface-mounted package; 6 leads

SOT363

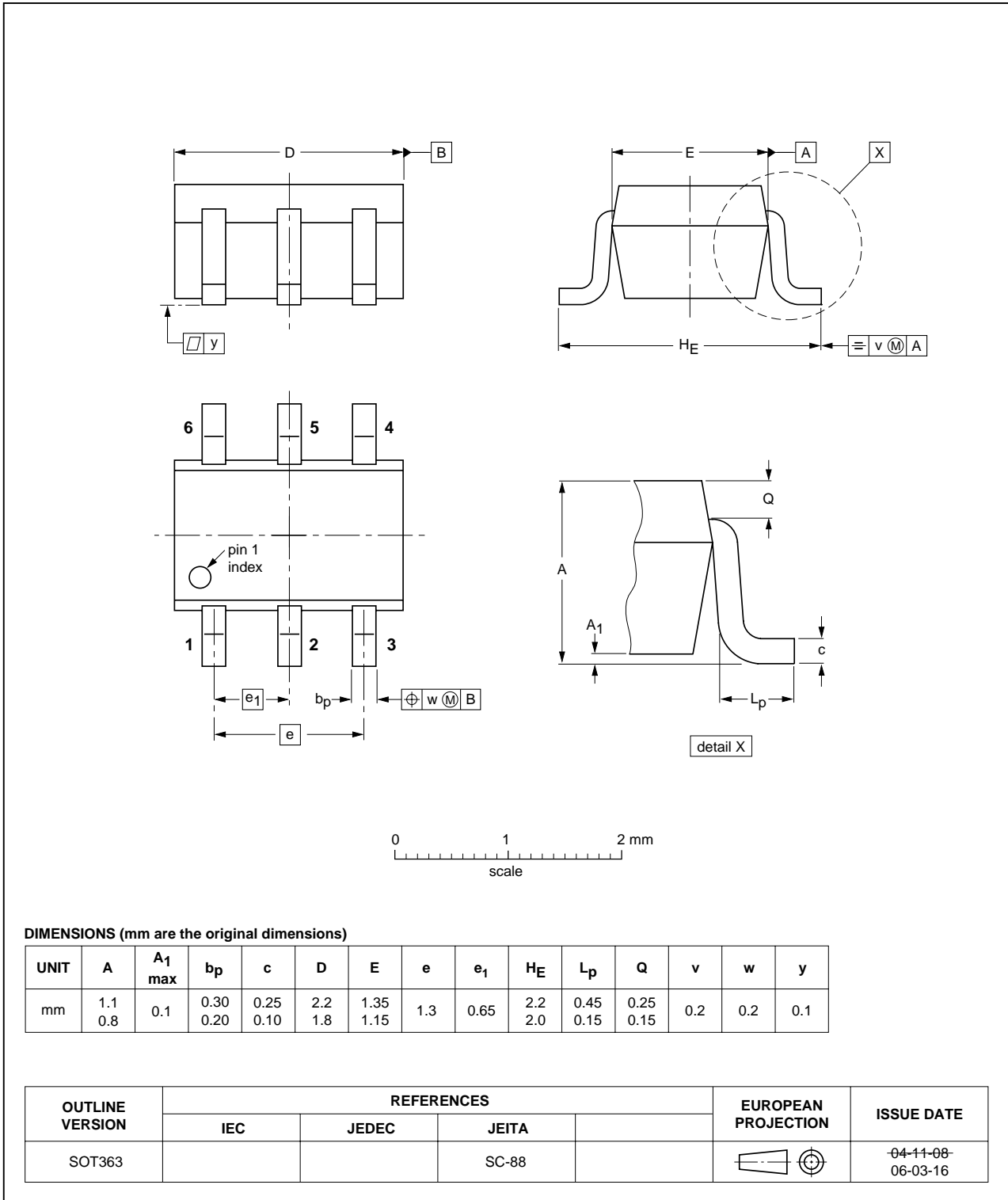

Fig 33. Package outline SOT363

11. Abbreviations

Table 14. Abbreviations

Acronym	Description
AGC	Automatic Gain Control
DC	Direct Current
MOSFET	Metal-Oxide-Semiconductor Field-Effect Transistor
UHF	Ultra High Frequency
VHF	Very High Frequency

12. Revision history

Table 15. Revision history

Document ID	Release date	Data sheet status	Change notice	Supersedes
BF1210_1	20061025	Product data sheet	-	-

13. Legal information

13.1 Data sheet status

Document status ^{[1][2]}	Product status ^[3]	Definition
Objective [short] data sheet	Development	This document contains data from the objective specification for product development.
Preliminary [short] data sheet	Qualification	This document contains data from the preliminary specification.
Product [short] data sheet	Production	This document contains the product specification.

[1] Please consult the most recently issued document before initiating or completing a design.

[2] The term 'short data sheet' is explained in section "Definitions".

[3] The product status of device(s) described in this document may have changed since this document was published and may differ in case of multiple devices. The latest product status information is available on the Internet at URL <http://www.nxp.com>.

13.2 Definitions

Draft — The document is a draft version only. The content is still under internal review and subject to formal approval, which may result in modifications or additions. NXP Semiconductors does not give any representations or warranties as to the accuracy or completeness of information included herein and shall have no liability for the consequences of use of such information.

Short data sheet — A short data sheet is an extract from a full data sheet with the same product type number(s) and title. A short data sheet is intended for quick reference only and should not be relied upon to contain detailed and full information. For detailed and full information see the relevant full data sheet, which is available on request via the local NXP Semiconductors sales office. In case of any inconsistency or conflict with the short data sheet, the full data sheet shall prevail.

13.3 Disclaimers

General — Information in this document is believed to be accurate and reliable. However, NXP Semiconductors does not give any representations or warranties, expressed or implied, as to the accuracy or completeness of such information and shall have no liability for the consequences of use of such information.

Right to make changes — NXP Semiconductors reserves the right to make changes to information published in this document, including without limitation specifications and product descriptions, at any time and without notice. This document supersedes and replaces all information supplied prior to the publication hereof.

Suitability for use — NXP Semiconductors products are not designed, authorized or warranted to be suitable for use in medical, military, aircraft, space or life support equipment, nor in applications where failure or

malfunction of a NXP Semiconductors product can reasonably be expected to result in personal injury, death or severe property or environmental damage. NXP Semiconductors accepts no liability for inclusion and/or use of NXP Semiconductors products in such equipment or applications and therefore such inclusion and/or use is at the customer's own risk.

Applications — Applications that are described herein for any of these products are for illustrative purposes only. NXP Semiconductors makes no representation or warranty that such applications will be suitable for the specified use without further testing or modification.

Limiting values — Stress above one or more limiting values (as defined in the Absolute Maximum Ratings System of IEC 60134) may cause permanent damage to the device. Limiting values are stress ratings only and operation of the device at these or any other conditions above those given in the Characteristics sections of this document is not implied. Exposure to limiting values for extended periods may affect device reliability.

Terms and conditions of sale — NXP Semiconductors products are sold subject to the general terms and conditions of commercial sale, as published at <http://www.nxp.com/profile/terms>, including those pertaining to warranty, intellectual property rights infringement and limitation of liability, unless explicitly otherwise agreed to in writing by NXP Semiconductors. In case of any inconsistency or conflict between information in this document and such terms and conditions, the latter will prevail.

No offer to sell or license — Nothing in this document may be interpreted or construed as an offer to sell products that is open for acceptance or the grant, conveyance or implication of any license under any copyrights, patents or other industrial or intellectual property rights.

13.4 Trademarks

Notice: All referenced brands, product names, service names and trademarks are the property of their respective owners.

14. Contact information

For additional information, please visit: <http://www.nxp.com>

For sales office addresses, send an email to: salesaddresses@nxp.com

15. Contents

1	Product profile	1
1.1	General description	1
1.2	Features	1
1.3	Applications	1
1.4	Quick reference data	2
2	Pinning information	2
3	Ordering information	2
4	Marking	3
5	Limiting values	3
6	Thermal characteristics	4
7	Static characteristics	4
8	Dynamic characteristics	4
8.1	Dynamic characteristics for amplifier A	4
8.1.1	Graphs for amplifier A	6
8.1.2	Scattering parameters for amplifier A	11
8.2	Noise data for amplifier A	11
8.3	Dynamic characteristics for amplifier B	11
8.3.1	Graphs for amplifier B	12
8.3.2	Scattering parameters for amplifier B	17
8.4	Noise data for amplifier B	17
9	Test information	17
10	Package outline	18
11	Abbreviations	19
12	Revision history	19
13	Legal information	20
13.1	Data sheet status	20
13.2	Definitions	20
13.3	Disclaimers	20
13.4	Trademarks	20
14	Contact information	20
15	Contents	21

Please be aware that important notices concerning this document and the product(s) described herein, have been included in section 'Legal information'.



© NXP B.V. 2006.

All rights reserved.

For more information, please visit: <http://www.nxp.com>

For sales office addresses, please send an email to: salesaddresses@nxp.com

Date of release: 25 October 2006

Document identifier: BF1210_1