

## SIKOREL®

### Applications

- Excellent reliable design for automotive applications

### Features

- High operating temperature capability
- Low ESR
- Extremely high reliability
- Outstanding parametric stability
- High ripple current capability
- High vibration resistance
- Long useful life
- Shelf life up to 15 years

### Construction

- Charge-discharge proof, polar
- Aluminum case with insulating sleeve
- Negative pole connected to case

### Terminals

- Axial leads, welded to ensure perfect electrical contact
- Also available with soldering stars

### Taping and packing

- Axial-lead capacitors will be delivered in pallet package.  
Capacitors with  $d \times l \leq 16 \times 30$  mm are also available taped on reel.
- Solder-star capacitors are packed in cardboard.

For details on taping and packing, refer to page 342.

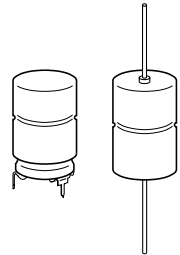

KAL0573-K

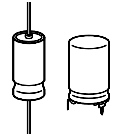
**Specifications and characteristics in brief**

Rated voltage $U_R$	25 ... 100 VDC					
Surge voltage $U_S$	$1,15 \cdot U_R$					
Rated capacitance $C_R$	100 ... 1 500 $\mu\text{F}$					
Capacitance tolerance	- 10/+ 30 % $\triangleq$ Q					
Leakage current $I_L$ (5 min, 20 °C)	$I_L \leq 0,006 \mu\text{A} \cdot \left( \frac{C_R}{\mu\text{F}} \cdot \frac{U_R}{\text{V}} \right) + 4 \mu\text{A}$					
Self-inductance $ESL^{1)}$	Diameter $d$	12 mm	14 mm	16 mm	18 mm	
	Length $l$	Terminal	Approx. $ESL$ (nH)			
	25 mm	axial / solder star	— / —	22 / 6	26 / 7	— / —
	30 mm	axial / solder star	21 / 6	24 / 7	29 / 8	34 / 10
	39 mm	axial / solder star	— / —	— / —	33 / 9	38 / 11
Useful life 150 °C; $U_R$ ; 0,5 $I_{-R}$ 125 °C; $U_R$ ; $I_{-R}$ 85 °C; $U_R$ ; $I_{-max}$ 40 °C; $U_R$ ; 2,1 $\cdot I_{-R}$	25...90 VDC	100 VDC	Requirements: $\Delta C/C \leq \pm 30$ % of initial value $ESR \leq 3$ times of initial specified limit $I_L \leq$ initial specified limit Failure percentage: $\leq 0,5$ % Failure rate: $\leq 10$ fit ( $\leq 10 \cdot 10^{-9}/\text{h}$ ) (for definiton "fit", refer to chapter "Quality", page 62)			
	> 1 000 h	> 1 000 h <sup>*)</sup>				
	> 5 000 h	> 3 000 h				
	> 15 000 h	> 8 000 h				
	> 200 000 h	> 200 000 h				
	*) for 140 °C					
Voltage endurance test 125 °C; $U_R$	2 000 h		Post test requirements:			
			$\Delta C/C \leq \pm 10$ % of initial value $ESR \leq 1,3$ % of initial specified limit $I_L \leq$ initial specified limit			
Vibration resistance	To IEC 60068-2-6, test Fc: displacement amplitude 1,5 mm, at 10 Hz to 2 kHz, acceleration max. 20 g, duration $3 \times 2$ h					
IEC climatic category	To IEC 60068-1: 55/125/56 (-55 °C/+125 °C/56 days damp heat test)					
Detail specification	Similar to CECC 30301-802					
Sectional specification	IEC 60384-4					

1) If optimum circuit design is used, the values are lower by 30 %.

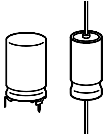

B41693 / B41793

Up to 150 °C

## Dimensional drawings

### Axial-lead capacitor

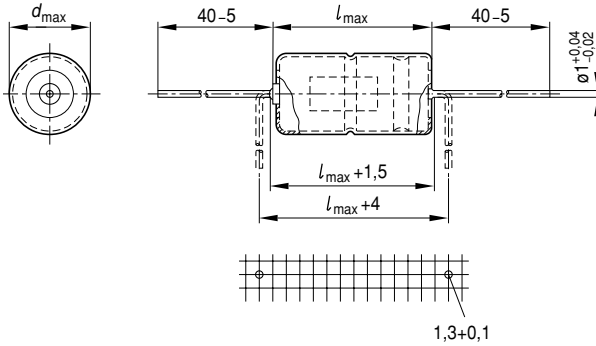

KAL0524-S

### Dimensions, weights and packing units

$d \times l$ mm	$d_{\max} \times l_{\max}$ mm	Approx. weight g	Packing units (pieces)	
			Pallet	Reel
12 × 30	12,5 × 30,5	5,1	288	450
14 × 25	14,5 × 25,5	5,7	200	350
14 × 30	14,5 × 30,5	6,8	200	350
16 × 25	16,5 × 25,5	7,4	180	250
16 × 30	16,5 × 30,5	8,9	180	250
16 × 39	16,5 × 40	11,7	180	—
18 × 30	18,5 × 30,5	11,1	160	—
18 × 39	18,5 × 40	14,7	160	—

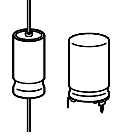

### Soldering star capacitors

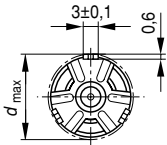

Mounting holes  
 $d = 12 \text{ mm} \dots 14 \text{ mm}$

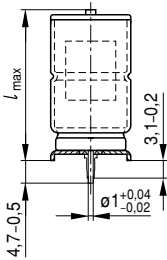
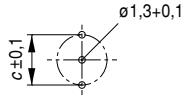

Mounting holes  
 $d = 16 \text{ mm} \dots 18 \text{ mm}$

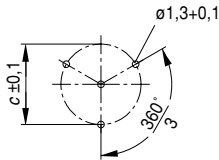

Soldering star is connected to the negative pole

KAL0525-1-E

The PC-board hole arrangement specified above is based on circular arcs.

If, however, the mounting holes have to be matched to a standard drilling raster, a spacing of 1,27 mm ( $1/20''$ ) has proved to be sufficiently accurate if the following arrangements are used:

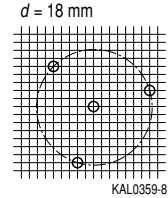
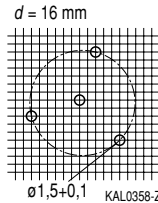
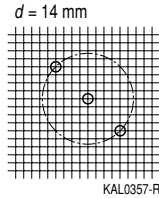
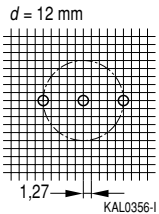

### Dimensions, weights and packing units

$d \times l$ mm	$d_{\text{max}} \times l_{\text{max}}$ mm	$c \pm 0,1$ mm	Approx. weight g	Packing units pieces
12 × 30	13,5 × 32	12,5	5,4	480
14 × 25	15,5 × 27	14,5	6,1	480
14 × 30	15,5 × 32	14,5	7,2	480
16 × 25	17,5 × 27	16,5	7,9	300
16 × 30	17,5 × 32	16,5	9,4	300
16 × 39	17,5 × 41,5	16,5	12,2	200
18 × 30	19,5 × 32	18,5	11,8	300
18 × 39	19,5 × 41,5	18,5	15,4	200

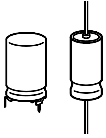
**B41693 / B41793**
**Up to 150 °C**
**Overview of available types**

$U_R$ (VDC)	25	40	63	75	100
$C_R$ ( $\mu$ F)	Case dimensions $d \times l$ (mm)				
100			12 × 30	12 × 30	14 × 25
150					16 × 25
220			14 × 30	16 × 30	
330		12 × 30			18 × 39
470	14 × 25		16 × 39	18 × 39	
1 000	16 × 30	18 × 30			
1 500	16 × 39	18 × 39			

**Case dimensions and ordering codes**

$U_R$ VDC	$C_R$ $\mu$ F	Case dim. $d \times l$ mm	Ordering code		
			Axial pallet package	Axial reel	Soldering star
25	470	14 × 25	B41693A5477Q007	B41693A5477Q009	B41793A5477Q000
	1 000	16 × 30	B41693A5108Q007	B41693A5108Q009	B41793A5108Q000
	1 500	16 × 39	B41693A5158Q007		B41793A5158Q000
40	330	12 × 30	B41693A7337Q007	B41693A7337Q009	B41793A7337Q000
	1 000	18 × 30	B41693A7108Q007		B41793A7108Q000
	1 500	18 × 39	B41693A7158Q007		B41793A7158Q000
63	100	12 × 30	B41693A8107Q007	B41693A8107Q009	B41793A8107Q000
	220	14 × 30	B41693A8227Q007	B41693A8277Q009	B41793A8227Q000
	470	16 × 39	B41693A8477Q007		B41793A8477Q000
75	100	12 × 30	B41693A0107Q007	B41693A0107Q009	B41793A0107Q000
	220	16 × 30	B41693A0227Q007	B41693A0227Q009	B41793A0227Q000
	470	18 × 39	B41693A0477Q007		B41793A0477Q000
100	100	14 × 25	B41693A9107Q007	B41693A9107Q009	B41793A9107Q000
	150	16 × 25	B41693A9157Q007	B41693A9157Q009	B41793A9157Q000
	330	18 × 39	B41693A9337Q007		B41793A9337Q000

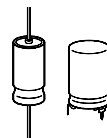
**Technical data**

$C_R$	$ESR_{typ}$	$ESR_{max}$	$ESR_{max}$	$ESR_{max}$	$Z_{max}$	$I_{\sim max}$	$I_{\sim max}$	$I_{\sim R}$	$I_{\sim max}$
100 Hz	100 Hz	100 Hz	100 Hz	10 kHz	100 kHz	10 kHz	10 kHz	10 kHz	10 kHz
20 °C	20 °C	20 °C	-40 °C	20 °C	20 °C	40 °C	85 °C	125 °C	150 °C
$\mu F$	m $\Omega$	m $\Omega$	$\Omega$	m $\Omega$	m $\Omega$	A	A	A	A
<b>25 VDC</b>									
470	200	320	1,90	190	180	3,80	3,55	1,60	0,80
1 000	90	150	0,90	100	92	6,00	5,50	2,50	1,25
1 500	60	100	0,60	70	65	8,30	7,70	3,45	1,72
<b>40 VDC</b>									
330	250	400	2,50	200	190	3,80	3,55	1,60	0,80
1 000	80	130	0,70	80	76	7,60	6,10	2,75	1,37
1 500	55	90	0,50	55	52	9,20	8,50	3,80	1,90
<b>63 VDC</b>									
100	500	800	3,30	280	270	3,30	3,00	1,35	0,67
220	230	380	1,70	135	130	4,90	4,60	2,05	1,02
470	110	170	0,90	68	65	8,20	7,60	3,40	1,70
<b>75 VDC</b>									
100	420	700	3,00	225	220	3,60	3,35	1,50	0,75
220	200	330	1,50	115	110	5,70	5,20	2,35	1,17
470	90	150	0,70	60	56	9,20	8,50	3,80	1,90
<b>100 VDC</b>									
100	430	900	3,40	300	270	3,80	3,30	1,45	—
150	280	550	2,10	200	180	4,65	4,00	1,75	—
330	120	250	1,00	90	80	8,80	7,60	3,35	—

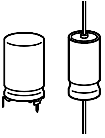

B41693 / B41793

Up to 150 °C

### Useful life

depending on ambient temperature  $T_A$  under ripple current operating conditions<sup>1)</sup>

$U_R < 100\text{ V}$  or  $U_R = 100\text{ V}$  and operating voltage  $U_{op} \leq 90\text{ V}$

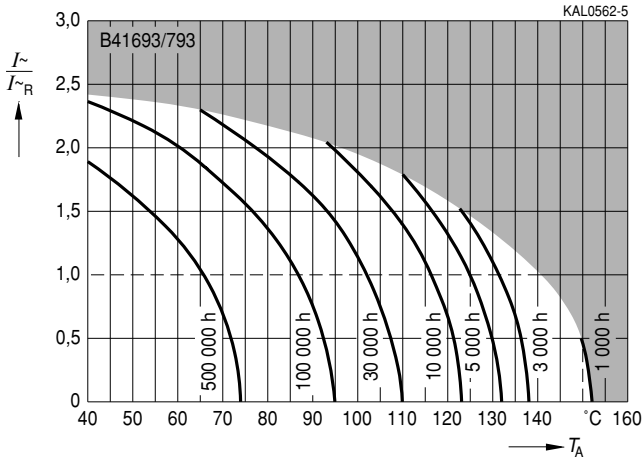

### Useful life

depending on case temperature  $T_C$  under ripple current operating conditions<sup>1)</sup>

$U_R < 100\text{ V}$  or  $U_R = 100\text{ V}$  and operating voltage  $U_{op} \leq 90\text{ V}$

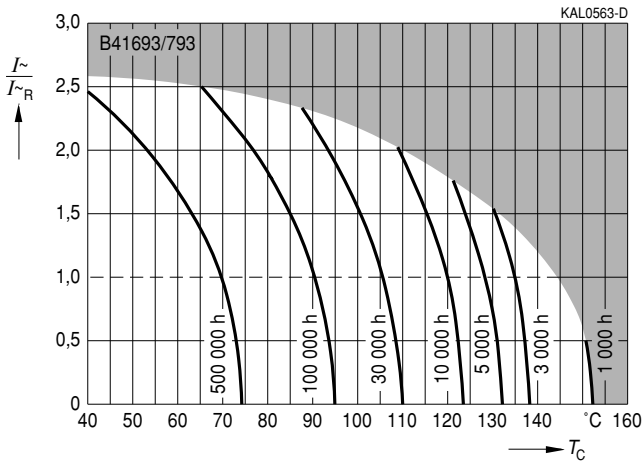

1) Refer to page 40 for an explanation on how to interpret the useful life graphs.

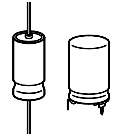

**Useful life**

depending on temperature  $T_A$  under ripple current operating conditions<sup>1)</sup>

$U_R = 100\text{ V}$

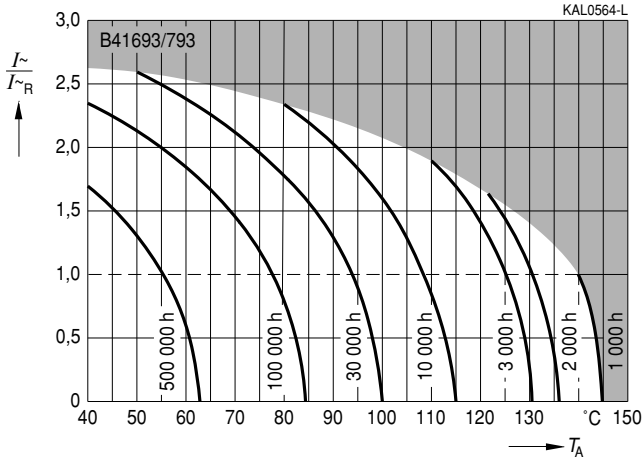

**Useful life**

depending on case temperature  $T_C$  under ripple current operating conditions<sup>1)</sup>

$U_R = 100\text{ V}$

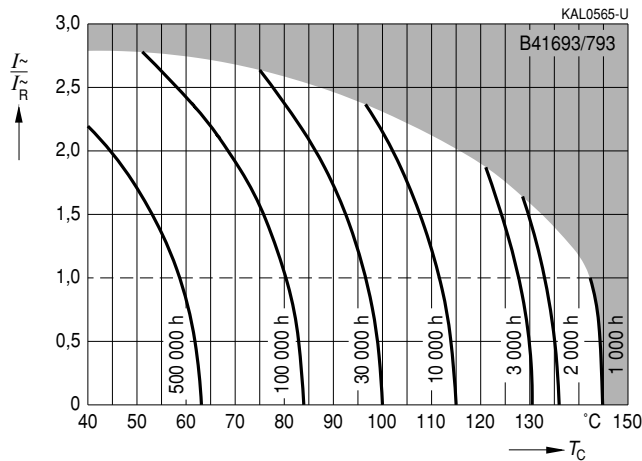

1) Refer to page 40 for an explanation on how to interpret the useful life graphs.



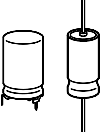

**B41693 / B41793**  
**Up to 150 °C**

**Frequency factor of permissible ripple current  $I_r$  versus frequency  $f$**

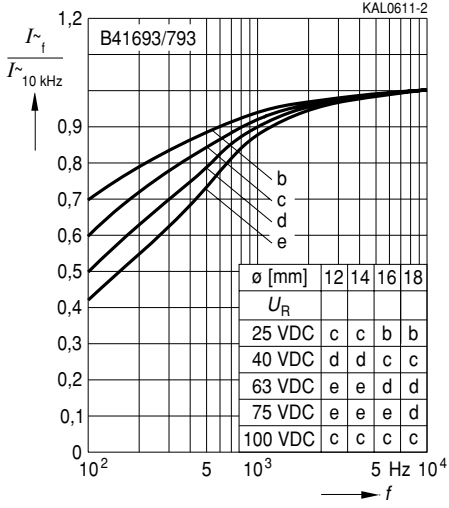

**Frequency characteristics of ESR at different temperatures**  
 Typical behavior

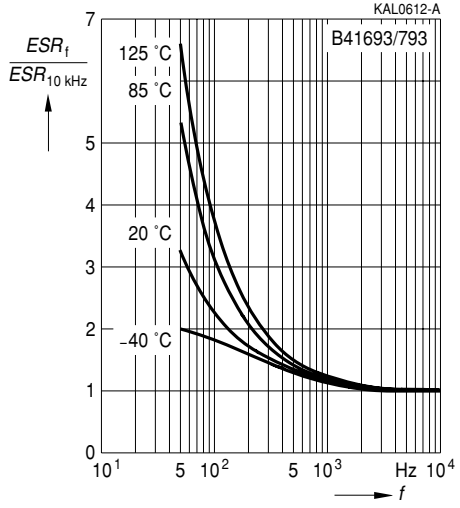

**Equivalent series resistance ESR versus frequency  $f$  at different temperatures**  
 Typical behavior for 470  $\mu$ F/63 V

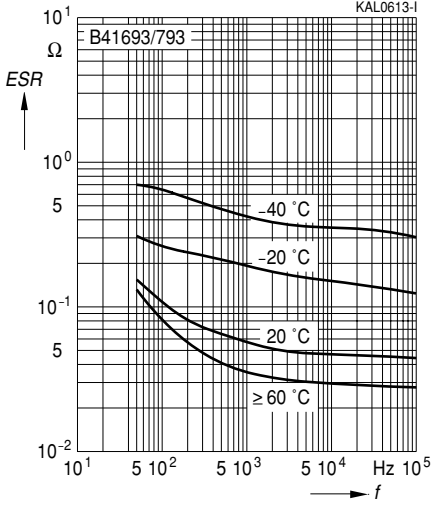

**Impedance Z versus frequency  $f$  at different temperatures**  
 Typical behavior for 470  $\mu$ F/63 V

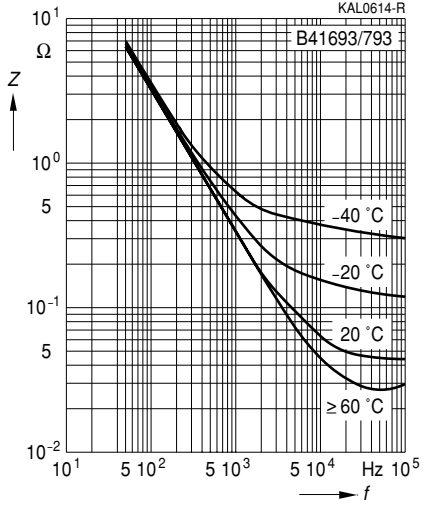

**Herausgegeben von EPCOS AG**

**Unternehmenskommunikation, Postfach 80 17 09, 81617 München, DEUTSCHLAND**

**☎ ++49 89 636 09, FAX (0 89) 636-2 26 89**

© EPCOS AG 2002. Vervielfältigung, Veröffentlichung, Verbreitung und Verwertung dieser Broschüre und ihres Inhalts ohne ausdrückliche Genehmigung der EPCOS AG nicht gestattet.

Bestellungen unterliegen den vom ZVEI empfohlenen Allgemeinen Lieferbedingungen für Erzeugnisse und Leistungen der Elektroindustrie, soweit nichts anderes vereinbart wird.

Diese Broschüre ersetzt die vorige Ausgabe.

Fragen über Technik, Preise und Liefermöglichkeiten richten Sie bitte an den Ihnen nächstgelegenen Vertrieb der EPCOS AG oder an unsere Vertriebsgesellschaften im Ausland. Bauelemente können aufgrund technischer Erfordernisse Gefahrstoffe enthalten. Auskünfte darüber bitten wir unter Angabe des betreffenden Typs ebenfalls über die zuständige Vertriebsgesellschaft einzuholen.

**Published by EPCOS AG**

**Corporate Communications, P.O. Box 80 17 09, 81617 Munich, GERMANY**

**☎ ++49 89 636 09, FAX (0 89) 636-2 26 89**

© EPCOS AG 2002. Reproduction, publication and dissemination of this brochure and the information contained therein without EPCOS' prior express consent is prohibited.

Purchase orders are subject to the General Conditions for the Supply of Products and Services of the Electrical and Electronics Industry recommended by the ZVEI (German Electrical and Electronic Manufacturers' Association), unless otherwise agreed.

This brochure replaces the previous edition.

For questions on technology, prices and delivery please contact the Sales Offices of EPCOS AG or the international Representatives.

Due to technical requirements components may contain dangerous substances. For information on the type in question please also contact one of our Sales Offices.