

POWER MOS V®

Power MOS V® is a new generation of high voltage N-Channel enhancement mode power MOSFETs. This new technology minimizes the JFET effect, increases packing density and reduces the on-resistance. Power MOS V® also achieves faster switching speeds through optimized gate layout.

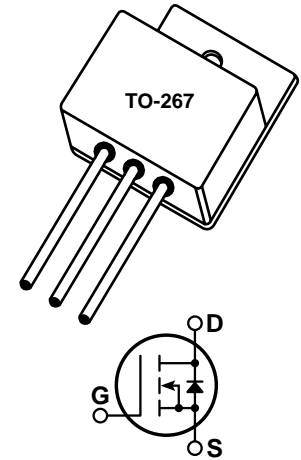

- **Faster Switching**
- **100% Avalanche Tested**
- **Lower Leakage**
- **New TO-267 Package**

MAXIMUM RATINGS

All Ratings: $T_C = 25^\circ\text{C}$ unless otherwise specified.

Symbol	Parameter	APT6017WVR	UNIT
V_{DSS}	Drain-Source Voltage	600	Volts
I_D	Continuous Drain Current @ $T_C = 25^\circ\text{C}$	31.5	Amps
I_{DM}	Pulsed Drain Current ^①	126	
V_{GS}	Gate-Source Voltage Continuous	± 30	Volts
V_{GSM}	Gate-Source Voltage Transient	± 40	
P_D	Total Power Dissipation @ $T_C = 25^\circ\text{C}$	450	Watts
	Linear Derating Factor	3.6	W/°C
T_J, T_{STG}	Operating and Storage Junction Temperature Range	-55 to 150	°C
T_L	Lead Temperature: 0.063" from Case for 10 Sec.	300	
I_{AR}	Avalanche Current ^① (Repetitive and Non-Repetitive)	31.5	Amps
E_{AR}	Repetitive Avalanche Energy ^①	50	mJ
E_{AS}	Single Pulse Avalanche Energy ^④	2500	

STATIC ELECTRICAL CHARACTERISTICS

Symbol	Characteristic / Test Conditions	MIN	TYP	MAX	UNIT
BV_{DSS}	Drain-Source Breakdown Voltage ($V_{GS} = 0V, I_D = 250\mu\text{A}$)	600			Volts
$I_{D(on)}$	On State Drain Current ^② ($V_{DS} > I_{D(on)} \times R_{DS(on)}$ Max, $V_{GS} = 10V$)	31.5			Amps
$R_{DS(on)}$	Drain-Source On-State Resistance ^② ($V_{GS} = 10V, 0.5 I_{D[Cont.]}$)			0.170	Ohms
I_{DSS}	Zero Gate Voltage Drain Current ($V_{DS} = V_{DSS}, V_{GS} = 0V$)			25	μA
	Zero Gate Voltage Drain Current ($V_{DS} = 0.8 V_{DSS}, V_{GS} = 0V, T_C = 125^\circ\text{C}$)			250	
I_{GSS}	Gate-Source Leakage Current ($V_{GS} = \pm 30V, V_{DS} = 0V$)			± 100	nA
$V_{GS(th)}$	Gate Threshold Voltage ($V_{DS} = V_{GS}, I_D = 2.5\text{mA}$)	2		4	Volts

 **CAUTION:** These Devices are Sensitive to Electrostatic Discharge. Proper Handling Procedures Should Be Followed.

USA
405 S.W. Columbia Street

EUROPE
Avenue J.F. Kennedy Bât B4 Parc Cadéra Nord

APT Website - <http://www.advancedpower.com>

Bend, Oregon 97702-1035

Phone: (541) 382-8028

FAX: (541) 388-0364

F-33700 Merignac - France

Phone: (33) 5 57 92 15 15

FAX: (33) 5 56 47 97 61

DYNAMIC CHARACTERISTICS

APT6017WVR

Symbol	Characteristic	Test Conditions	MIN	TYP	MAX	UNIT
C_{iss}	Input Capacitance	$V_{GS} = 0V$ $V_{DS} = 25V$ $f = 1 \text{ MHz}$		7500	9000	pF
C_{oss}	Output Capacitance			900	1260	
C_{rss}	Reverse Transfer Capacitance			320	480	
Q_g	Total Gate Charge ③	$V_{GS} = 10V$ $V_{DD} = 0.5 V_{DSS}$ $I_D = I_{D[Cont.]} @ 25^\circ C$		315	475	nC
Q_{gs}	Gate-Source Charge			45	70	
Q_{gd}	Gate-Drain ("Miller") Charge			125	190	
$t_{d(on)}$	Turn-on Delay Time	$V_{GS} = 15V$ $V_{DD} = 0.5 V_{DSS}$ $I_D = I_{D[Cont.]} @ 25^\circ C$ $R_G = 0.6\Omega$		15	30	ns
t_r	Rise Time			13	26	
$t_{d(off)}$	Turn-off Delay Time			45	70	
t_f	Fall Time			5	10	

SOURCE-DRAIN DIODE RATINGS AND CHARACTERISTICS

Symbol	Characteristic / Test Conditions	MIN	TYP	MAX	UNIT
I_S	Continuous Source Current (Body Diode)			31.5	Amps
I_{SM}	Pulsed Source Current ① (Body Diode)			126	
V_{SD}	Diode Forward Voltage ② ($V_{GS} = 0V, I_S = -I_{D[Cont.]}$)			1.3	Volts
t_{rr}	Reverse Recovery Time ($I_S = -I_{D[Cont.]}, di_S/dt = 100A/\mu s$)		690		ns
Q_{rr}	Reverse Recovery Charge ($I_S = -I_{D[Cont.]}, di_S/dt = 100A/\mu s$)		15.9		μC

THERMAL CHARACTERISTICS

Symbol	Characteristic	MIN	TYP	MAX	UNIT
$R_{\theta JC}$	Junction to Case			0.28	$^\circ C/W$
$R_{\theta JA}$	Junction to Ambient			40	

① Repetitive Rating: Pulse width limited by maximum junction temperature.

③ See MIL-STD-750 Method 3471

② Pulse Test: Pulse width < 380 μs , Duty Cycle < 2%

④ Starting $T_j = +25^\circ C$, $L = 5.04mH$, $R_G = 25\Omega$, Peak $I_L = 31.5A$

APT Reserves the right to change, without notice, the specifications and information contained herein.

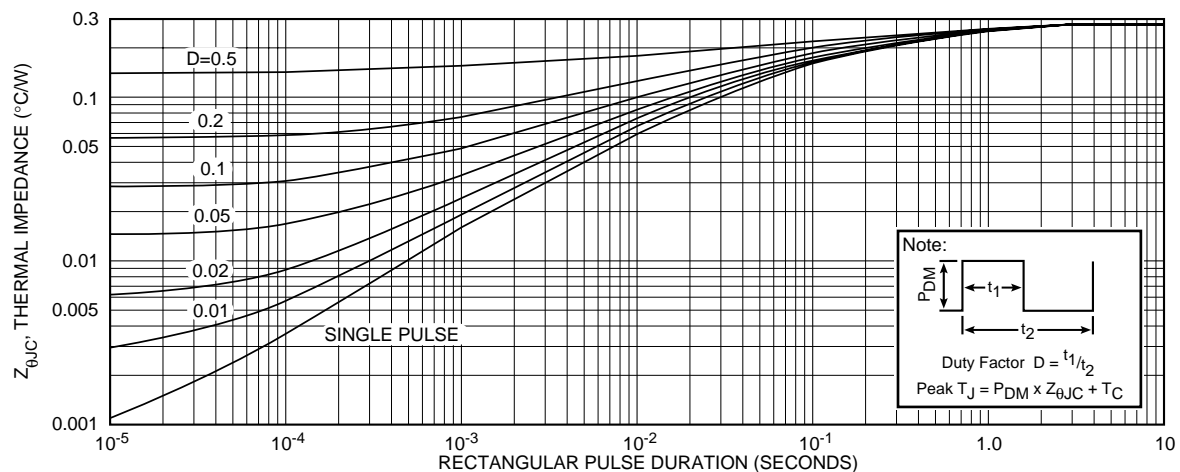

FIGURE 1, MAXIMUM EFFECTIVE TRANSIENT THERMAL IMPEDANCE, JUNCTION-TO-CASE vs PULSE DURATION

APT6017WVR

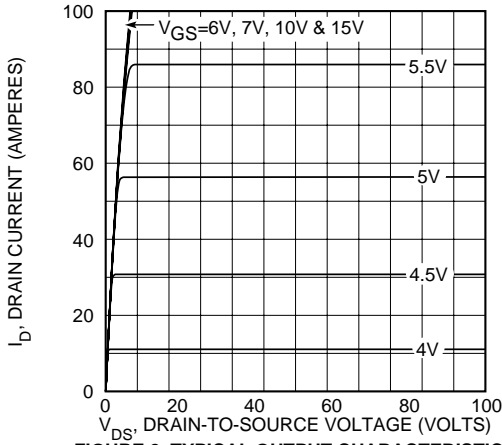

FIGURE 2, TYPICAL OUTPUT CHARACTERISTICS

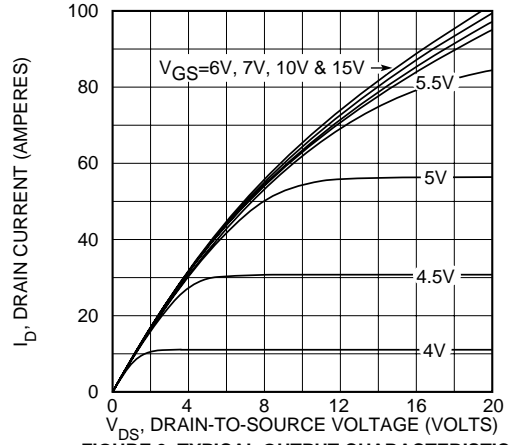

FIGURE 3, TYPICAL OUTPUT CHARACTERISTICS

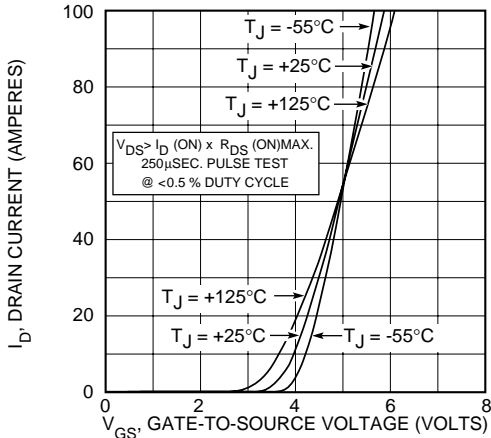

FIGURE 4, TYPICAL TRANSFER CHARACTERISTICS

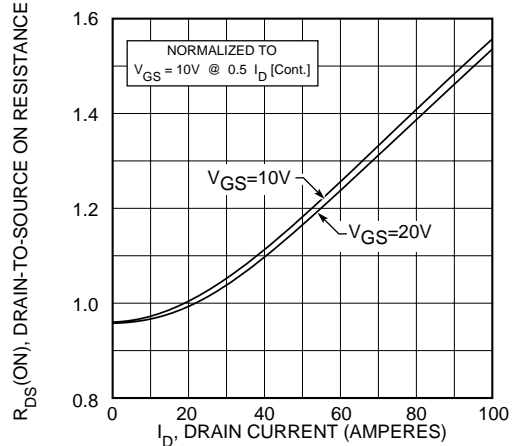

FIGURE 5, $R_{DS(ON)}$ vs DRAIN CURRENT

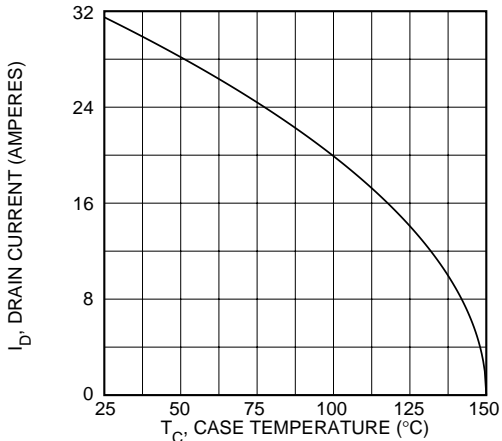

FIGURE 6, MAXIMUM DRAIN CURRENT vs CASE TEMPERATURE

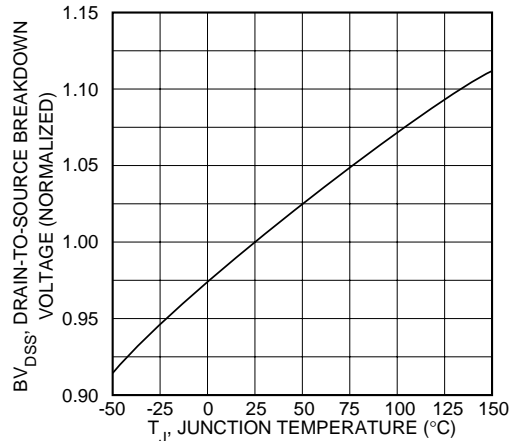

FIGURE 7, BREAKDOWN VOLTAGE vs TEMPERATURE

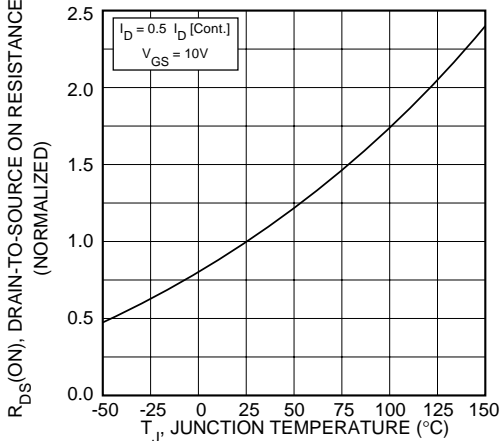

FIGURE 8, ON-RESISTANCE vs. TEMPERATURE

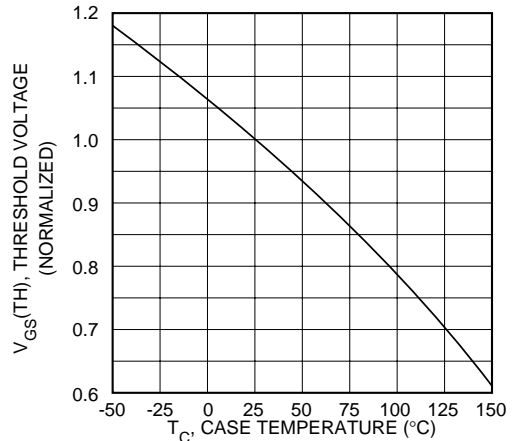

FIGURE 9, THRESHOLD VOLTAGE vs TEMPERATURE

APT6017WVR

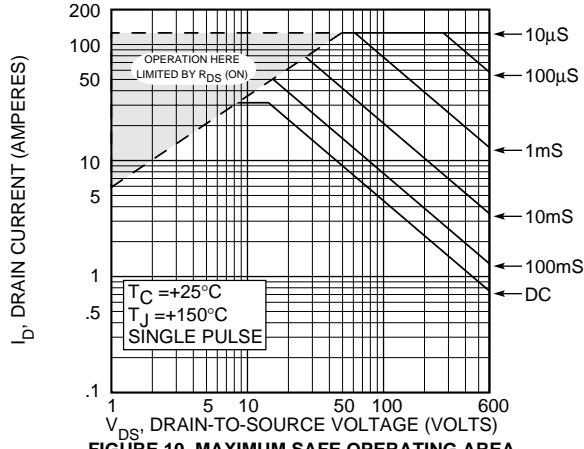

FIGURE 10, MAXIMUM SAFE OPERATING AREA

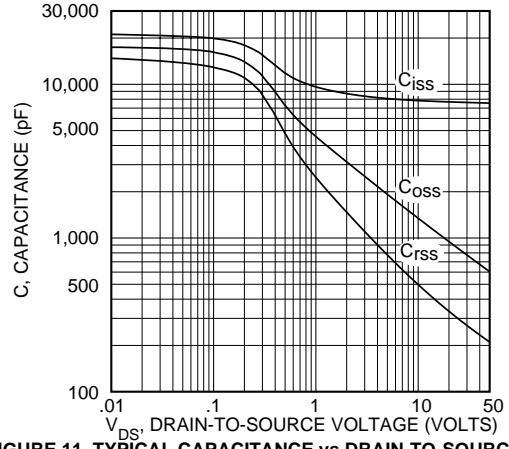

FIGURE 11, TYPICAL CAPACITANCE vs DRAIN-TO-SOURCE VOLTAGE

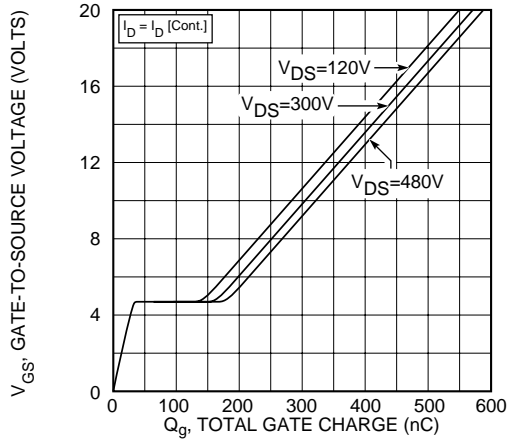

FIGURE 12, GATE CHARGES vs GATE-TO-SOURCE VOLTAGE

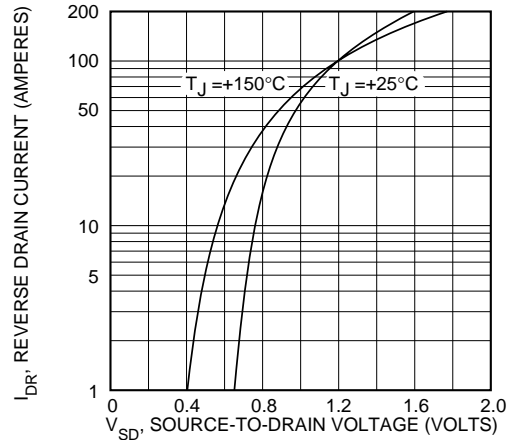
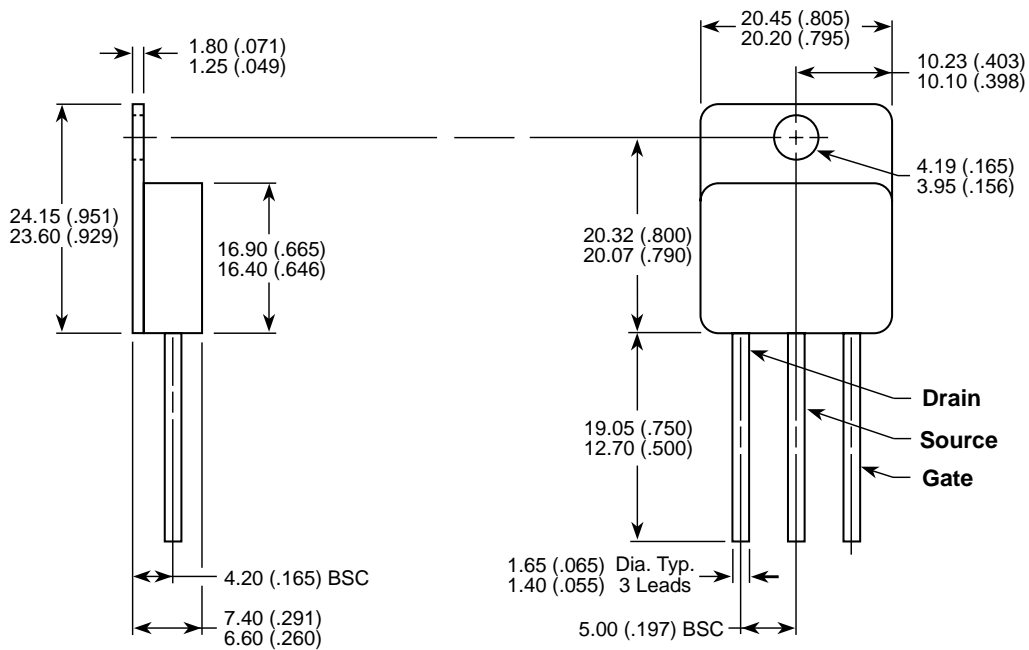

FIGURE 13, TYPICAL SOURCE-DRAIN DIODE FORWARD VOLTAGE

TO-267 Package Outline



Dimensions in Millimeters and (Inches)