

Selection Guide

Part No.	Dice	Lens Type	Iv (mcd) @ 20mA		Viewing Angle
			Min.	Typ.	θ1/2
APKA2810MGC	MEGA GREEN (InGaAlP)	WATER CLEAR	18	70	90°

Note:

1. θ1/2 is the angle from optical centerline where the luminous intensity is 1/2 the optical centerline value.

Electrical / Optical Characteristics at TA=25°C

Symbol	Parameter	Device	Typ.	Max.	Units	Test Conditions
λpeak	Peak Wavelength	Mega Green	574		nm	IF=20mA
λD	Dominant Wavelength	Mega Green	568		nm	IF=20mA
Δλ1/2	Spectral Line Half-width	Mega Green	26		nm	IF=20mA
C	Capacitance	Mega Green	20		pF	VF=0V;f=1MHz
VF	Forward Voltage	Mega Green	2.1	2.5	V	IF=20mA
IR	Reverse Current	Mega Green		10	uA	VR = 5V

Absolute Maximum Ratings at TA=25°C

Parameter	Mega Green	Units
Power dissipation	105	mW
DC Forward Current	30	mA
Peak Forward Current [1]	150	mA
Reverse Voltage	5	V
Operating/Storage Temperature	-40°C To +85°C	

Note:

1. 1/10 Duty Cycle, 0.1ms Pulse Width.

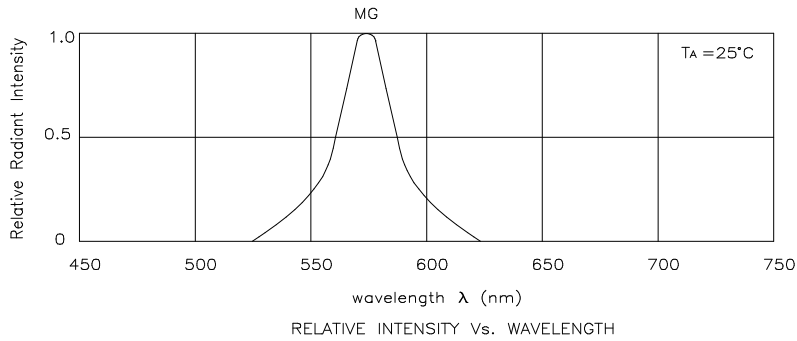

Mega Green

APKA2810MGC

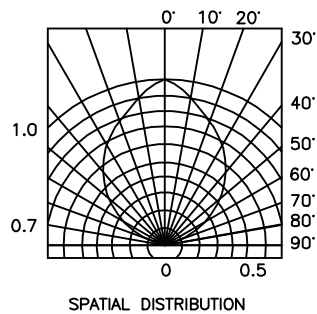
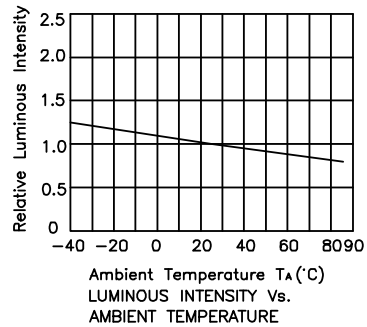
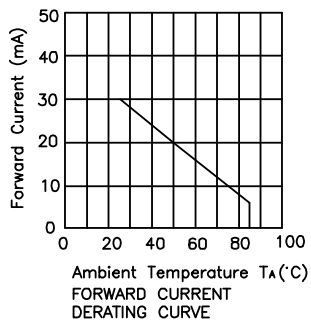
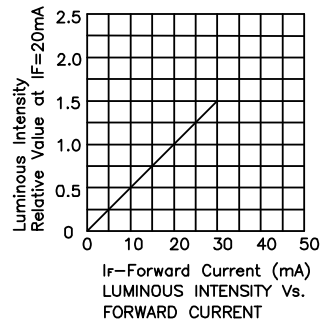
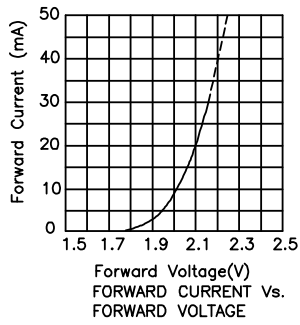

APKA2810MGC

Reflow Soldering Profile For Lead-free SMT Process.

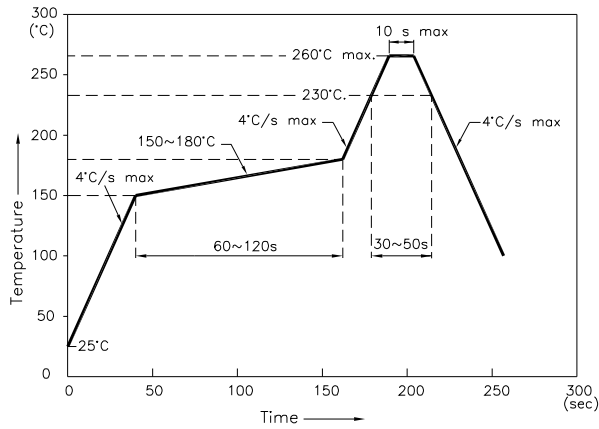

NOTES:

1. We recommend the reflow temperature 245°C(+/-5°C). The maximum soldering temperature should be limited to 260°C.
2. Don't cause stress to the epoxy resin while it is exposed to high temperature.
3. Number of reflow process shall be 2 times or less.

Recommended Soldering Pattern (Units : mm)

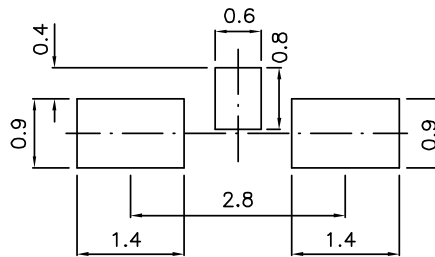

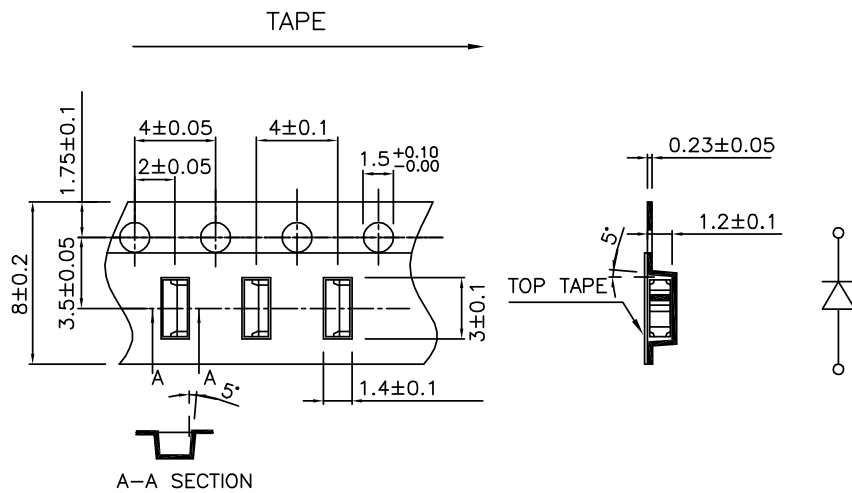

Tape Specifications (Units : mm)

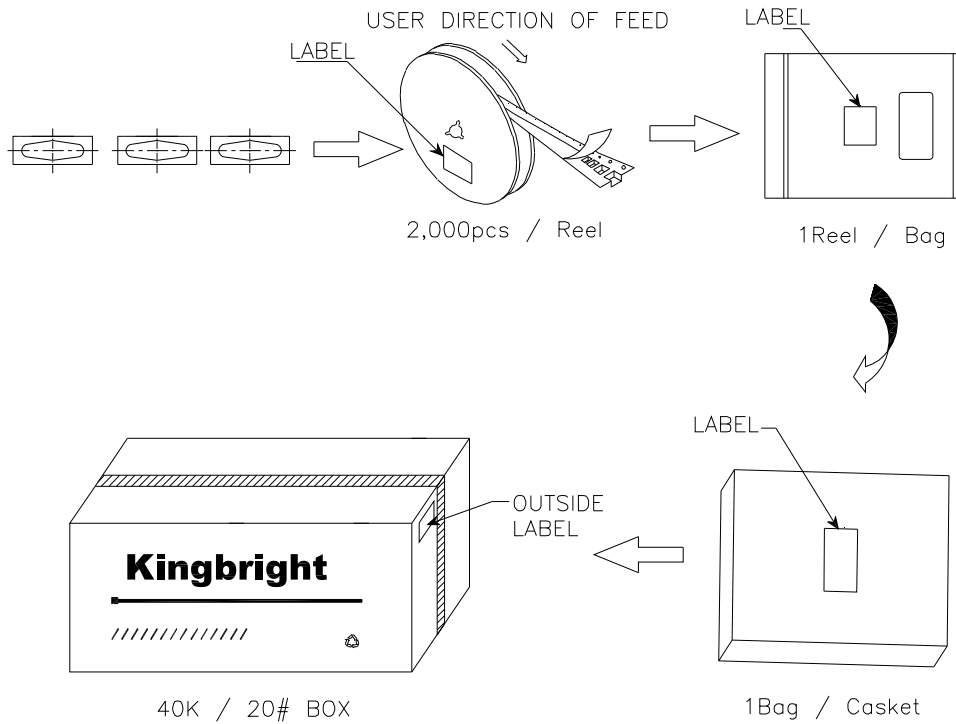

PACKING & LABEL SPECIFICATIONS

APKA2810MGC



Kingbright	
P/NO: APKA2810xxxx	
QTY: 2,000 pcs	Q.C. Q C xx xx xx PASSED
S/N: XXXX	
CODE: XXX	
LOT NO:	
	
RoHS Compliant	

Remarks:

If special sorting is required (e.g. binning based on forward voltage, luminous intensity, or wavelength), the typical accuracy of the sorting process is as follows:

1. Wavelength: +/-1nm
2. Luminous Intensity: +/-15%
3. Forward Voltage: +/-0.1V

Note: Accuracy may depend on the sorting parameters.