

FEATURES:

- High-speed, low-power voltage comparator
- RAD-PAK® radiation-hardened against natural space radiation
- Total dose hardness: 100 krad (Si) typical; dependent upon orbit
- 8ns typ propagation delay
- 18mW power consumption (typ at +5V)
- Separate analog and digital supplies
- Flexible analog supply: +5V to +10V or ±5V
- Input range includes negative supply rail
- TTL compatible outputs
- TTL compatible latch inputs

DESCRIPTION:

Maxwell Technologies' 903 high-speed, low-power voltage comparator features differential analog inputs and TTL logic outputs with active internal pull-ups. The 903 can be powered from separate analog and digital power supplies or from a single combined supply voltage. The analog input common-mode range includes the negative rail, allowing ground sensing when powered from a single supply. When powered from +5V, the 903 consumes 18mW. The 903 is equipped with a TTL compatible latch input. The comparator output is latched when the latch input is driven low. Capable of surviving space environments, the 903 is ideal for satellite, spacecraft, and space probe missions. Maxwell Technologies' patented RAD-PAK® packaging technology incorporates radiation shielding in the microcircuit package. It eliminates box shielding while providing lifetime in orbit or space mission. In GEO orbit, RAD-PAK® provides greater than 100 krad(Si) radiation dose rate. This product is available with screening up to Class S.

TABLE 1. PINOUT DESCRIPTION

PIN	NAME	FUNCTION
1	V _{CC}	Positive Analog Supply
2	IN+	Positive input
3	IN-	Negative input
4	V _{EE}	Negative analog supply and substrate
5	LATCH	Latch input
6	GND	Ground terminal
7	OUT	Output
8	V _{DD}	Positive digital supply

TABLE 2. ABSOLUTE MAXIMUM RATINGS

PARAMETER	MIN	MAX	UNITS
Analog Supply Voltage (V _{CC} to V _{EE})	--	+12	V
Digital Supply Voltage (V _{DD} to GND)	--	+7	V
Differential Input Voltage	V _{EE} - 0.2	V _{CC} + 0.2	V
Common-mode Input Voltage	V _{EE} - 0.2	V _{CC} + 0.2	V
Latch Input Voltage	-0.2	V _{DD} + 0.2	V
Output Short-circuit Duration to GND	Indefinite		
Output Short-circuit Duration to V _{DD}	--	1	min.
Operating Temperature Ranges	-55	+125	°C
Junction Temperature (T _j)	-65	+160	°C
Storage Temperature Range	-65	+150	°C

TABLE 3. AC ELECTRICAL CHARACTERISTICS

(V_{CC} = +5V, V_{EE} = -5V, LATCH = LOGIC HIGH, T_A = T_{MIN} TO T_{MAX}, UNLESS OTHERWISE SPECIFIED)

PARAMETER	SYMBOL	TEST CONDITIONS	SUBGROUPS	MIN	TYP	MAX	UNITS
Input-to-output High Response Time	tpd+	V _{OD} = 5mV, CL = 15pF, IO = 2mA ¹	9, 10, 11	--	10	15	ns
Input-to-output Low Response Time	tpd-	V _{OD} = 5mV, CL = 15pF, IO = 2mA ¹	9, 10, 11	--	10	15	ns

TABLE 3. AC ELECTRICAL CHARACTERISTICS

(V_{CC} = +5V, V_{EE} = -5V, LATCH = LOGIC HIGH, T_A = T_{MIN} TO T_{MAX}, UNLESS OTHERWISE SPECIFIED)

PARAMETER	SYMBOL	TEST CONDITIONS	SUBGROUPS	MIN	TYP	MAX	UNITS
Latch Disable to Output High Delay	tpd+	2	9, 10, 11		10		ns
Latch Disable to Output Low Delay	tpd-	2	9, 10, 11		12		ns
Minimum Setup Time	ts	2	9, 10, 11		2		ns
Minimum Hold Time	th	2	9, 10, 11		1		ns
Minimum Latch Disable Pulse Width	tpw	2	9, 10, 11		10		ns

1. Guaranteed by design.
2. Owing to the difficult and critical nature of switching measurements involving the latch, these parameters cannot be tested in a production environment. Typical specifications listed are taken from measurements using a high-speed test fixture.

TABLE 4. DC ELECTRICAL CHARACTERISTICS

(V_{CC} = +5V, V_{EE} = -5V, LATCH = LOGIC HIGH, T_A = T_{MIN} TO T_{MAX}, UNLESS OTHERWISE SPECIFIED)

PARAMETER	SYMBOL	TEST CONDITIONS	SUBGROUPS	MIN	TYP	MAX	UNITS
Input Offset Voltage	V _{OS}	V _{CM} = 0V, V _O = 1.4V	1, 2, 3	--	2	6	mV
Input Bias Current	I _B	I _{IN+} or I _{IN-}	1, 2, 3	--	6	15	μA
Input Offset Current	I _{OS}	V _{CM} = 0V, V _O = 1.4V	1, 2, 3	--	200	800	nA
Input Voltage Range	V _{CM}	1	1, 2, 3	V _{EE} - 0.1	--	V _{CC} - 2.25	V
Common-mode Rejection Ratio	CMRR	-5V < V _{CM} < +2.75, V _O = 1.4V, ²	1, 2, 3	--	120	500	μV/V
Power-supply Rejection Ratio	PSRR	2	1, 2, 3	--	150	500	μV/V
Output High Voltage	V _{OH}	V _{IN} > 250mV, I _{SRC} = 1mA	1, 2, 3	2.4	3.5	--	V
Output Low Voltage	V _{OL}	V _{IN} > 250mV, I _{SINK} = 8mA	1, 2, 3	--	0.3	0.4	V
Latch Input Voltage High	V _{LH}		1, 2, 3	--	1.4	2.0	V
Latch Input Voltage Low	V _{LL}		1, 2, 3	0.8	1.4	--	V
Latch Input Current High	I _{LH}	V _{LH} = 3.0V	1, 2, 3	--	1	20	μA
Latch Input Current Low	I _{LL}	V _{LL} = 0.3V	1, 2, 3	--	1	20	μA

TABLE 4. DC ELECTRICAL CHARACTERISTICS

(V_{CC} = +5V, V_{EE} = -5V, LATCH = LOGIC HIGH, T_A = T_{MIN} TO T_{MAX} UNLESS OTHERWISE SPECIFIED)

PARAMETER	SYMBOL	TEST CONDITIONS	SUBGROUPS	MIN	TYP	MAX	UNITS
Positive Analog Supply Current	I _{CC}		1, 2, 3	--	2.5	6	mA
Negative Analog Supply Current	I _{EE}		1, 2, 3	--	2	5	mA
Digital Supply Current	I _{DD}		1, 2, 3	--	1	2.5	mA
Power Dissipation	P _D	V _{CC} = V _{DD} = +5V, V _{EE} = 0V	1, 2, 3	--	18	28	mW

1. The input common-mode voltage or either input signal voltage should not be allowed to go negative by more than 0.2V below V_{EE}. The upper end of the common-mode voltage range is typically V_{CC} - 0.2V, but either or both inputs can go to a maximum of V_{CC} + 0.2V without damage.
2. Tested for +4.75V < V_{CC} < +5.25V, and -5.25V < V_{EE} < -4.75V with V_{DD} = +5V, although permissible analog power-supply range is +4.75V < V_{CC} < +10.5V for single-supply operation with V_{EE} grounded.

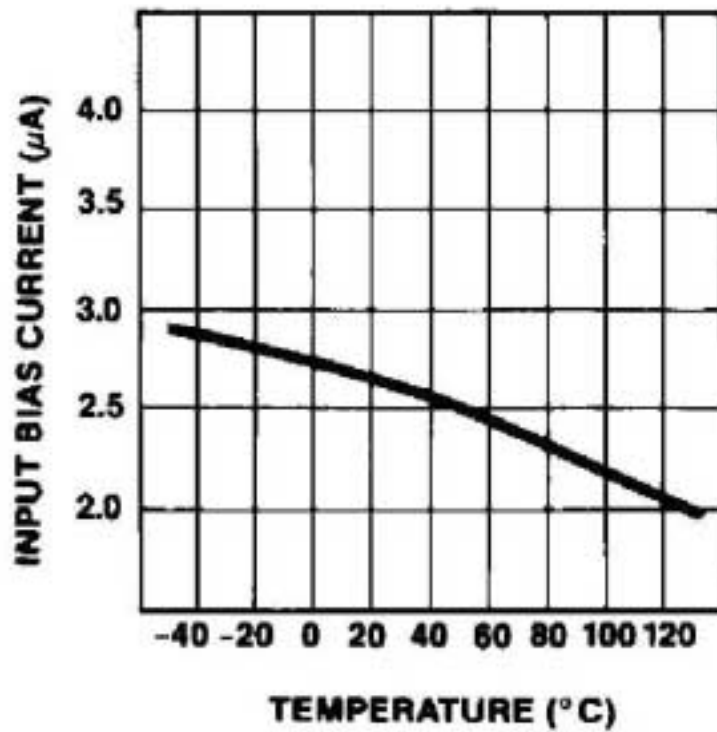

FIGURE 3. OUTPUT LOW VOLTAGE (V_{OL}) vs. LOAD CURRENT

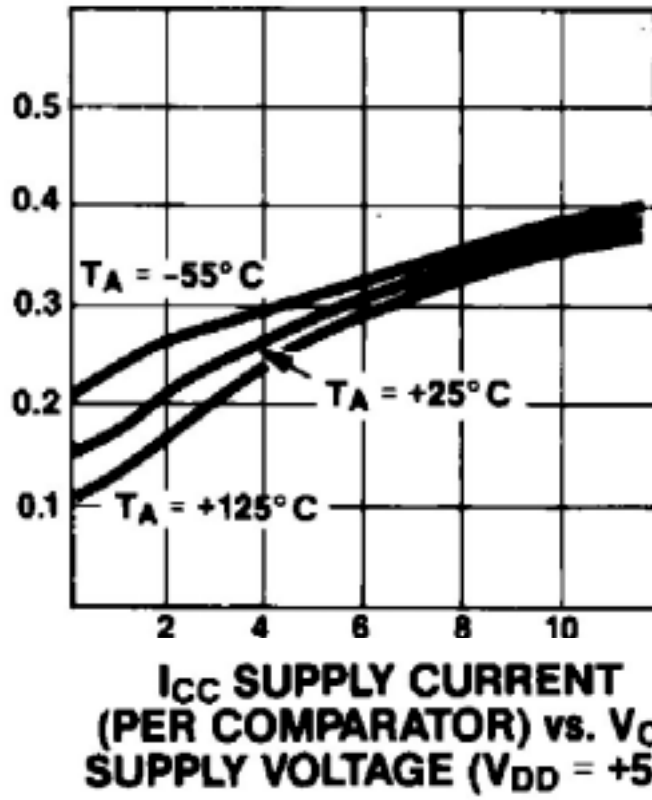

FIGURE 4. I_{CC}

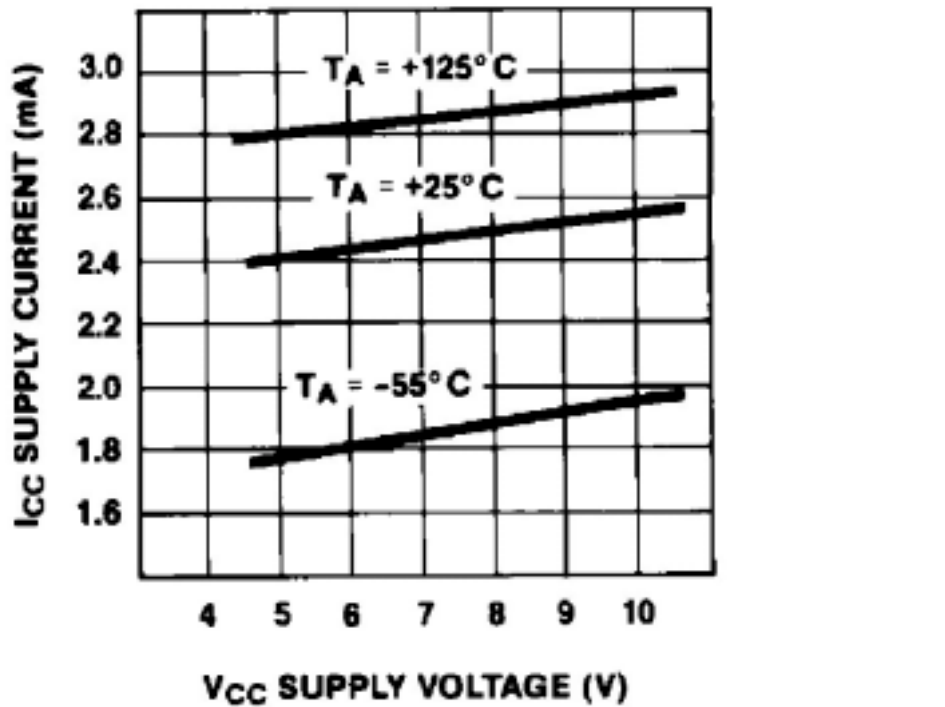

FIGURE 5. INPUT OVERDRIVE VS. t_{pd+} RESPONSE TIME

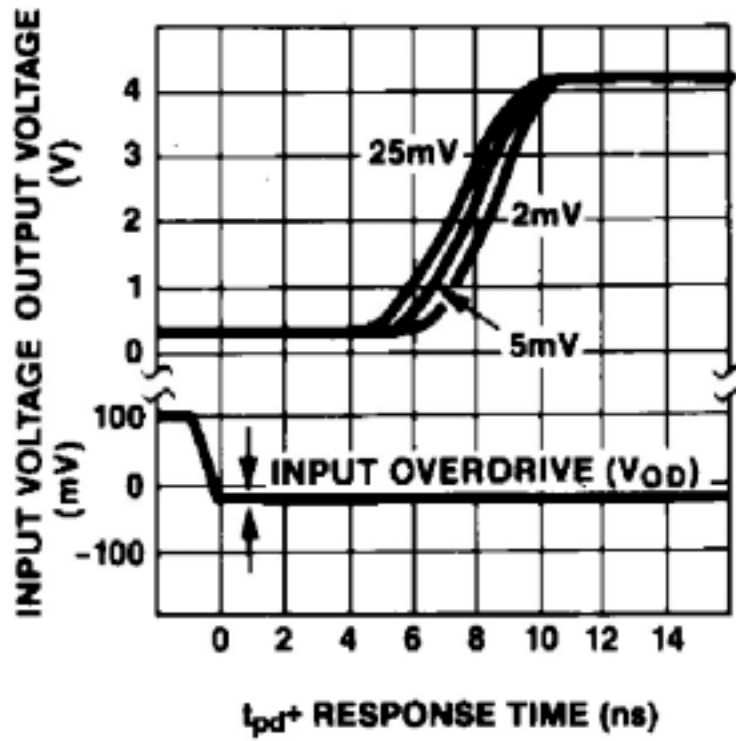

FIGURE 6. INPUT OVERDRIVE VS. t_{pd-} RESPONSE TIME

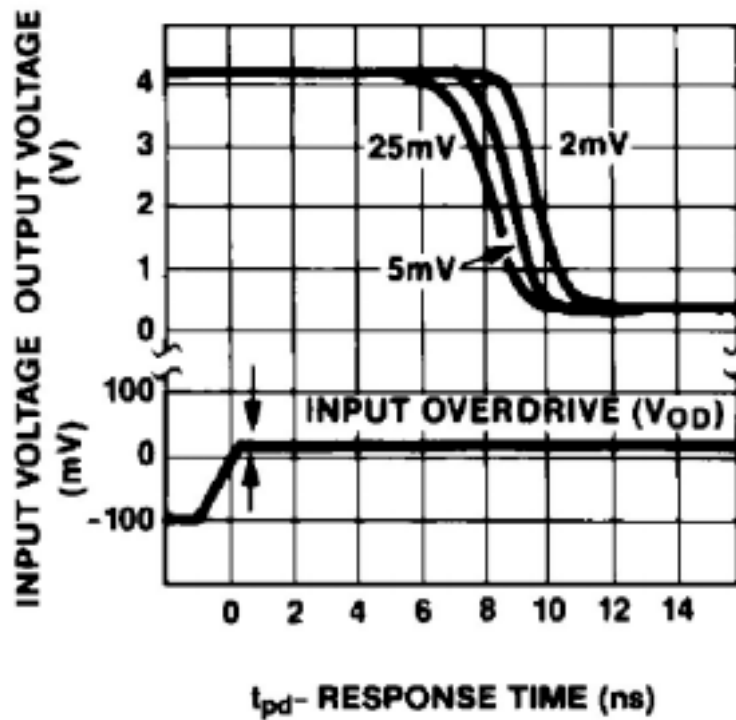

FIGURE 7. RESPONSE TIME VS. TEMPERATURE (5M_V OVERDRIVE)

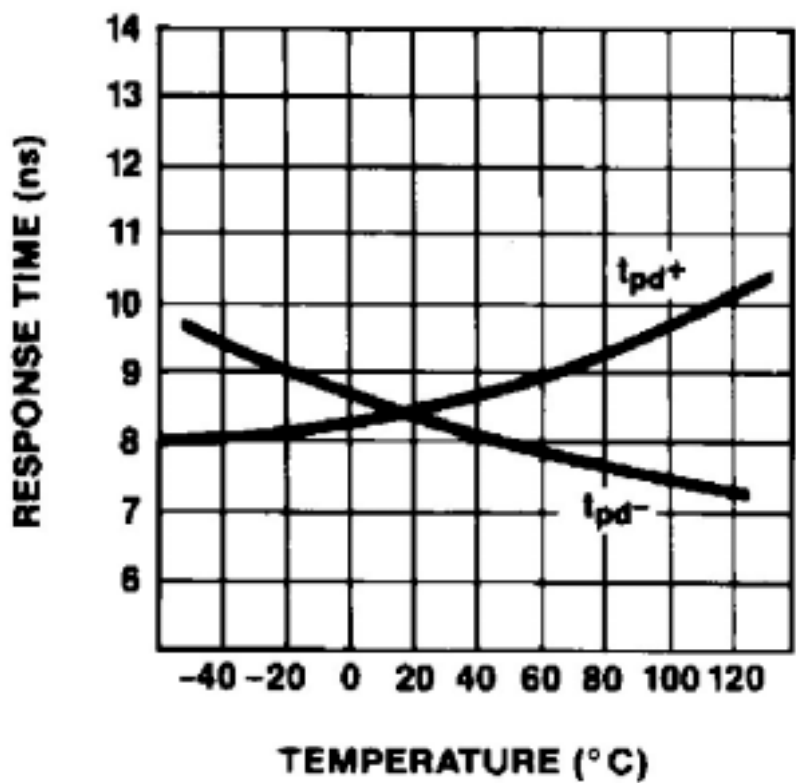

FIGURE 8. RESPONSE TIME VS. LOAD CAPACITANCE (5M_V OVERDRIVE, R_{LOAD} = 2.4k Ω)

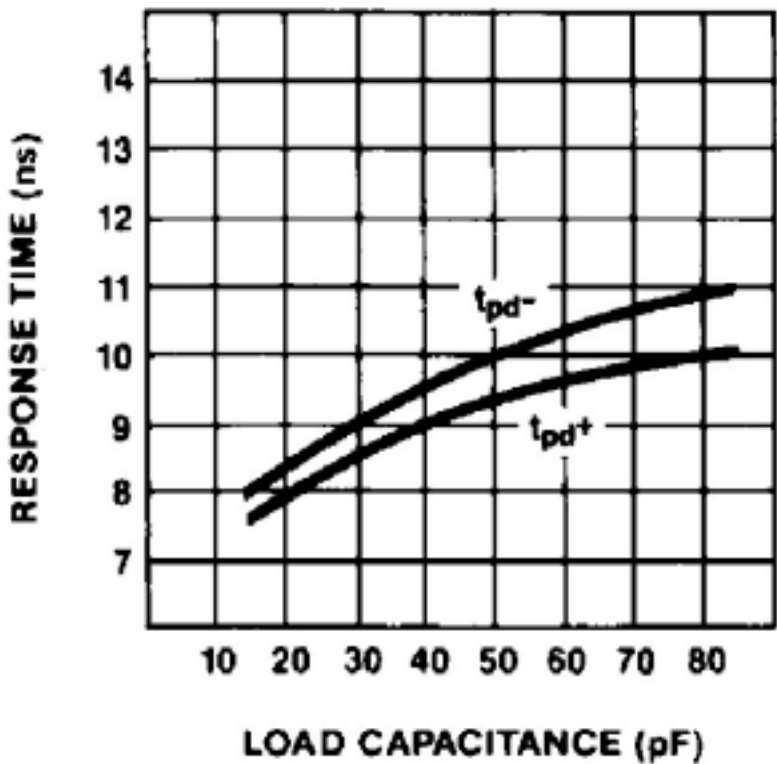

FIGURE 9. TIMING DIAGRAM

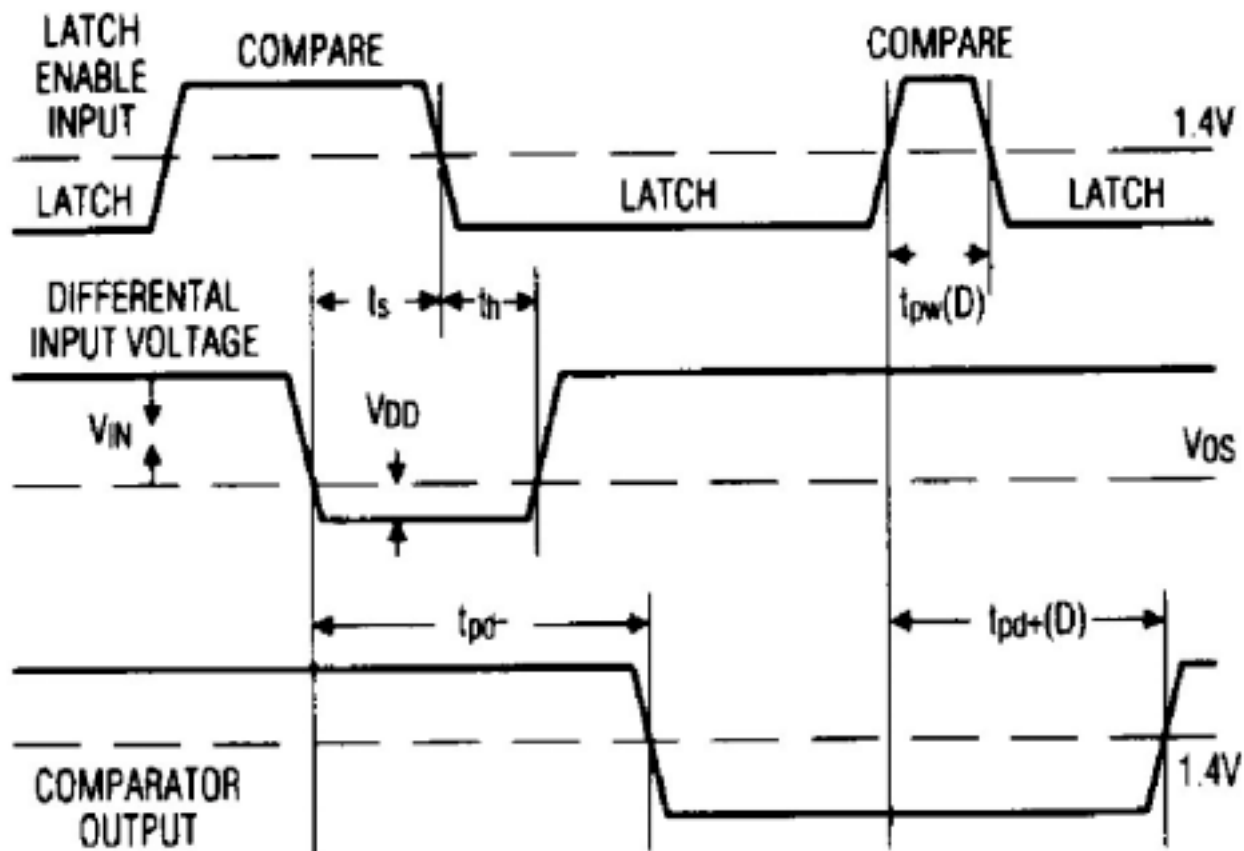

FIGURE 10. t_{bd+} RESPONSE TIME TO 5mV OVERDRIVE

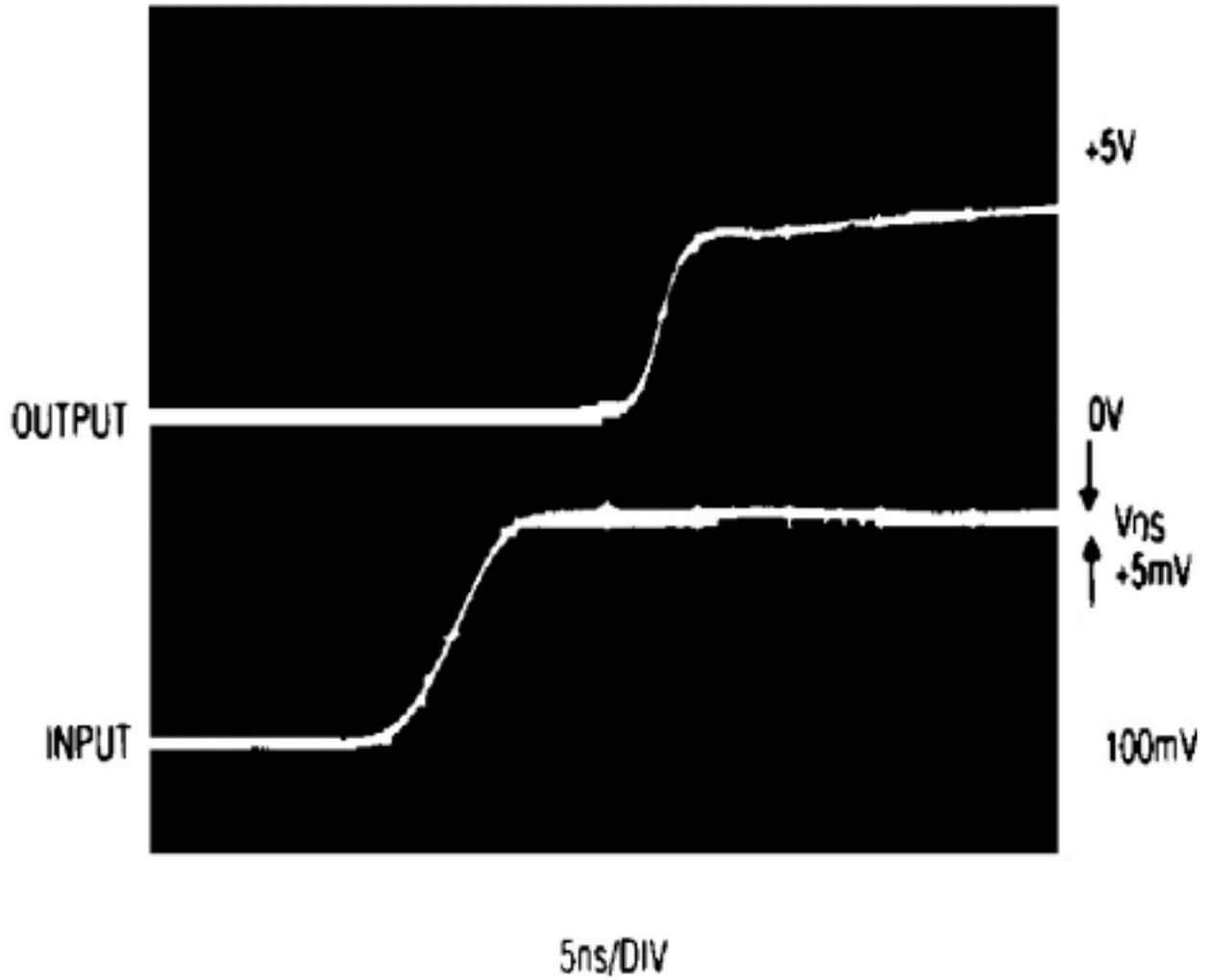

FIGURE 11. t_{pd} - RESPONSE TIME TO 5mV O

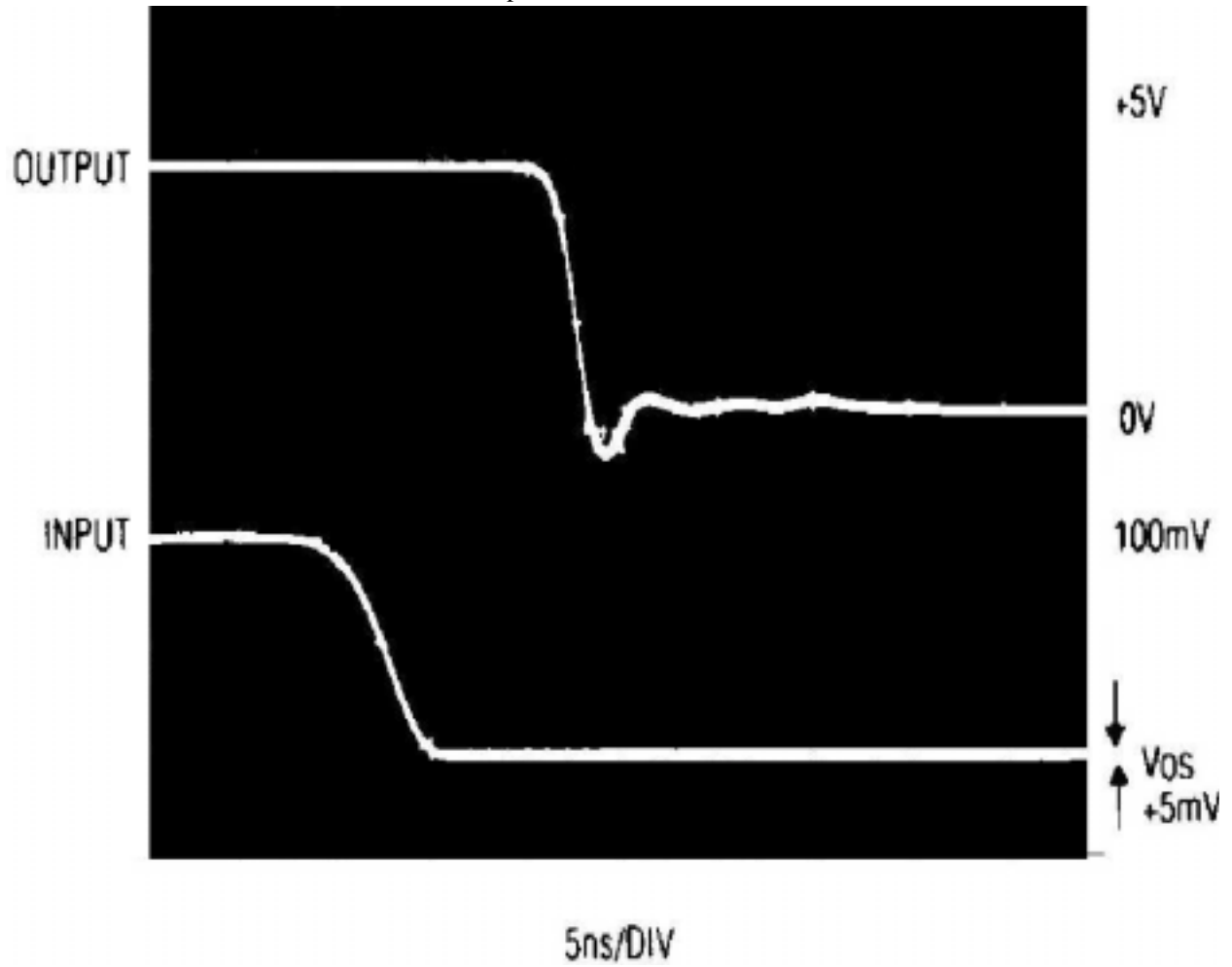
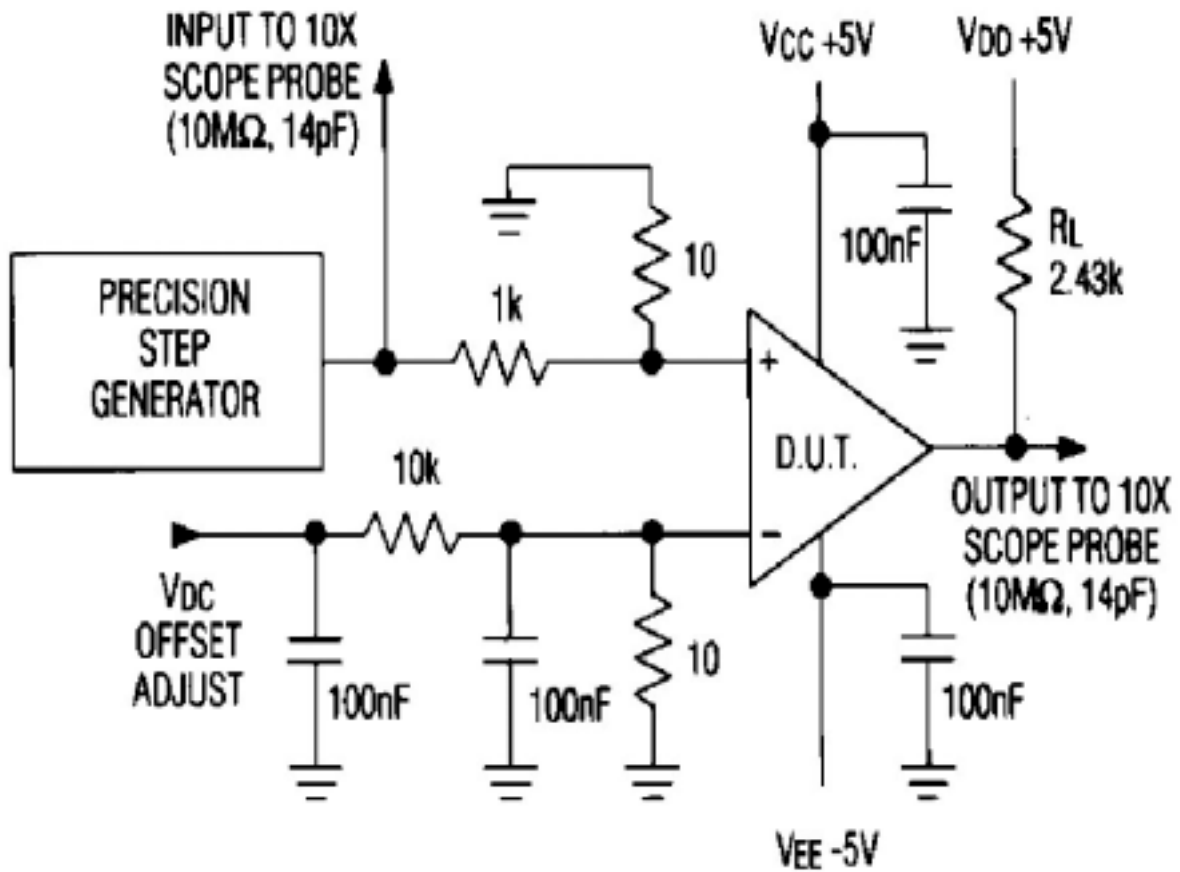

FIGURE 12. RESPONSE-TIME SETUP



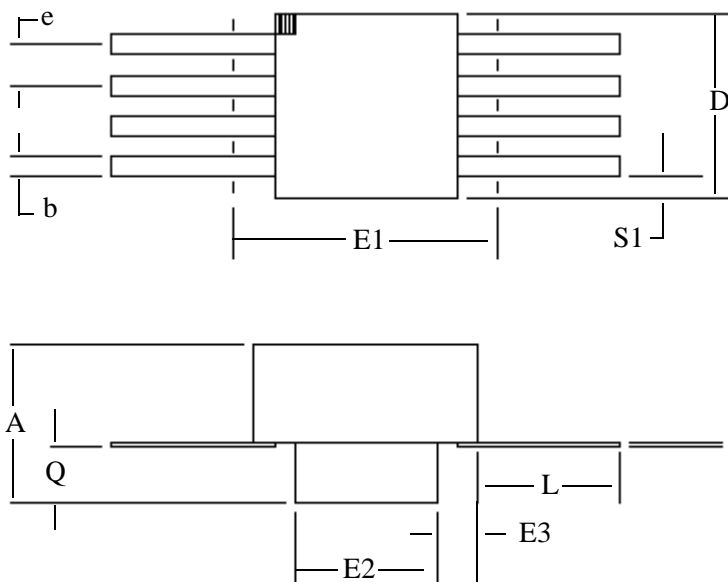

TABLE 13. 8 LEAD RAD-PAK FLAT PACKAGE

SYMBOL	DIMENSIONS		
	MIN	NOM	MAX
A	.209	.227	.245
b	.015	.017	.019
c	.004	.005	.006
D	.250	.255	.260
E	.250	.255	.260
E1			.290
E2	.140	.145	.150
E3	.045	.055	--
e	.050 BSC		
L	.338	.348	.358
Q	.066	.070	.074
S1	.005	.044	--
N	8		

Important Notice:

These data sheets are created using the chip manufacturer's published specifications. Maxwell Technologies verifies functionality by testing key parameters either by 100% testing, sample testing or characterization.

The specifications presented within these data sheets represent the latest and most accurate information available to date. However, these specifications are subject to change without notice and Maxwell Technologies assumes no responsibility for the use of this information.

Maxwell Technologies' products are not authorized for use as critical components in life support devices or systems without express written approval from Maxwell Technologies.

Any claim against Maxwell Technologies must be made within 90 days from the date of shipment from Maxwell Technologies. Maxwell Technologies' liability shall be limited to replacement of defective parts.

Product Ordering Information

